

THE CONNECTION | POLYCAB HIGH TENSION CABLE
powering India's growth



BRANCH OFFICES

Sales Representatives:
Polycab Australia Pvt. Ltd. (PAPL)
Unit 55, 117 Old Pittwater Road, Brookvale, NSW 2100, Australia

Sales Representatives:
Polycab USA LLC (PULLC)
The Corporate Trust Company, Corporation Trust Centre, 1209 Orange Street, Wilmington, Delaware 19801

Email Addresses for Contact:
AUSTRALIA : sales.australia@polycab.com | USA : polycab.usa@polycab.com | KOREA : sales.korea@polycab.com
ITALY : sales.italy@polycab.com | SPAIN : sales.spain@polycab.com | EXPORTS : exports@polycab.com

Corporate Office:
POLYCAB INDIA LIMITED
29, The Ruby, 21st Floor, Senapati Bapat Marg, Tulsi Pipe Road, Dadar (West),
Mumbai – 400028, Maharashtra (India)
Ph.: +91-22-2432 7070/4, 6735 1400, Email: enquiry@polycab.com, Toll Free No.: 1800 267 0008

Follow us on: [f](#) @PolycabInd | [@](#) polycabindia | [X](#) @PolycabIndia | [v](#) @PolycabInd | [in](#) @PolycabIndia





CONTENTS

- 01 Company Introduction
- 02 Introduction to Polycab
- 03 Process flow digram
- 04 Material handling
- 05 Quality planning
- 06 Company Introduction
- 07 Introduction to Polycab
- 08 Process flow digram
- 09 Material handling
- 10 Quality planning

Introduction

Polycab, India's leading wires and cables manufacturing company, has earned the trust of millions of customers over the last five decades. It has a range of products for practically every application and voltage grades between 0.5 KV to 220 KV. Having cemented its leadership in India and Southeast Asia, the company now supplies a variety of Power, Control, Instrumentation, and communication cables to more than 44 countries globally, including the

continents of Europe and America.

This catalogue will help you to get familiar with Polycab's High Tension cable range and discover how they fulfill your industry needs.





Scan to watch
Polycab HT cable
manufacturing video



Polycab, with voltage grade ranging from 1.9/3.3 kV to 19/33 kV, are used for supplying power to wide networks such as commercial, industrial and urban/ residential. These cables are available with XLPE/EPR insulation and have a temperature rating of 90°C and 105°C respectively.

The cables are halogen free, flame retardant and provide continuous load and extra protection from short circuit and fire.

Conductor: The high conductivity annealed plain stranded compacted aluminium/copper conductor is produced in-house with highly advanced machines.

Conductor Screen: It's an extruded layer of semi-conducting compound that eliminates the risk of electric discharge at the interface between conductor and insulation. It also prevents electrical stress concentrations on the surface of the conductor.

Insulation: The cross-linked polyethylene thermoset insulation compound, developed in-house, provides high degree of insulation resistance.

Non-metallic Insulation Screen: An extruded layer of cross-linked semi-conducting compound, it forms the third protective layer after conductor screen and insulation. The screen eliminates micro voids and curing, thus extending the life of the cable.

Metallic Screen: A helically applied copper tape screen to carry faulty current.

Laying Up: In case of 3 Core Cable, insulated cores are laid up together with fillers, developed in-house, to maintain circularity of cable and optional ground wire for earthing purpose.

Inner Sheath: A thermoplastic, halogen free PVC compound, developed in-house, it emits less smoke and corrosive gases when exposed to fire. The sheath also maintains the circular shape of cable.

Optional Metallic Sheath: Lead Alloy.

Optional Insect Attack Protective Layer: Polyamide Nylon.

Outer Sheath: Developed in-house, this thermoplastic compound emits less smoke and corrosive gases when exposed to fire.

The construction is based on the application and requirement of the user against AS/NZS 1429.1.



POLY CAB SINGLE CORE MV AS/NZS
1429.1 1.9/3.3 (3.6) KV (Copper)



POLY CAB SINGLE CORE ANTI-TERMITE MV AS/NZS
1429.1 1.9/3.3 (3.6) KV (Aluminium)



POLY CAB SINGLE CORE MV AS/NZS
1429.1 3.8/6.6 (7.2) KV (Aluminium)



POLY CAB SINGLE CORE MV AS/NZS
1429.1 6.35/11 (12) KV (Copper)



POLY CAB SINGLE CORE ANTI-TERMITE MV AS/NZS
1429.1 6.35/11 (12) KV (Aluminium)



POLY CAB SINGLE CORE MV AS/NZS
1429.1 12.7/22 (24) KV (Aluminium)



POLY CAB SINGLE CORE MV AS/NZS
1429.1 19/33 (36) KV (Copper)



POLY CAB SINGLE CORE ANTI-TERMITE MV AS/NZS
1429.1 19/33 (36) KV (Aluminium)



POLY CAB SINGLE CORE MV AS/NZS
1429.1 1.9/3.3 (3.6) KV (Aluminium)



POLY CAB SINGLE CORE MV AS/NZS
1429.1 3.8/6.6 (7.2) KV (Copper)



POLY CAB SINGLE CORE ANTI-TERMITE MV AS/NZS
1429.1 3.8/6.6 (7.2) KV (Aluminium)



POLY CAB SINGLE CORE MV AS/NZS
1429.1 6.35/11 (12) KV (Aluminium)



POLY CAB SINGLE CORE MV AS/NZS
1429.1 12.7/22 (24) KV (Copper)



POLY CAB SINGLE CORE ANTI-TERMITE MV AS/NZS
1429.1 12.7/22 (24) KV (Aluminium)



POLY CAB SINGLE CORE MV AS/NZS
1429.1 19/33 (36) KV (Aluminium)



POLY CAB THREE CORE MV AS/NZS
1429.1 1.9/3.3 (3.6) KV (Copper)



POLYCAB SINGLE CORE MV AS/NZS
1429.1 1.9/3.3 (3.6) KV (Copper)



POLYCAB THREE CORE MV AS/NZS
1429.1 1.9/3.3 (3.6) KV (Copper)



POLYCAB THREE CORE MV AS/NZS
1429.1 19/33 (36) KV (Aluminium)



POLYCAB THREE CORE ANTI-TERMITE MV AS/NZS
1429.1 19/33 (36) KV (Aluminium)



POLYCAB THREE CORE MV AS/NZS
1429.1 1.9/3.3 (3.6) KV (Aluminium)



POLYCAB THREE CORE ANTI-TERMITE MV AS/NZS
1429.1 1.9/3.3 (3.6) KV (Aluminium)



POLYCAB TRIPLEX MV AS/NZS
1429.1 3.8/6.6 (7.2) KV (Copper)



POLYCAB TRIPLEX MV AS/NZS
1429.1 3.8/6.6 (7.2) KV (Aluminium)



POLYCAB THREE CORE MV AS/NZS
1429.1 3.8/6.6 (7.2) KV (Copper)



POLYCAB THREE CORE MV AS/NZS
1429.1 3.8/6.6 (7.2) KV (Aluminium)



POLYCAB TRIPLEX ANTI-TERMITE MV AS/NZS
1429.1 3.8/6.6 (7.2) KV (Aluminium)



POLYCAB TRIPLEX MV AS/NZS
1429.1 6.35/11 (12) KV (Copper)



POLYCAB THREE CORE ANTI-TERMITE MV AS/NZS
1429.1 3.8/6.6 (7.2) KV (Aluminium)



POLYCAB THREE CORE MV AS/NZS
1429.1 6.35/11 (12) KV (Copper)



POLYCAB TRIPLEX MV AS/NZS
1429.1 6.35/11 (12) KV (Aluminium)



POLYCAB TRIPLEX ANTI-TERMITE MV AS/NZS
1429.1 6.35/11 (12) KV (Aluminium)



POLYCAB THREE CORE MV AS/NZS
1429.1 6.35/11 (12) KV (Aluminium)



POLYCAB THREE CORE ANTI-TERMITE MV AS/NZS
1429.1 6.35/11 (12) KV (Aluminium)



POLYCAB TRIPLEX MV AS/NZS
1429.1 12.7/22 (24) KV (Copper)



POLYCAB TRIPLEX MV AS/NZS
1429.1 12.7/22 (24) KV (Aluminium)



POLYCAB THREE CORE MV AS/NZS
1429.1 12.7/22 (24) KV (Copper)



POLYCAB THREE CORE MV AS/NZS
1429.1 12.7/22 (24) KV (Aluminium)



POLYCAB TRIPLEX ANTI-TERMITE MV AS/NZS
1429.1 12.7/22 (24) KV (Aluminium)



POLYCAB TRIPLEX MV AS/NZS
1429.1 19/33 (36) KV (Copper)



POLYCAB THREE CORE ANTI-TERMITE MV AS/NZS
1429.1 12.7/22 (24) KV (Aluminium)



POLYCAB THREE CORE MV AS/NZS
1429.1 19/33 (36) KV (Copper)



POLYCAB TRIPLEX MV AS/NZS
1429.1 19/33 (36) KV (Aluminium)



POLYCAB TRIPLEX ANTI-TERMITE MV AS/NZS
1429.1 19/33 (36) KV

POLYCAB SINGLE CORE MV AS/NZS 1429.1 1.9/3.3 (3.6) KV
MV Cable with Copper Conductor, XLPE Insulation, Copper Screen and Unarmoured

POLYCAB SINGLE CORE MV AS/NZS 1429.1 1.9/3.3 (3.6) KV
MV Cable with Copper Conductor, XLPE Insulation, Copper Screen and Unarmoured

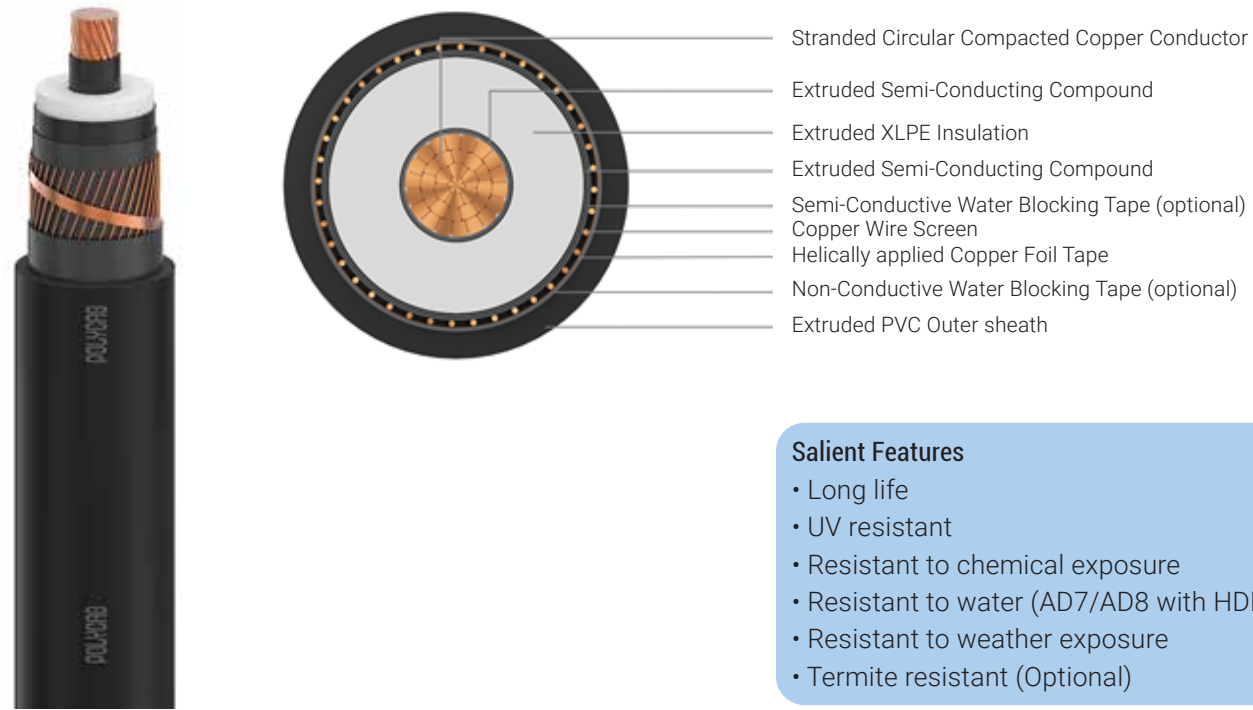

- Salient Features**
- Long life
 - UV resistant
 - Resistant to chemical exposure
 - Resistant to water (AD7/AD8 with HDPE)
 - Resistant to weather exposure
 - Termite resistant (Optional)

Application
POLYCAB MV 1.9/3.3 KV XLPE insulated with Copper conductor single core cable is suitable to use for power supply to wide networks i.e. Commercial, Industrial and Urban / Residential.

Voltage Rating
Nominal Voltage: 1.9/3.3 (3.6) kV

Operation Temperature
Min. installation temperature: 0°C
Operating temperature: -25°C to +90°C
Emergency operating temperature: 105°C
(max. operation of 36hrs, at 3 periods for 12 consecutive months use)
Max. Short Circuit Temperature: 250°C

Construction

- Conductor: Stranded Compacted Circular Copper conductor as per AS/NZS 1125
- Conductor Screen: Extruded Semi-conductive compound
- Insulation: XLPE
- Insulation Screen: Extruded Semi-conductive compound
- Longitudinal Water blocking : Water blocking tape above and below copper screen (Optional)
- Metallic Insulation Screen: Copper Wire Screen + helicly applied copper tape (E/F current capacity – Based on requirement)
- Metallic Sheath: Lead Alloy (optional)
- Outer Sheath: Extruded Polyvinyl Chloride, Colour: Black
- Termite Protection: Polyamide (Nylon -12) (optional)
(Alternative Sheath: PVC+HDPE Composite Sheath or PVC + Nylon + HDPE (composite sheath with anti-termite properties) or LSZH Outer sheath, and parameters will change accordingly)

Bending Radius:
Fixed Installation: 12D (PVC) / 15D (HDPE)/20D (Nylon)
During Installation: 18D (PVC) / 25D (HDPE)/30D (Nylon)

D is overall diameter of cable

Standard and References:
AS/NZS 1429.1
AS/NZS 1125
AS/NZS 3808

High Voltage Test
6.5 kV AC

Compliance

- Conductor resistance AS/NZS 1125
- Insulation resistance AS/NZS 1429.1
- Voltage test AS/NZS 1429.1



DIMENSIONAL CHARACTERISTICS:

Product Code	No. of Cores	Core Cross sectional Area	Nominal Diameter		
			Under metallic screen	Over metallic screen	Overall
	No.	mm ²	mm	mm	mm
MVNZ10CXUAPH001C016SAXXXX	1	16	11.9	13.8	18.0
MVNZ10CXUAPH001C025SAXXXX	1	25	13.1	15.0	19.0
MVNZ10CXUAPH001C035SAXXXX	1	35	14.1	16.0	20.0
MVNZ10CXUAPH001C050SAXXXX	1	50	15.2	17.1	21.0
MVNZ10CXUAPH001C070SAXXXX	1	70	16.9	18.8	23.0
MVNZ10CXUAPH001C095SAXXXX	1	95	18.4	20.3	24.0
MVNZ10CXUAPH001C120SAXXXX	1	120	20.0	21.9	26.0
MVNZ10CXUAPH001C150SAXXXX	1	150	21.4	23.3	27.0
MVNZ10CXUAPH001C185SAXXXX	1	185	23.1	25.0	29.0
MVNZ10CXUAPH001C240SAXXXX	1	240	25.4	27.3	31.0
MVNZ10CXUAPH001C300SAXXXX	1	300	27.4	29.3	34.0
MVNZ10CXUAPH001C400SAXXXX	1	400	30.2	32.1	37.0
MVNZ10CXUAPH001C500SAXXXX	1	500	34.0	35.9	41.0
MVNZ10CXUAPH001C630SAXXXX	1	630	38.0	39.9	45.0
MVNZ10CXUAPH001C800SAXXXX	1	800	42.1	44.0	49.0
MVNZ10CXUAPH001C01KSAXXXX	1	1000	46.8	48.7	54.0

• Above mentioned parameters are based on 3kA/sec earth fault current capacity of copper screen



OUR CERTIFICATION
ISO 9001 | ISO 14001 | ISO 45001



OUR CERTIFICATION
ISO 9001 | ISO 14001 | ISO 45001



POLYCAB SINGLE CORE MV AS/NZS 1429.1 1.9/3.3 (3.6) KV
MV Cable with Copper Conductor, XLPE Insulation, Copper Screen and Unarmoured

ELECTRICAL CHARACTERISTICS:

No. of Cores	Core Cross sectional Area	Max. DC Resistance at 20°C	Max. AC Resistance at 90°C	Approx. Capacitance	Approx. Inductance	Approx. Reactance	Continuous Current Rating					
							In ground at 20°C		In Duct at 20°C		In air at 30°C	
							Flat	Trefoil	Flat	Trefoil	Flat	Trefoil
No.	mm ²	Ω/km	Ω/km	μF/km	mH/km	Ω/km	Amps					
1	16	1.15	1.466	0.26	0.463	0.146	113	109	104	103	128	125
1	25	0.727	0.927	0.3	0.431	0.135	144	140	133	132	167	163
1	35	0.524	0.668	0.34	0.411	0.129	172	166	159	157	203	198
1	50	0.387	0.494	0.38	0.392	0.123	203	196	188	186	243	238
1	70	0.268	0.342	0.44	0.360	0.113	246	239	229	227	303	296
1	95	0.193	0.247	0.49	0.345	0.108	293	285	274	271	369	361
1	120	0.153	0.196	0.55	0.328	0.103	332	323	311	308	426	417
1	150	0.124	0.159	0.59	0.318	0.100	366	361	347	343	481	473
1	185	0.0991	0.128	0.65	0.308	0.097	410	406	391	387	550	543
1	240	0.0754	0.098	0.73	0.298	0.094	470	469	453	447	647	641
1	300	0.0601	0.079	0.8	0.289	0.091	524	526	510	504	739	735
1	400	0.047	0.064	0.9	0.280	0.088	572	590	571	564	837	845
1	500	0.0366	0.051	0.93	0.274	0.086	660	655	640	635	970	960
1	630	0.0283	0.042	0.96	0.268	0.084	735	730	715	710	1110	1100
1	800	0.0221	0.035	0.99	0.263	0.083	770	820	800	790	1260	1250
1	1000	0.0176	0.031	1.04	0.259	0.081	825	885	865	855	1420	1410

*: Current Ratings are based on IEC 60502-2 & IEC 60287, Max. Conductor Temperature at 90°C, Ambient temperature at 30°C in Air / at 20°C in Ground, Thermal resistivity of Soil 1.5 k.m/W & for earthenware ducts 1.2k.m/W and Depth of Laying 0.8m.

Current rating de-rating factors for other than 30°C ambient air temperature.

20	25	35	40	45	50	55	60
1.08	1.04	0.96	0.91	0.87	0.82	0.76	0.71

Current rating de-rating factors for other than 20°C ground temperature.

10	15	25	30	35	40	45	50
1.07	1.04	0.96	0.93	0.89	0.85	0.80	0.76

POLYCAB SINGLE CORE MV AS/NZS 1429.1 1.9/3.3 (3.6) KV
MV Cable with Copper Conductor, XLPE Insulation, Copper Screen and Unarmoured

No. of Cores	Core Cross sectional Area	Max. pulling tension on conductor	Charging Current per phase	Zero sequence impedance	Electric Stress at Conductor Screen	Short circuit rating of Phase conductor
No.	mm ²	kN	Amps/Km	Ohms/Km	kV/mm	kA, 1 sec
1	16	1.1	0.16	2.63	1.3	2.3
1	25	1.75	0.18	2.09	1.2	3.6
1	35	2.45	0.2	1.83	1.2	5.0
1	50	3.5	0.23	1.65	1.1	7.2
1	70	4.9	0.26	1.50	1.1	10.0
1	95	6.65	0.29	1.41	1.1	13.6
1	120	8.4	0.33	1.36	1.1	17.1
1	150	10.5	0.35	1.32	1.1	21.4
1	185	12.95	0.39	1.29	1.1	26.4
1	240	16.8	0.44	1.26	1.0	34.3
1	300	21	0.48	1.24	1.0	42.8
1	400	28	0.54	1.22	1.0	56.9
1	500	35	0.56	1.21	0.9	71.5
1	630	44.1	0.57	1.20	0.9	90.2
1	800	56	0.59	1.19	0.8	114
1	1000	70	0.62	1.19	0.7	143



OUR CERTIFICATION
 ISO 9001 | ISO 14001 | ISO 45001



OUR CERTIFICATION
 ISO 9001 | ISO 14001 | ISO 45001



POLYCAB SINGLE CORE MV AS/NZS 1429.1 1.9/3.3 (3.6) KV
MV Cable with Aluminium Conductor, XLPE Insulation, Copper Screen and Unarmoured

POLYCAB SINGLE CORE MV AS/NZS 1429.1 1.9/3.3 (3.6) KV
MV Cable with Aluminium Conductor, XLPE Insulation, Copper Screen and Unarmoured

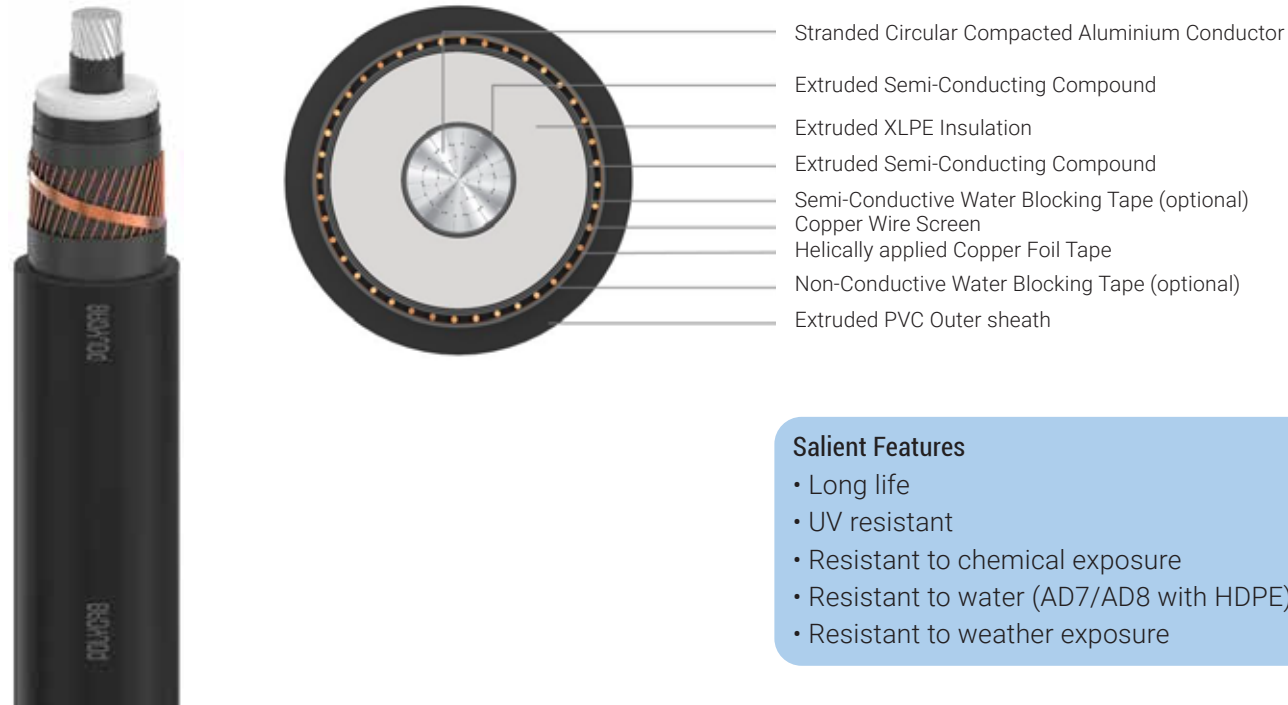

- Salient Features**
- Long life
 - UV resistant
 - Resistant to chemical exposure
 - Resistant to water (AD7/AD8 with HDPE)
 - Resistant to weather exposure

Application
POLYCAB MV 1.9/3.3 KV XLPE insulated with Aluminium conductor single core cable is suitable to use for power supply to wide networks i.e. Commercial, Industrial and Urban / Residential.

Voltage Rating
Nominal Voltage: 1.9/3.3 (3.6) kV

Operation Temperature
Min. installation temperature: 0°C
Operating temperature: -25°C to +90°C
Emergency operating temperature: 105°C
(max. operation of 36hrs, at 3 periods for 12 consecutive months use)
Max. Short Circuit Temperature: 250°C

Construction

- Conductor: Stranded Compacted Circular aluminium conductor as per AS/NZS 1125
- Conductor Screen: Extruded Semi-conductive compound
- Insulation: XLPE
- Insulation Screen: Extruded Semi-conductive compound
- Longitudinal Water blocking : Water blocking tape above and below copper screen (Optional)
- Metallic Insulation Screen: Copper Wire Screen + helicly applied copper tape (E/F current capacity – Based on requirement)
- Metallic Sheath: Lead Alloy (optional)
- Outer Sheath: Extruded Polyvinyl Chloride, Colour: Black
(Alternative Sheath: PVC+HDPE Composite Sheath or LSZH Outer sheath and parameters will change accordingly)

Bending Radius: 20D
Fixed Installation: 12D (PVC) / 15D (HDPE)
During Installation: 18D (PVC) / 25D (HDPE)

D is overall diameter of cable

Standard and References:
AS/NZS 1429.1
AS/NZS 1125
AS/NZS 3808

Impulse Test Voltage
6.5 kV AC

Compliance

- Conductor resistance AS/NZS 1125
- Insulation resistance AS/NZS 1429.1
- Voltage test AS/NZS 1429.1



DIMENSIONAL CHARACTERISTICS:

Product Code	No. of Cores	Core Cross sectional Area	Nominal Diameter		
			Under metallic screen	Over metallic screen	Overall
	No.	mm ²	mm	mm	mm
MVNZ10AXUAPH001C016SAXXXX	1	16	11.8	13.7	18.0
MVNZ10AXUAPH001C025SAXXXX	1	25	13.1	15.0	19.0
MVNZ10AXUAPH001C035SAXXXX	1	35	14.1	16.0	20.0
MVNZ10AXUAPH001C050SAXXXX	1	50	15.2	17.1	21.0
MVNZ10AXUAPH001C070SAXXXX	1	70	16.8	18.7	23.0
MVNZ10AXUAPH001C095SAXXXX	1	95	18.4	20.3	24.0
MVNZ10AXUAPH001C120SAXXXX	1	120	20	21.9	26.0
MVNZ10AXUAPH001C150SAXXXX	1	150	21.3	23.2	27.0
MVNZ10AXUAPH001C185SAXXXX	1	185	23	24.9	29.0
MVNZ10AXUAPH001C240SAXXXX	1	240	25.3	27.2	31.0
MVNZ10AXUAPH001C300SAXXXX	1	300	27.5	29.4	34.0
MVNZ10AXUAPH001C400SAXXXX	1	400	30.2	32.1	37.0
MVNZ10AXUAPH001C500SAXXXX	1	500	34	35.9	41.0
MVNZ10AXUAPH001C630SAXXXX	1	630	37.6	39.5	44.0
MVNZ10AXUAPH001C800SAXXXX	1	800	41.9	43.8	49.0
MVNZ10AXUAPH001C01KSAXXXX	1	1000	46.8	48.7	54.0

• Above mentioned parameters are based on 3kA/sec earth fault current capacity of copper screen



POLYCAB SINGLE CORE MV AS/NZS 1429.1 1.9/3.3 (3.6) KV
MV Cable with Copper Conductor, XLPE Insulation, Copper Screen and Unarmoured

ELECTRICAL CHARACTERISTICS:

No. of Cores	Core Cross sectional Area	Max. DC Resistance at 20°C	Max. AC Resistance at 90°C	Approx. Capacitance	Approx. Inductance	Approx. Reactance	Continuous Current Rating					
							In ground at 20°C		In Duct at 20°C		In air at 30°C	
							Flat	Trefoil	Flat	Trefoil	Flat	Trefoil
No.	mm ²	Ω/km	Ω/km	μF/km	mH/km	Ω/km	Amps					
1	16	1.91	2.449	0.26	0.467	0.147	88	84	81	80	99	97
1	25	1.2	1.539	0.3	0.431	0.135	112	108	103	102	130	127
1	35	0.868	1.113	0.34	0.411	0.129	134	129	123	122	157	154
1	50	0.641	0.822	0.38	0.392	0.123	157	152	146	142	189	184
1	70	0.443	0.568	0.43	0.362	0.114	192	186	178	176	236	230
1	95	0.32	0.411	0.49	0.345	0.108	229	221	213	210	287	280
1	120	0.253	0.325	0.55	0.328	0.103	260	252	242	240	332	324
1	150	0.206	0.265	0.59	0.319	0.100	288	281	271	267	376	368
1	185	0.164	0.211	0.65	0.309	0.097	324	317	307	303	432	424
1	240	0.125	0.162	0.73	0.298	0.094	373	367	356	351	511	502
1	300	0.1	0.130	0.81	0.289	0.091	419	414	402	397	586	577
1	400	0.0778	0.102	0.9	0.280	0.088	466	470	457	451	676	673
1	500	0.0605	0.081	0.93	0.274	0.086	525	530	510	505	760	750
1	630	0.0469	0.064	0.95	0.269	0.084	580	585	560	555	860	850
1	800	0.0367	0.052	0.99	0.264	0.083	650	655	620	615	960	950
1	1000	0.0291	0.043	1.04	0.259	0.081	715	705	670	665	1060	1050

*: Current Ratings are based on IEC 60502-2 & IEC 60287, Max. Conductor Temperature at 90°C, Ambient temperature at 30°C in Air / at 20°C in Ground, Thermal resistivity of Soil 1.5 k.m/W & for earthenware ducts 1.2k.m/W and Depth of Laying 0.8m.

Current rating de-rating factors for other than 30°C ambient air temperature.

20	25	35	40	45	50	55	60
1.08	1.04	0.96	0.91	0.87	0.82	0.76	0.71

Current rating de-rating factors for other than 20°C ground temperature.

10	15	25	30	35	40	45	50
1.07	1.04	0.96	0.93	0.89	0.85	0.80	0.76

POLYCAB SINGLE CORE MV AS/NZS 1429.1 1.9/3.3 (3.6) KV
MV Cable with Copper Conductor, XLPE Insulation, Copper Screen and Unarmoured

No. of Cores	Core Cross sectional Area	Max. pulling tension on conductor	Charging Current per phase	Zero sequence impedance	Electric Stress at Conductor Screen	Short circuit rating of Phase conductor
No.	mm ²	kN	Amps/Km	Ohms/Km	kV/mm	kA, 1 sec
1	16	0.8	0.16	3.61	1.3	1.5
1	25	1.25	0.18	2.70	1.2	2.4
1	35	1.75	0.2	2.27	1.2	3.3
1	50	2.5	0.23	1.98	1.1	4.7
1	70	3.5	0.26	1.73	1.1	6.6
1	95	4.75	0.29	1.57	1.1	9.0
1	120	6	0.33	1.48	1.1	11.3
1	150	7.5	0.35	1.42	1.1	14.2
1	185	9.25	0.39	1.37	1.1	17.4
1	240	12	0.44	1.32	1.0	22.6
1	300	15	0.48	1.29	1.0	28.3
1	400	20	0.54	1.26	1.0	37.6
1	500	25	0.56	1.24	0.9	47.2
1	630	31.5	0.57	1.22	0.9	59.6
1	800	40	0.59	1.21	0.8	75.6
1	1000	50	0.62	1.20	0.7	94.5



OUR CERTIFICATION
 ISO 9001 | ISO 14001 | ISO 45001



OUR CERTIFICATION
 ISO 9001 | ISO 14001 | ISO 45001



POLYCAB SINGLE CORE ANTI-TERMITE MV AS/NZS 1429.1 1.9/3.3 (3.6) KV
MV Cable with Aluminium Conductor, XLPE Insulation, Copper Screen and Unarmoured

POLYCAB SINGLE CORE ANTI-TERMITE MV AS/NZS 1429.1 1.9/3.3 (3.6) KV
MV Cable with Aluminium Conductor, XLPE Insulation, Copper Screen and Unarmoured

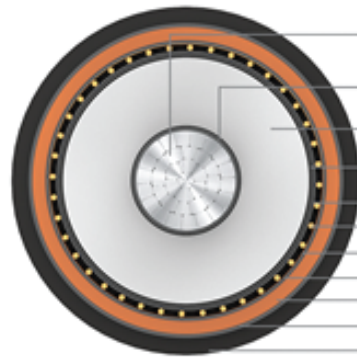

- Stranded Circular Compacted Aluminium Conductor
- Extruded Semi-Conducting Compound
- Extruded XLPE Insulation
- Extruded Semi-Conducting Compound
- Semi-Conductive Water Blocking Tape (optional)
- Copper Wire Screen
- Helically applied Copper Foil Tape
- Non-Conductive Water Blocking Tape (optional)
- Extruded PVC Inner layer
- Polyamide (Nylon-12) Anti-Termite layer
- Extruded HDPE outer sheath

Salient Features

- Long life
- UV resistant
- Resistant to chemical exposure
- Resistant to weather exposure
- Resistant to water (AD7/AD8)
- Termite resistant

Application
POLYCAB MV 1.9/3.3 KV XLPE insulated with Aluminium conductor single core cable is suitable to use for power supply to wide networks i.e. Commercial, Industrial and Urban / Residential.

Voltage Rating
Nominal Voltage: 1.9/3.3 (3.6) kV

Bending Radius: 20D
Fixed Installation: 20D
During Installation: 30D

Operation Temperature
Min. installation temperature: 0°C
Operating temperature: -25°C to +90°C
Emergency operating temperature: 105°C
(max. operation of 36hrs, at 3 periods for 12 consecutive months use)
Max. Short Circuit Temperature: 250°C

D is overall diameter of cable

Standard and References:
AS/NZS 1429.1
AS/NZS 1125
AS/NZS 3808

- Construction**
- Conductor: Stranded Compacted Circular aluminium conductor as per AS/NZS 1125
 - Conductor Screen: Extruded Semi-conductive compound
 - Insulation: XLPE
 - Insulation Screen: Extruded Semi-conductive compound
 - Longitudinal Water blocking : Water blocking tape above and below copper screen (Optional)
 - Metallic Insulation Screen: Copper Wire Screen + helically applied copper tape (E/F current capacity – Based on requirement)
- Composite sheath**
- Inner layer : Extruded Polyvinyl Chloride, Colour: Orange
 - Termite Protection: Polyamide (Nylon -12)
 - Outer layer: HDPE (Black)

Impulse Test Voltage
6.5 kV AC

- Compliance**
- Conductor resistance AS/NZS 1125
 - Insulation resistance AS/NZS 1429.1
 - Voltage test AS/NZS 1429.1



DIMENSIONAL CHARACTERISTICS:

Product Code	No. of Cores	Core Cross sectional Area	Nominal Diameter		
			Under metallic screen	Over metallic screen	Overall
	No.	mm ²	mm	mm	mm
MVNZ10AXUAPH001C016SAXXXX	1	16	11.8	13.7	18.0
MVNZ10AXUAPH001C025SAXXXX	1	25	13.1	15.0	21.0
MVNZ10AXUAPH001C035SAXXXX	1	35	14.1	16.0	22.0
MVNZ10AXUAPH001C050SAXXXX	1	50	15.2	17.1	23.0
MVNZ10AXUAPH001C070SAXXXX	1	70	16.8	18.7	25.0
MVNZ10AXUAPH001C095SAXXXX	1	95	18.4	20.3	26.0
MVNZ10AXUAPH001C120SAXXXX	1	120	20	21.9	28.0
MVNZ10AXUAPH001C150SAXXXX	1	150	21.3	23.2	29.0
MVNZ10AXUAPH001C185SAXXXX	1	185	23	24.9	31.0
MVNZ10AXUAPH001C240SAXXXX	1	240	25.3	27.2	33.0
MVNZ10AXUAPH001C300SAXXXX	1	300	27.5	29.4	36.0
MVNZ10AXUAPH001C400SAXXXX	1	400	30.2	32.1	39.0
MVNZ10AXUAPH001C500SAXXXX	1	500	34	35.9	43.0
MVNZ10AXUAPH001C630SAXXXX	1	630	37.6	39.5	47.0
MVNZ10AXUAPH001C800SAXXXX	1	800	41.9	43.8	51.0
MVNZ10AXUAPH001C01KSAXXXX	1	1000	46.8	48.7	57.0

• Above mentioned parameters are based on 3kA/sec earth fault current capacity of copper screen



POLYCAB SINGLE CORE ANTI-TERMITE MV AS/NZS 1429.1 1.9/3.3 (3.6) KV
MV Cable with Aluminium Conductor, XLPE Insulation, Copper Screen and Unarmoured

ELECTRICAL CHARACTERISTICS:

No. of Cores	Core Cross sectional Area	Max. DC Resistance at 20°C	Max. AC Resistance at 90°C	Approx. Capacitance	Approx. Inductance	Approx. Reactance	Continuous Current Rating					
							In ground at 20°C		In Duct at 20°C		In air at 30°C	
							Flat	Trefoil	Flat	Trefoil	Flat	Trefoil
No.	mm ²	Ω/km	Ω/km	μF/km	mH/km	Ω/km	Amps					
1	16	1.91	2.449	0.26	0.475	0.149	88	84	81	80	99	97
1	25	1.2	1.539	0.3	0.454	0.143	112	108	103	102	130	127
1	35	0.868	1.113	0.34	0.432	0.136	134	129	123	122	157	154
1	50	0.641	0.822	0.38	0.412	0.129	157	152	146	142	189	184
1	70	0.443	0.568	0.43	0.380	0.119	192	186	178	176	236	230
1	95	0.32	0.411	0.49	0.362	0.114	229	221	213	210	287	280
1	120	0.253	0.325	0.55	0.345	0.108	260	252	242	240	332	324
1	150	0.206	0.265	0.59	0.335	0.105	288	281	271	267	376	368
1	185	0.164	0.211	0.65	0.323	0.102	324	317	307	303	432	424
1	240	0.125	0.161	0.73	0.311	0.098	373	367	356	351	511	502
1	300	0.1	0.130	0.81	0.299	0.094	419	414	402	397	586	577
1	400	0.0778	0.102	0.9	0.291	0.091	466	470	457	451	676	673
1	500	0.0605	0.080	0.93	0.284	0.089	525	530	510	505	760	750
1	630	0.0469	0.064	0.95	0.278	0.087	580	585	560	555	860	850
1	800	0.0367	0.052	0.99	0.273	0.086	650	655	620	615	960	950
1	1000	0.0291	0.043	1.04	0.268	0.084	715	705	670	665	1060	1050

*: Current Ratings are based on IEC 60502-2 & IEC 60287, Max. Conductor Temperature at 90°C, Ambient temperature at 30°C in Air / at 20°C in Ground, Thermal resistivity of Soil 1.5 k.m/W & for earthenware ducts 1.2k.m/W and Depth of Laying 0.8m.

Current rating de-rating factors for other than 30°C ambient air temperature.

20	25	35	40	45	50	55	60
1.08	1.04	0.96	0.91	0.87	0.82	0.76	0.71

Current rating de-rating factors for other than 20°C ground temperature.

10	15	25	30	35	40	45	50
1.07	1.04	0.96	0.93	0.89	0.85	0.80	0.76

POLYCAB SINGLE CORE ANTI-TERMITE MV AS/NZS 1429.1 1.9/3.3 (3.6) KV
MV Cable with Aluminium Conductor, XLPE Insulation, Copper Screen and Unarmoured

No. of Cores	Core Cross sectional Area	Max. pulling tension on conductor	Charging Current per phase	Zero sequence impedance	Electric Stress at Conductor Screen	Short circuit rating of Phase conductor
No.	mm ²	kN	Amps/Km	Ohms/Km	kV/mm	kA, 1 sec
1	16	0.8	0.16	3.61	1.3	1.5
1	25	1.25	0.18	2.70	1.2	2.4
1	35	1.75	0.2	2.27	1.2	3.3
1	50	2.5	0.23	1.98	1.1	4.7
1	70	3.5	0.26	1.73	1.1	6.6
1	95	4.75	0.29	1.57	1.1	9.0
1	120	6	0.33	1.48	1.1	11.3
1	150	7.5	0.35	1.42	1.1	14.2
1	185	9.25	0.39	1.37	1.1	17.4
1	240	12	0.44	1.32	1.0	22.6
1	300	15	0.48	1.29	1.0	28.3
1	400	20	0.54	1.26	1.0	37.6
1	500	25	0.56	1.24	0.9	47.2
1	630	31.5	0.57	1.22	0.9	59.6
1	800	40	0.59	1.21	0.8	75.6
1	1000	50	0.62	1.20	0.7	94.5



OUR CERTIFICATION
 ISO 9001 | ISO 14001 | ISO 45001



OUR CERTIFICATION
 ISO 9001 | ISO 14001 | ISO 45001



POLYCAB SINGLE CORE MV AS/NZS 1429.1 3.8/6.6 (7.2) KV
MV Cable with Copper Conductor, XLPE Insulation, Copper Screen and Unarmoured

POLYCAB SINGLE CORE MV AS/NZS 1429.1 3.8/6.6 (7.2) KV
MV Cable with Copper Conductor, XLPE Insulation, Copper Screen and Unarmoured

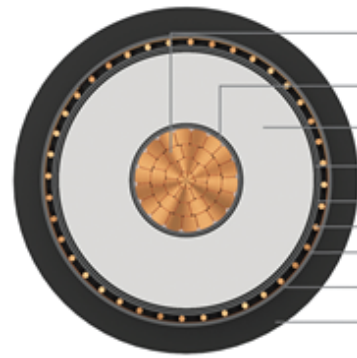

- Stranded Circular Compacted Copper Conductor
- Extruded Semi-Conducting Compound
- Extruded XLPE Insulation
- Extruded Strippable Semi-Conducting Compound
- Semi-Conductive Water Blocking Tape (optional)
- Copper Wire Screen
- Helicly applied Copper Foil Tape
- Non-Conductive Water Blocking Tape (optional)
- Extruded PVC Outer sheath

Salient Features

- Long life
- UV resistant
- Resistant to chemical exposure
- Resistant to water (AD7/AD8 with HDPE)
- Resistant to weather exposure
- Termite resistant (Optional)

Application
POLYCAB MV 3.8/6.6 KV XLPE insulated with Copper conductor single core cable is suitable to use for power supply to wide networks i.e. Commercial, Industrial and Urban / Residential.

Voltage Rating
Nominal Voltage: 3.8/6.6 (7.2) kV

Operation Temperature
Min. installation temperature: 0°C
Operating temperature: -25°C to +90°C
Emergency operating temperature: 105°C
(max. operation of 36hrs, at 3 periods for 12 consecutive months use)
Max. Short Circuit Temperature: 250°C

- Construction**
- Conductor: Stranded Compacted Circular Copper conductor as per AS/NZS 1125
 - Conductor Screen: Extruded Semi-conductive compound
 - Insulation: XLPE
 - Insulation Screen: Extruded Strippable Semi-conductive compound
 - Longitudinal Water blocking : Water blocking tape above and below copper screen (Optional)
 - Metallic Insulation Screen: Copper Wire Screen + helicly applied copper tape (E/F current capacity – Based on requirement)
 - Metallic Sheath: Lead Alloy (optional)
 - Outer Sheath: Extruded Polyvinyl Chloride, Colour: Black
 - Termite Protection: Polyamide (Nylon -12) (optional)
(Alternative Sheath: PVC+HDPE Composite Sheath or PVC + Nylon + HDPE (composite sheath with anti-termite properties) or LSZH Outer sheath, and parameters will change accordingly)

Bending Radius: 20D
Fixed Installation: 12D (PVC) / 15D (HDPE) / 20D (Nylon)
During Installation: 18D (PVC) / 25D (HDPE) / 30D (Nylon)

D is overall diameter of cable

Standard and References:
AS/NZS 1429.1
AS/NZS 1125
AS/NZS 3808

High Voltage Test (kV AC)	Partial discharge test (kV AC)		Impulse test Voltage (kV peak)
	200% to rated voltage	150% to rated voltage	
12.5	7.6	5.7	60

- Compliance**
- Conductor resistance AS/NZS 1125
 - Insulation resistance AS/NZS 1429.1
 - Voltage test AS/NZS 1429.1



DIMENSIONAL CHARACTERISTICS:

Product Code	No. of Cores	Core Cross sectional Area	Nominal Diameter		
			Under metallic screen	Over metallic screen	Overall
	No.	mm ²	mm	mm	mm
MVNZ15CXUAPH001C016SAXXXX	1	16	12.9	14.8	19.0
MVNZ15CXUAPH001C025SAXXXX	1	25	14.1	16.0	20.0
MVNZ15CXUAPH001C035SAXXXX	1	35	15.1	17.0	21.0
MVNZ15CXUAPH001C050SAXXXX	1	50	16.2	18.1	22.0
MVNZ15CXUAPH001C070SAXXXX	1	70	17.9	19.8	24.0
MVNZ15CXUAPH001C095SAXXXX	1	95	19.4	21.3	25.0
MVNZ15CXUAPH001C120SAXXXX	1	120	21	22.9	27.0
MVNZ15CXUAPH001C150SAXXXX	1	150	22.4	24.3	28.0
MVNZ15CXUAPH001C185SAXXXX	1	185	24.1	26.0	30.0
MVNZ15CXUAPH001C240SAXXXX	1	240	26.6	28.5	33.0
MVNZ15CXUAPH001C300SAXXXX	1	300	29	30.9	35.0
MVNZ15CXUAPH001C400SAXXXX	1	400	32.2	34.1	39.0
MVNZ15CXUAPH001C500SAXXXX	1	500	36	37.9	43.0
MVNZ15CXUAPH001C630SAXXXX	1	630	39.6	41.5	47.0
MVNZ15CXUAPH001C800SAXXXX	1	800	43.3	45.2	50.0
MVNZ15CXUAPH001C01KSAXXXX	1	1000	47.6	49.5	55.0

- Above mentioned parameters are based on 3kA/sec earth fault current capacity of copper screen



POLYCAB SINGLE CORE MV AS/NZS 1429.1 3.8/6.6 (7.2) KV
MV Cable with Copper Conductor, XLPE Insulation, Copper Screen and Unarmoured

ELECTRICAL CHARACTERISTICS:

No. of Cores	Core Cross sectional Area	Max. DC Resistance at 20°C	Max. AC Resistance at 90°C	Approx. Capacitance	Approx. Inductance	Approx. Reactance	Continuous Current Rating					
							In ground at 20°C		In Duct at 20°C		In air at 30°C	
							Flat	Trefoil	Flat	Trefoil	Flat	Trefoil
No.	mm ²	Ω/km	Ω/km	μF/km	mH/km	Ω/km	Amps					
1	16	1.15	1.466	0.22	0.475	0.149	113	109	104	103	128	125
1	25	0.727	0.927	0.25	0.442	0.139	144	140	133	132	167	163
1	35	0.524	0.668	0.28	0.421	0.132	172	166	159	157	203	198
1	50	0.387	0.494	0.31	0.401	0.126	203	196	188	186	243	238
1	70	0.268	0.342	0.36	0.369	0.116	246	239	229	227	303	296
1	95	0.193	0.247	0.4	0.353	0.111	293	285	274	271	369	361
1	120	0.153	0.196	0.45	0.336	0.106	332	323	311	308	426	417
1	150	0.124	0.159	0.49	0.326	0.102	366	361	347	343	481	473
1	185	0.0991	0.128	0.54	0.316	0.099	410	406	391	387	550	543
1	240	0.0754	0.098	0.58	0.305	0.096	470	469	453	447	647	641
1	300	0.0601	0.079	0.59	0.299	0.094	524	526	510	504	739	735
1	400	0.047	0.063	0.62	0.291	0.091	572	590	571	564	837	845
1	500	0.0366	0.051	0.66	0.284	0.089	660	655	640	635	970	960
1	630	0.0283	0.042	0.74	0.276	0.087	735	730	715	710	1110	1100
1	800	0.0221	0.035	0.82	0.269	0.084	770	820	800	790	1260	1250
1	1000	0.0176	0.030	0.91	0.262	0.082	825	885	865	855	1420	1410

*: Current Ratings are based on IEC 60502-2 & IEC 60287, Max. Conductor Temperature at 90°C, Ambient temperature at 30°C in Air / at 20°C in Ground, Thermal resistivity of Soil 1.5 k.m/W & for earthenware ducts 1.2k.m/W and Depth of Laying 0.8m.

Current rating de-rating factors for other than 30°C ambient air temperature.

20	25	35	40	45	50	55	60
1.08	1.04	0.96	0.91	0.87	0.82	0.76	0.71

Current rating de-rating factors for other than 20°C ground temperature.

10	15	25	30	35	40	45	50
1.07	1.04	0.96	0.93	0.89	0.85	0.80	0.76

POLYCAB SINGLE CORE MV AS/NZS 1429.1 3.8/6.6 (7.2) KV
MV Cable with Copper Conductor, XLPE Insulation, Copper Screen and Unarmoured

No. of Cores	Core Cross sectional Area	Max. pulling tension on conductor	Charging Current per phase	Zero sequence impedance	Electric Stress at Conductor Screen	Short circuit rating of Phase conductor
No.	mm ²	kN	Amps/Km	Ohms/Km	kV/mm	kA, 1 sec
1	16	1.12	0.26	2.63	2.1	2.3
1	25	1.75	0.3	2.09	2.0	3.6
1	35	2.45	0.33	1.83	2.0	5.0
1	50	3.5	0.37	1.65	1.9	7.2
1	70	4.9	0.43	1.50	1.9	10.0
1	95	6.65	0.48	1.41	1.8	13.6
1	120	8.4	0.54	1.36	1.8	17.1
1	150	10.5	0.58	1.32	1.8	21.4
1	185	12.95	0.64	1.29	1.7	26.4
1	240	16.8	0.69	1.26	1.7	34.3
1	300	21	0.7	1.24	1.5	42.8
1	400	28	0.74	1.22	1.4	56.9
1	500	35	0.79	1.21	1.3	71.5
1	630	44.1	0.88	1.20	1.3	90.2
1	800	56	0.98	1.19	1.3	114
1	1000	70	1.09	1.19	1.3	143



OUR CERTIFICATION
 ISO 9001 | ISO 14001 | ISO 45001



OUR CERTIFICATION
 ISO 9001 | ISO 14001 | ISO 45001



POLYCAB SINGLE CORE MV AS/NZS 1429.1 3.8/6.6 (7.2) KV
MV Cable with Aluminium Conductor, XLPE Insulation, Copper Screen and Unarmoured

POLYCAB SINGLE CORE MV AS/NZS 1429.1 3.8/6.6 (7.2) KV
MV Cable with Aluminium Conductor, XLPE Insulation, Copper Screen and Unarmoured

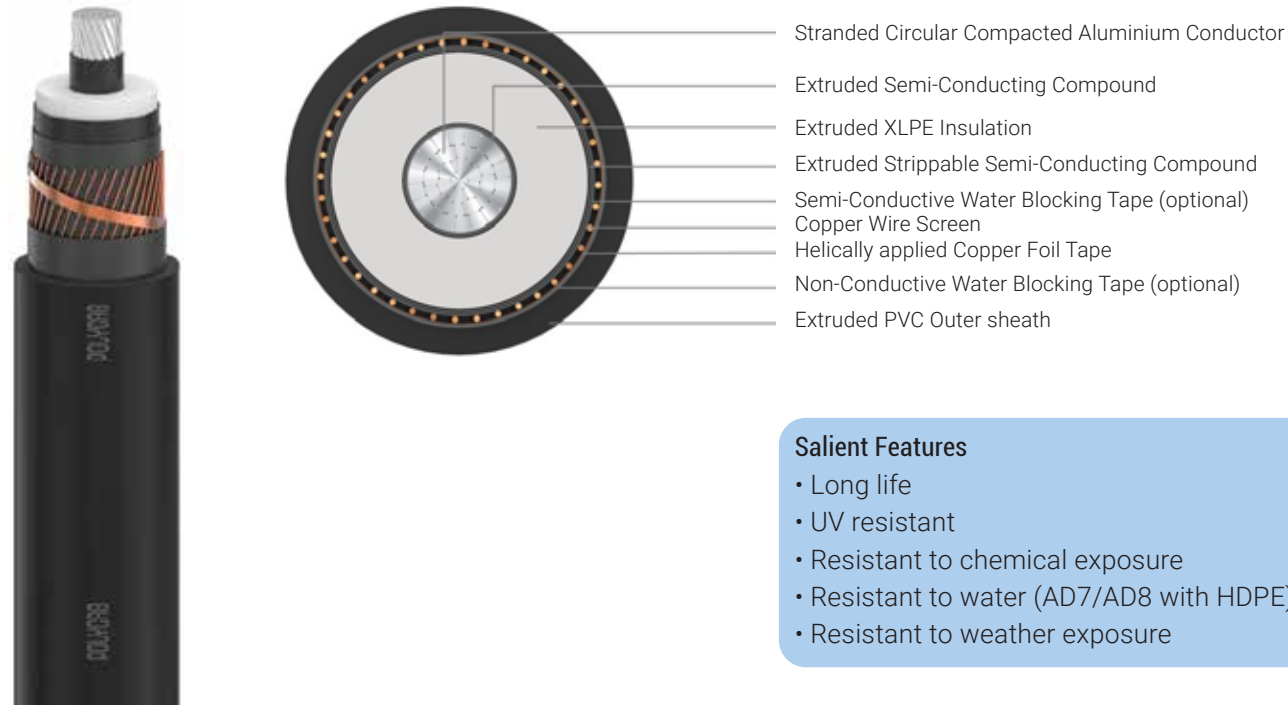

- Salient Features**
- Long life
 - UV resistant
 - Resistant to chemical exposure
 - Resistant to water (AD7/AD8 with HDPE)
 - Resistant to weather exposure

Application
POLYCAB MV 3.8/6.6 KV XLPE insulated with Aluminium conductor single core cable is suitable to use for power supply to wide networks i.e. Commercial, Industrial and Urban / Residential.

Voltage Rating
Nominal Voltage: 3.8/6.6 (7.2) kV

Operation Temperature
Min. installation temperature: 0°C
Operating temperature: -25°C to +90°C
Emergency operating temperature: 105°C
(max. operation of 36hrs, at 3 periods for 12 consecutive months use)
Max. Short Circuit Temperature: 250°C

Construction

- Conductor: Stranded Compacted Circular aluminium conductor as per AS/NZS 1125
- Conductor Screen: Extruded Semi-conductive compound
- Insulation: XLPE
- Insulation Screen: Extruded strippable Semi-conductive compound
- Longitudinal Water blocking : Water blocking tape above and below copper screen (Optional)
- Metallic Insulation Screen: Copper Wire Screen + helicly applied copper tape (E/F current capacity – Based on requirement)
- Metallic Sheath: Lead Alloy (optional)
- Outer Sheath: Extruded Polyvinyl Chloride, Colour: Black
(Alternative Sheath: PVC+HDPE Composite Sheath or LSZH Outer sheath and parameters will change accordingly)

Bending Radius: 20D
Fixed Installation: 12D (PVC) / 15D (HDPE)
During Installation: 18D (PVC) / 25D (HDPE)

D is overall diameter of cable

Standard and References:
AS/NZS 1429.1
AS/NZS 1125
AS/NZS 3808

High Voltage Test (kV AC)	Partial discharge test (kV AC)		Impulse test Voltage (kV peak)
	200% to rated voltage	150% to rated voltage	
12.5	7.6	5.7	60

Compliance

- Conductor resistance AS/NZS 1125
- Insulation resistance AS/NZS 1429.1
- Voltage test AS/NZS 1429.1



DIMENSIONAL CHARACTERISTICS:

Product Code	No. of Cores	Core Cross sectional Area	Nominal Diameter		
			Under metallic screen	Over metallic screen	Overall
	No.	mm ²	mm	mm	mm
MVNZ15AXUAPH001C016SAXXXX	1	16	12.8	14.7	19.0
MVNZ15AXUAPH001C025SAXXXX	1	25	14.1	16.0	20.0
MVNZ15AXUAPH001C035SAXXXX	1	35	15.1	17.0	21.0
MVNZ15AXUAPH001C050SAXXXX	1	50	16.2	18.1	22.0
MVNZ15AXUAPH001C070SAXXXX	1	70	17.8	19.7	24.0
MVNZ15AXUAPH001C095SAXXXX	1	95	19.4	21.3	25.0
MVNZ15AXUAPH001C120SAXXXX	1	120	21	22.9	27.0
MVNZ15AXUAPH001C150SAXXXX	1	150	22.3	24.2	28.0
MVNZ15AXUAPH001C185SAXXXX	1	185	24	25.9	30.0
MVNZ15AXUAPH001C240SAXXXX	1	240	26.5	28.4	33.0
MVNZ15AXUAPH001C300SAXXXX	1	300	29.1	31.0	35.0
MVNZ15AXUAPH001C400SAXXXX	1	400	32.2	34.1	39.0
MVNZ15AXUAPH001C500SAXXXX	1	500	36	37.9	43.0
MVNZ15AXUAPH001C630SAXXXX	1	630	39.2	41.1	46.0
MVNZ15AXUAPH001C800SAXXXX	1	800	43.1	45.0	50.0
MVNZ15AXUAPH001C01KSAXXXX	1	1000	47.6	49.5	55.0

• Above mentioned parameters are based on 3kA/sec earth fault current capacity of copper screen



POLYCAB SINGLE CORE MV AS/NZS 1429.1 3.8/6.6 (7.2) KV
MV Cable with Aluminium Conductor, XLPE Insulation, Copper Screen and Unarmoured

ELECTRICAL CHARACTERISTICS:

No. of Cores	Core Cross sectional Area	Max. DC Resistance at 20°C	Max. AC Resistance at 90°C	Approx. Capacitance	Approx. Inductance	Approx. Reactance	Continuous Current Rating					
							In ground at 20°C		In Duct at 20°C		In air at 30°C	
							Flat	Trefoil	Flat	Trefoil	Flat	Trefoil
No.	mm ²	Ω/km	Ω/km	μF/km	mH/km	Ω/km	Amps					
1	16	1.91	2.449	0.22	0.478	0.150	88	84	81	80	99	97
1	25	1.2	1.539	0.25	0.442	0.139	112	108	103	102	130	127
1	35	0.868	1.113	0.28	0.421	0.132	134	129	123	122	157	154
1	50	0.641	0.822	0.31	0.401	0.126	157	152	146	142	189	184
1	70	0.443	0.568	0.36	0.370	0.116	192	186	178	176	236	230
1	95	0.32	0.411	0.4	0.353	0.111	229	221	213	210	287	280
1	120	0.253	0.325	0.45	0.336	0.106	260	252	242	240	332	324
1	150	0.206	0.265	0.49	0.326	0.103	288	281	271	267	376	368
1	185	0.164	0.211	0.53	0.317	0.100	324	317	307	303	432	424
1	240	0.125	0.161	0.58	0.306	0.096	373	367	356	351	511	502
1	300	0.1	0.130	0.6	0.298	0.094	419	414	402	397	586	577
1	400	0.0778	0.102	0.62	0.291	0.091	466	470	457	451	676	673
1	500	0.0605	0.080	0.66	0.284	0.089	525	530	510	505	760	750
1	630	0.0469	0.064	0.73	0.277	0.087	580	585	560	555	860	850
1	800	0.0367	0.052	0.82	0.269	0.085	650	655	620	615	960	950
1	1000	0.0291	0.043	0.91	0.262	0.082	715	705	670	665	1060	1050

*: Current Ratings are based on IEC 60502-2 & IEC 60287, Max. Conductor Temperature at 90°C, Ambient temperature at 30°C in Air / at 20°C in Ground, Thermal resistivity of Soil 1.5 k.m/W & for earthenware ducts 1.2k.m/W and Depth of Laying 0.8m.

Current rating de-rating factors for other than 30°C ambient air temperature.

20	25	35	40	45	50	55	60
1.08	1.04	0.96	0.91	0.87	0.82	0.76	0.71

Current rating de-rating factors for other than 20°C ground temperature.

10	15	25	30	35	40	45	50
1.07	1.04	0.96	0.93	0.89	0.85	0.80	0.76

POLYCAB SINGLE CORE MV AS/NZS 1429.1 1.9/3.3 (3.6) KV
MV Cable with Copper Conductor, XLPE Insulation, Copper Screen and Unarmoured

No. of Cores	Core Cross sectional Area	Max. pulling tension on conductor	Charging Current per phase	Zero sequence impedance	Electric Stress at Conductor Screen	Short circuit rating of Phase conductor
No.	mm ²	kN	Amps/Km	Ohms/Km	kV/mm	kA, 1 sec
1	16	0.8	0.26	3.61	2.1	1.5
1	25	1.25	0.3	2.70	2.0	2.4
1	35	1.75	0.33	2.27	2.0	3.3
1	50	2.5	0.37	1.98	1.9	4.7
1	70	3.5	0.43	1.73	1.9	6.6
1	95	4.75	0.48	1.57	1.8	9.0
1	120	6	0.54	1.48	1.8	11.3
1	150	7.5	0.58	1.42	1.8	14.2
1	185	9.25	0.63	1.37	1.7	17.4
1	240	12	0.69	1.32	1.7	22.6
1	300	15	0.72	1.29	1.5	28.3
1	400	20	0.74	1.26	1.4	37.6
1	500	25	0.79	1.24	1.3	47.2
1	630	31.5	0.87	1.22	1.3	59.6
1	800	40	0.98	1.21	1.3	75.6
1	1000	50	1.09	1.20	1.3	94.5



OUR CERTIFICATION
 ISO 9001 | ISO 14001 | ISO 45001



OUR CERTIFICATION
 ISO 9001 | ISO 14001 | ISO 45001



POLYCAB SINGLE CORE ANTI-TERMITE MV AS/NZS 1429.1 3.8/6.6 (7.2) KV
MV Cable with Aluminium Conductor, XLPE Insulation, Copper Screen and Unarmoured

POLYCAB SINGLE CORE ANTI-TERMITE MV AS/NZS 1429.1 3.8/6.6 (7.2) KV
MV Cable with Aluminium Conductor, XLPE Insulation, Copper Screen and Unarmoured

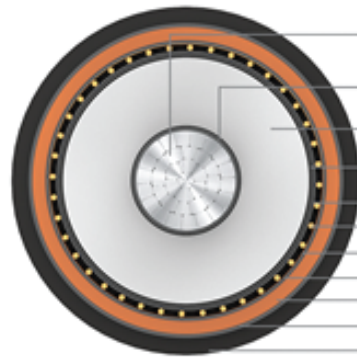

- Stranded Circular Compacted Aluminium Conductor
- Extruded Semi-Conducting Compound
- Extruded XLPE Insulation
- Extruded Strippable Semi-Conducting Compound
- Semi-Conductive Water Blocking Tape (optional)
- Copper Wire Screen
- Helically applied Copper Foil Tape
- Non-Conductive Water Blocking Tape (optional)
- Extruded PVC Inner layer
- Polyamide (Nylon-12) Anti-Termite layer
- Extruded HDPE outer sheath

Salient Features

- Long life
- UV resistant
- Resistant to chemical exposure
- Resistant to weather exposure
- Resistant to water (AD7/AD8)
- Termite resistant

Application
POLYCAB MV 3.8/6.6 KV XLPE insulated with Aluminium conductor single core cable is suitable to use for power supply to wide networks i.e. Commercial, Industrial and Urban / Residential.

Voltage Rating
Nominal Voltage: 3.8/6.6 (7.2) kV

Bending Radius: 20D
Fixed Installation: 20D
During Installation: 30D

Operation Temperature
Min. installation temperature: 0°C
Operating temperature: -25°C to +90°C
Emergency operating temperature: 105°C
(max. operation of 36hrs, at 3 periods for 12 consecutive months use)
Max. Short Circuit Temperature: 250°C

D is overall diameter of cable

- Construction**
- Conductor: Stranded Compacted Circular aluminium conductor as per AS/NZS 1125
 - Conductor Screen: Extruded Semi-conductive compound
 - Insulation: XLPE
 - Insulation Screen: Extruded strippable Semi-conductive compound
 - Longitudinal Water blocking : Water blocking tape above and below copper screen (Optional)
 - Metallic Insulation Screen: Copper Wire Screen + helically applied copper tape (E/F current capacity – Based on requirement)
- Composite sheath**
- Inner layer : Extruded Polyvinyl Chloride, Colour: Orange
 - Termite Protection: Polyamide (Nylon -12)
 - Outer layer: HDPE (Black)

Standard and References:
AS/NZS 1429.1
AS/NZS 1125
AS/NZS 3808

High Voltage Test (kV AC)	Partial discharge test (kV AC)		Impulse test Voltage (kV peak)
	200% to rated voltage	150% to rated voltage	
12.5	7.6	5.7	60

- Compliance**
- Conductor resistance AS/NZS 1125
 - Insulation resistance AS/NZS 1429.1
 - Voltage test AS/NZS 1429.1



DIMENSIONAL CHARACTERISTICS:

Product Code	No. of Cores	Core Cross sectional Area	Nominal Diameter		
			Under metallic screen	Over metallic screen	Overall
	No.	mm ²	mm	mm	mm
MVNZ15AXUAPH001C016SAXXXX	1	16	12.8	14.7	19.0
MVNZ15AXUAPH001C025SAXXXX	1	25	14.1	16.0	22.0
MVNZ15AXUAPH001C035SAXXXX	1	35	15.1	17.0	23.0
MVNZ15AXUAPH001C050SAXXXX	1	50	16.2	18.1	24.0
MVNZ15AXUAPH001C070SAXXXX	1	70	17.8	19.7	26.0
MVNZ15AXUAPH001C095SAXXXX	1	95	19.4	21.3	27.0
MVNZ15AXUAPH001C120SAXXXX	1	120	21	22.9	29.0
MVNZ15AXUAPH001C150SAXXXX	1	150	22.3	24.2	30.0
MVNZ15AXUAPH001C185SAXXXX	1	185	24	25.9	32.0
MVNZ15AXUAPH001C240SAXXXX	1	240	26.5	28.4	35.0
MVNZ15AXUAPH001C300SAXXXX	1	300	29.1	31.0	37.0
MVNZ15AXUAPH001C400SAXXXX	1	400	32.2	34.1	41.0
MVNZ15AXUAPH001C500SAXXXX	1	500	36	37.9	45.0
MVNZ15AXUAPH001C630SAXXXX	1	630	39.2	41.1	48.0
MVNZ15AXUAPH001C800SAXXXX	1	800	43.1	45.0	53.0
MVNZ15AXUAPH001C01KSAXXXX	1	1000	47.6	49.5	57.0

- Above mentioned parameters are based on 3kA/sec earth fault current capacity of copper screen



POLYCAB SINGLE CORE ANTI-TERMITE MV AS/NZS 1429.1 3.8/6.6 (7.2) KV
MV Cable with Aluminium Conductor, XLPE Insulation, Copper Screen and Unarmoured

ELECTRICAL CHARACTERISTICS:

No. of Cores	Core Cross sectional Area	Max. DC Resistance at 20°C	Max. AC Resistance at 90°C	Approx. Capacitance	Approx. Inductance	Approx. Reactance	Continuous Current Rating					
							In ground at 20°C		In Duct at 20°C		In air at 30°C	
							Flat	Trefoil	Flat	Trefoil	Flat	Trefoil
No.	mm ²	Ω/km	Ω/km	μF/km	mH/km	Ω/km	Amps					
1	16	1.91	2.449	0.22	0.485	0.153	88	84	81	80	99	97
1	25	1.2	1.539	0.25	0.463	0.145	112	108	103	102	130	127
1	35	0.868	1.113	0.28	0.441	0.138	134	129	123	122	157	154
1	50	0.641	0.822	0.31	0.421	0.132	157	152	146	142	189	184
1	70	0.443	0.568	0.36	0.388	0.122	192	186	178	176	236	230
1	95	0.32	0.411	0.4	0.370	0.116	229	221	213	210	287	280
1	120	0.253	0.325	0.45	0.352	0.111	260	252	242	240	332	324
1	150	0.206	0.265	0.49	0.342	0.107	288	281	271	267	376	368
1	185	0.164	0.211	0.53	0.330	0.104	324	317	307	303	432	424
1	240	0.125	0.161	0.58	0.318	0.100	373	367	356	351	511	502
1	300	0.1	0.130	0.6	0.308	0.097	419	414	402	397	586	577
1	400	0.0778	0.102	0.62	0.301	0.095	466	470	457	451	676	673
1	500	0.0605	0.080	0.66	0.294	0.092	525	530	510	505	760	750
1	630	0.0469	0.064	0.73	0.287	0.090	580	585	560	555	860	850
1	800	0.0367	0.052	0.82	0.279	0.088	650	655	620	615	960	950
1	1000	0.0291	0.043	0.91	0.271	0.085	715	705	670	665	1060	1050

*: Current Ratings are based on IEC 60502-2 & IEC 60287, Max. Conductor Temperature at 90°C, Ambient temperature at 30°C in Air / at 20°C in Ground, Thermal resistivity of Soil 1.5 k.m/W & for earthenware ducts 1.2k.m/W and Depth of Laying 0.8m.

Current rating de-rating factors for other than 30°C ambient air temperature.

20	25	35	40	45	50	55	60
1.08	1.04	0.96	0.91	0.87	0.82	0.76	0.71

Current rating de-rating factors for other than 20°C ground temperature.

10	15	25	30	35	40	45	50
1.07	1.04	0.96	0.93	0.89	0.85	0.80	0.76

POLYCAB SINGLE CORE ANTI-TERMITE MV AS/NZS 1429.1 3.8/6.6 (7.2) KV
MV Cable with Aluminium Conductor, XLPE Insulation, Copper Screen and Unarmoured

No. of Cores	Core Cross sectional Area	Max. pulling tension on conductor	Charging Current per phase	Zero sequence impedance	Electric Stress at Conductor Screen	Short circuit rating of Phase conductor
No.	mm ²	kN	Amps/Km	Ohms/Km	kV/mm	kA, 1 sec
1	16	0.8	0.13	3.61	1.1	1.5
1	25	1.25	0.15	2.70	1.0	2.4
1	35	1.75	0.17	2.27	1.0	3.3
1	50	2.5	0.19	1.98	1.0	4.7
1	70	3.5	0.21	1.73	0.9	6.6
1	95	4.75	0.24	1.57	0.9	9.0
1	120	6	0.27	1.48	0.9	11.3
1	150	7.5	0.29	1.42	0.9	14.2
1	185	9.25	0.32	1.37	0.9	17.4
1	240	12	0.35	1.32	0.8	22.6
1	300	15	0.36	1.29	0.8	28.3
1	400	20	0.37	1.26	0.7	37.6
1	500	25	0.39	1.24	0.7	47.2
1	630	31.5	0.44	1.22	0.7	59.6
1	800	40	0.49	1.21	0.6	75.6
1	1000	50	0.54	1.20	0.6	94.5



OUR CERTIFICATION
ISO 9001 | ISO 14001 | ISO 45001



OUR CERTIFICATION
ISO 9001 | ISO 14001 | ISO 45001



POLYCAB SINGLE CORE MV AS/NZS 1429.1 6.35/11 (12) KV
MV Cable with Copper Conductor, XLPE Insulation, Copper Screen and Unarmoured

POLYCAB SINGLE CORE MV AS/NZS 1429.1 6.35/11 (12) KV
MV Cable with Copper Conductor, XLPE Insulation, Copper Screen and Unarmoured

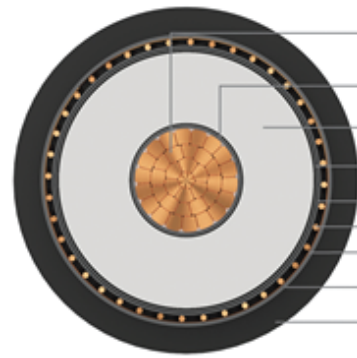

- Stranded Circular Compacted Copper Conductor
- Extruded Semi-Conducting Compound
- Extruded XLPE Insulation
- Extruded Strippable Semi-Conducting Compound
- Semi-Conductive Water Blocking Tape (optional)
- Copper Wire Screen
- Helicly applied Copper Foil Tape
- Non-Conductive Water Blocking Tape (optional)
- Extruded PVC Outer Sheath

Salient Features

- Long life
- UV resistant
- Resistant to chemical exposure
- Resistant to water (AD7/AD8 with HDPE)
- Resistant to weather exposure
- Termite resistant (Optional)

Application
POLYCAB MV 6.35/11 KV XLPE insulated with Copper conductor single core cable is suitable to use for power supply to wide networks i.e. Commercial, Industrial and Urban / Residential.

Voltage Rating
Nominal Voltage: 6.35/11 (12) kV

Operation Temperature
Min. installation temperature: 0°C
Operating temperature: -25°C to +90°C
Emergency operating temperature: 105°C
(max. operation of 36hrs, at 3 periods for 12 consecutive months use)
Max. Short Circuit Temperature: 250°C

- Construction**
- Conductor: Stranded Compacted Circular Copper conductor as per AS/NZS 1125
 - Conductor Screen: Extruded Semi-conductive compound
 - Insulation: XLPE
 - Insulation Screen: Extruded Strippable Semi-conductive compound
 - Longitudinal Water blocking : Water blocking tape above and below copper screen (Optional)
 - Metallic Insulation Screen: Copper Wire Screen + helicly applied copper tape (E/F current capacity – Based on requirement)
 - Metallic Sheath: Lead Alloy (optional)
 - Termite Protection: Polyamide (Nylon -12) (optional)
(Alternative Sheath: PVC+HDPE Composite Sheath or PVC + Nylon + HDPE (composite sheath with anti-termite properties) or LSZH Outer sheath, and parameters will change accordingly)

Bending Radius: 20D
Fixed Installation: 12D (PVC) / 15D (HDPE) / 20D (Nylon)
During Installation: 18D (PVC) / 25D (HDPE) / 30D (Nylon)

D is overall diameter of cable

Standard and References:
AS/NZS 1429.1
AS/NZS 1125
AS/NZS 3808

High Voltage Test (kV AC)	Partial discharge test (kV AC)		Impulse test Voltage (kV peak)
	200% to rated voltage	150% to rated voltage	
21	13	10	95

- Compliance**
- Conductor resistance AS/NZS 1125
 - Insulation resistance AS/NZS 1429.1
 - Voltage test AS/NZS 1429.1



DIMENSIONAL CHARACTERISTICS:

Product Code	No. of Cores	Core Cross sectional Area	Nominal Diameter		
			Under metallic screen	Over metallic screen	Overall
	No.	mm ²	mm	mm	mm
MVNZ17CXUAPH001C016SAXXXX	1	16	14.7	16.6	21.0
MVNZ17CXUAPH001C025SAXXXX	1	25	15.9	17.8	22.0
MVNZ17CXUAPH001C035SAXXXX	1	35	16.9	18.8	23.0
MVNZ17CXUAPH001C050SAXXXX	1	50	18	19.9	24.0
MVNZ17CXUAPH001C070SAXXXX	1	70	19.7	21.6	26.0
MVNZ17CXUAPH001C095SAXXXX	1	95	21.2	23.1	27.0
MVNZ17CXUAPH001C120SAXXXX	1	120	22.8	24.7	29.0
MVNZ17CXUAPH001C150SAXXXX	1	150	24.2	26.1	30.0
MVNZ17CXUAPH001C185SAXXXX	1	185	25.9	27.8	32.0
MVNZ17CXUAPH001C240SAXXXX	1	240	28.2	30.1	34.0
MVNZ17CXUAPH001C300SAXXXX	1	300	30.2	32.1	37.0
MVNZ17CXUAPH001C400SAXXXX	1	400	33	34.9	40.0
MVNZ17CXUAPH001C500SAXXXX	1	500	36.4	38.3	43.0
MVNZ17CXUAPH001C630SAXXXX	1	630	40	41.9	47.0
MVNZ17CXUAPH001C800SAXXXX	1	800	43.7	45.6	51.0
MVNZ17CXUAPH001C01KSAXXXX	1	1000	48	49.9	55.0

- Above mentioned parameters are based on 3kA/sec earth fault current capacity of copper screen



POLYCAB SINGLE CORE MV AS/NZS 1429.1 6.35/11 (12) KV
MV Cable with Copper Conductor, XLPE Insulation, Copper Screen and Unarmoured

ELECTRICAL CHARACTERISTICS:

No. of Cores	Core Cross sectional Area	Max. DC Resistance at 20°C	Max. AC Resistance at 90°C	Approx. Capacitance	Approx. Inductance	Approx. Reactance	Continuous Current Rating					
							In ground at 20°C		In Duct at 20°C		In air at 30°C	
							Flat	Trefoil	Flat	Trefoil	Flat	Trefoil
No.	mm ²	Ω/km	Ω/km	μF/km	mH/km	Ω/km	Amps					
1	16	1.15	1.466	0.18	0.493	0.155	113	109	104	103	128	125
1	25	0.727	0.927	0.2	0.460	0.144	144	140	133	132	167	163
1	35	0.524	0.668	0.22	0.437	0.137	172	166	159	157	203	198
1	50	0.387	0.494	0.25	0.417	0.131	203	196	188	186	243	238
1	70	0.268	0.342	0.28	0.384	0.121	246	239	229	227	303	296
1	95	0.193	0.247	0.31	0.367	0.115	293	285	274	271	369	361
1	120	0.153	0.196	0.35	0.349	0.110	332	323	311	308	426	417
1	150	0.124	0.159	0.38	0.340	0.107	366	361	347	343	481	473
1	185	0.0991	0.128	0.41	0.328	0.103	410	406	391	387	550	543
1	240	0.0754	0.098	0.46	0.316	0.099	470	469	453	447	647	641
1	300	0.0601	0.079	0.5	0.306	0.096	524	526	510	504	739	735
1	400	0.047	0.063	0.56	0.296	0.093	572	590	571	564	837	845
1	500	0.0366	0.051	0.63	0.286	0.090	660	655	640	635	970	960
1	630	0.0283	0.042	0.7	0.278	0.087	735	730	715	710	1110	1100
1	800	0.0221	0.035	0.78	0.270	0.085	770	820	800	790	1260	1250
1	1000	0.0176	0.030	0.86	0.263	0.083	825	885	865	855	1420	1410

*: Current Ratings are based on IEC 60502-2 & IEC 60287, Max. Conductor Temperature at 90°C, Ambient temperature at 30°C in Air / at 20°C in Ground, Thermal resistivity of Soil 1.5 k.m/W & for earthenware ducts 1.2k.m/W and Depth of Laying 0.8m.

Current rating de-rating factors for other than 30°C ambient air temperature.

20	25	35	40	45	50	55	60
1.08	1.04	0.96	0.91	0.87	0.82	0.76	0.71

Current rating de-rating factors for other than 20°C ground temperature.

10	15	25	30	35	40	45	50
1.07	1.04	0.96	0.93	0.89	0.85	0.80	0.76

POLYCAB SINGLE CORE MV AS/NZS 1429.1 6.35/11 (12) KV
MV Cable with Copper Conductor, XLPE Insulation, Copper Screen and Unarmoured

No. of Cores	Core Cross sectional Area	Max. pulling tension on conductor	Charging Current per phase	Zero sequence impedance	Electric Stress at Conductor Screen	Short circuit rating of Phase conductor
No.	mm ²	kN	Amps/Km	Ohms/Km	kV/mm	kA, 1 sec
1	16	1.12	0.36	2.63	2.8	2.3
1	25	1.75	0.4	2.09	2.7	3.6
1	35	2.45	0.44	1.83	2.6	5.0
1	50	3.5	0.5	1.65	2.5	7.2
1	70	4.9	0.56	1.50	2.4	10.0
1	95	6.65	0.62	1.41	2.3	13.6
1	120	8.4	0.7	1.36	2.3	17.1
1	150	10.5	0.76	1.32	2.3	21.4
1	185	12.95	0.82	1.29	2.2	26.4
1	240	16.8	0.92	1.26	2.2	34.3
1	300	21	1	1.24	2.2	42.8
1	400	28	1.12	1.22	2.1	56.9
1	500	35	1.26	1.21	2.1	71.5
1	630	44.1	1.4	1.20	2.1	90.2
1	800	56	1.56	1.19	2.0	114
1	1000	70	1.72	1.19	2.0	143



OUR CERTIFICATION
ISO 9001 | ISO 14001 | ISO 45001



OUR CERTIFICATION
ISO 9001 | ISO 14001 | ISO 45001



POLYCAB SINGLE CORE MV AS/NZS 1429.1 6.35/11 (12) KV
MV Cable with Aluminium Conductor, XLPE Insulation, Copper Screen and Unarmoured

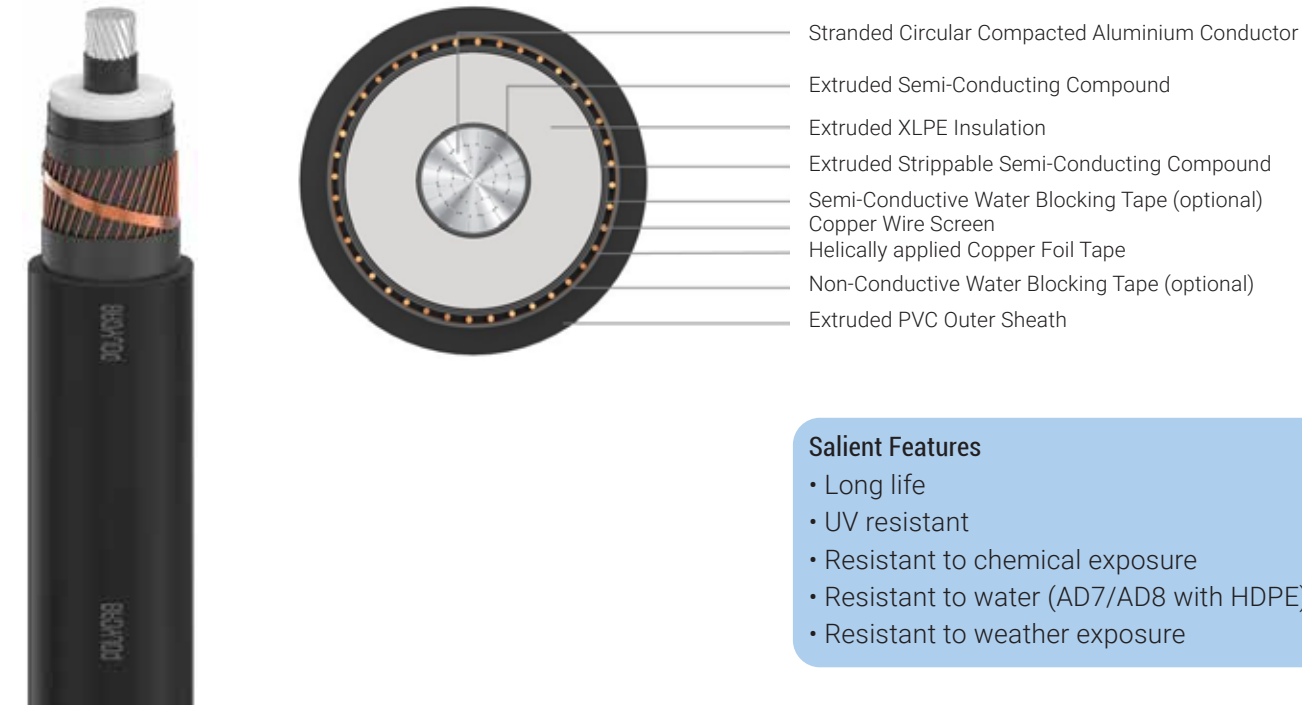

- Salient Features**
- Long life
 - UV resistant
 - Resistant to chemical exposure
 - Resistant to water (AD7/AD8 with HDPE)
 - Resistant to weather exposure

Application
POLYCAB MV 6.35/11 KV XLPE insulated with Aluminium conductor single core cable is suitable to use for power supply to wide networks i.e. Commercial, Industrial and Urban / Residential.

Voltage Rating
Nominal Voltage: 6.35/11 (12) kV

Operation Temperature
Min. installation temperature: 0°C
Operating temperature: -25°C to +90°C
Emergency operating temperature: 105°C
(max. operation of 36hrs, at 3 periods for 12 consecutive months use)
Max. Short Circuit Temperature: 250°C

- Construction**
- Conductor: Stranded Compacted Circular aluminium conductor as per AS/NZS 1125
 - Conductor Screen: Extruded Semi-conductive compound
 - Insulation: XLPE
 - Insulation Screen: Extruded strippable Semi-conductive compound
 - Longitudinal Water blocking : Water blocking tape above and below copper screen (Optional)
 - Metallic Insulation Screen: Copper Wire Screen + helicly applied copper tape (E/F current capacity – Based on requirement)
 - Metallic Sheath: Lead Alloy (optional)
 - Outer Sheath: Extruded Polyvinyl Chloride, Colour: Black
(Alternative Sheath: PVC+HDPE Composite Sheath or LSZH Outer sheath and parameters will change accordingly)

Bending Radius: 20D
Fixed Installation: 12D (PVC) / 15D (HDPE)
During Installation: 18D (PVC) / 25D (HDPE)

D is overall diameter of cable

Standard and References:
AS/NZS 1429.1
AS/NZS 1125
AS/NZS 3808

High Voltage Test (kV AC)	Partial discharge test (kV AC)		Impulse test Voltage (kV peak)
	200% to rated voltage	150% to rated voltage	
21	13	10	95

- Compliance**
- Conductor resistance AS/NZS 1125
 - Insulation resistance AS/NZS 1429.1
 - Voltage test AS/NZS 1429.1



POLYCAB SINGLE CORE MV AS/NZS 1429.1 6.35/11 (12) KV
MV Cable with Aluminium Conductor, XLPE Insulation, Copper Screen and Unarmoured

DIMENSIONAL CHARACTERISTICS:

Product Code	No. of Cores	Core Cross sectional Area	Nominal Diameter		
			Under metallic screen	Over metallic screen	Overall
	No.	mm ²	mm	mm	mm
MVNZ17AXUAPH001C016SAXXXX	1	16	14.6	16.5	20.0
MVNZ17AXUAPH001C025SAXXXX	1	25	15.9	17.8	22.0
MVNZ17AXUAPH001C035SAXXXX	1	35	16.9	18.8	23.0
MVNZ17AXUAPH001C050SAXXXX	1	50	18	19.9	24.0
MVNZ17AXUAPH001C070SAXXXX	1	70	19.6	21.5	25.0
MVNZ17AXUAPH001C095SAXXXX	1	95	21.2	23.1	27.0
MVNZ17AXUAPH001C120SAXXXX	1	120	22.8	24.7	29.0
MVNZ17AXUAPH001C150SAXXXX	1	150	24.1	26.0	30.0
MVNZ17AXUAPH001C185SAXXXX	1	185	25.8	27.7	32.0
MVNZ17AXUAPH001C240SAXXXX	1	240	28.1	30.0	34.0
MVNZ17AXUAPH001C300SAXXXX	1	300	30.3	32.2	37.0
MVNZ17AXUAPH001C400SAXXXX	1	400	33	34.9	40.0
MVNZ17AXUAPH001C500SAXXXX	1	500	36.4	38.3	43.0
MVNZ17AXUAPH001C630SAXXXX	1	630	39.6	41.5	47.0
MVNZ17AXUAPH001C800SAXXXX	1	800	43.5	45.4	51.0
MVNZ17AXUAPH001C01KSAXXXX	1	1000	48	49.9	55.0

- Above mentioned parameters are based on 3kA/sec earth fault current capacity of copper screen



POLYCAB SINGLE CORE MV AS/NZS 1429.1 6.35/11 (12) KV
MV Cable with Aluminium Conductor, XLPE Insulation, Copper Screen and Unarmoured

ELECTRICAL CHARACTERISTICS:

No. of Cores	Core Cross sectional Area	Max. DC Resistance at 20°C	Max. AC Resistance at 90°C	Approx. Capacitance	Approx. Inductance	Approx. Reactance	Continuous Current Rating					
							In ground at 20°C		In Duct at 20°C		In air at 30°C	
							Flat	Trefoil	Flat	Trefoil	Flat	Trefoil
No.	mm ²	Ω/km	Ω/km	μF/km	mH/km	Ω/km	Amps					
1	16	1.91	2.449	0.17	0.497	0.156	88	84	81	80	99	97
1	25	1.2	1.539	0.2	0.460	0.144	112	108	103	102	130	127
1	35	0.868	1.113	0.22	0.437	0.137	134	129	123	122	157	154
1	50	0.641	0.822	0.25	0.417	0.131	157	152	146	142	189	184
1	70	0.443	0.568	0.28	0.385	0.121	192	186	178	176	236	230
1	95	0.32	0.411	0.31	0.367	0.115	229	221	213	210	287	280
1	120	0.253	0.325	0.35	0.349	0.110	260	252	242	240	332	324
1	150	0.206	0.265	0.37	0.340	0.107	288	281	271	267	376	368
1	185	0.164	0.211	0.41	0.329	0.103	324	317	307	303	432	424
1	240	0.125	0.161	0.46	0.317	0.099	373	367	356	351	511	502
1	300	0.1	0.130	0.5	0.306	0.096	419	414	402	397	586	577
1	400	0.0778	0.102	0.56	0.296	0.093	466	470	457	451	676	673
1	500	0.0605	0.080	0.63	0.286	0.090	525	530	510	505	760	750
1	630	0.0469	0.064	0.69	0.279	0.088	580	585	560	555	860	850
1	800	0.0367	0.052	0.77	0.271	0.085	650	655	620	615	960	950
1	1000	0.0291	0.043	0.86	0.263	0.083	715	705	670	665	1060	1050

*: Current Ratings are based on IEC 60502-2 & IEC 60287, Max. Conductor Temperature at 90°C, Ambient temperature at 30°C in Air / at 20°C in Ground, Thermal resistivity of Soil 1.5 k.m/W & for earthenware ducts 1.2k.m/W and Depth of Laying 0.8m.

Current rating de-rating factors for other than 30°C ambient air temperature.

20	25	35	40	45	50	55	60
1.08	1.04	0.96	0.91	0.87	0.82	0.76	0.71

Current rating de-rating factors for other than 20°C ground temperature.

10	15	25	30	35	40	45	50
1.07	1.04	0.96	0.93	0.89	0.85	0.80	0.76

POLYCAB SINGLE CORE MV AS/NZS 1429.1 6.35/11 (12) KV
MV Cable with Aluminium Conductor, XLPE Insulation, Copper Screen and Unarmoured

No. of Cores	Core Cross sectional Area	Max. pulling tension on conductor	Charging Current per phase	Zero sequence impedance	Electric Stress at Conductor Screen	Short circuit rating of Phase conductor
No.	mm ²	kN	Amps/Km	Ohms/Km	kV/mm	kA, 1 sec
1	16	0.8	0.34	3.61	2.9	1.5
1	25	1.25	0.4	2.70	2.7	2.4
1	35	1.75	0.44	2.27	2.6	3.3
1	50	2.5	0.5	1.98	2.5	4.7
1	70	3.5	0.56	1.73	2.4	6.6
1	95	4.75	0.62	1.57	2.3	9.0
1	120	6	0.7	1.49	2.3	11.3
1	150	7.5	0.74	1.42	2.3	14.2
1	185	9.25	0.82	1.37	2.2	17.4
1	240	12	0.92	1.32	2.2	22.6
1	300	15	1	1.29	2.2	28.3
1	400	20	1.12	1.26	2.1	37.6
1	500	25	1.26	1.24	2.1	47.2
1	630	31.5	1.38	1.22	2.1	59.6
1	800	40	1.54	1.21	2.0	75.6
1	1000	50	1.72	1.20	2.0	94.5



OUR CERTIFICATION
 ISO 9001 | ISO 14001 | ISO 45001



OUR CERTIFICATION
 ISO 9001 | ISO 14001 | ISO 45001



POLYCAB SINGLE CORE ANTI-TERMITE MV AS/NZS 1429.1 6.35/11 (12) KV
MV Cable with Aluminium Conductor, XLPE Insulation, Copper Screen and Unarmoured

POLYCAB SINGLE CORE ANTI-TERMITE MV AS/NZS 1429.1 6.35/11 (12) KV
MV Cable with Aluminium Conductor, XLPE Insulation, Copper Screen and Unarmoured

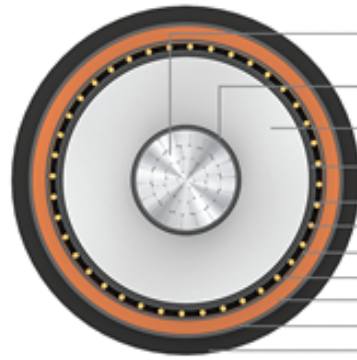

- Stranded Circular Compacted Aluminium Conductor
- Extruded Semi-Conducting Compound
- Extruded XLPE Insulation
- Extruded Strippable Semi-Conducting Compound
- Semi-Conductive Water Blocking Tape (optional)
- Copper Wire Screen
- Helically applied Copper Foil Tape
- Non-Conductive Water Blocking Tape (optional)
- Extruded PVC Inner layer
- Polyamide (Nylon-12) Anti-Termite layer
- Extruded HDPE outer sheath

Salient Features

- Long life
- UV resistant
- Resistant to chemical exposure
- Resistant to weather exposure
- Resistant to water (AD7/AD8)
- Termite resistant

Application
POLYCAB MV 6.35/11 KV XLPE insulated with Aluminium conductor single core cable is suitable to use for power supply to wide networks i.e. Commercial, Industrial and Urban / Residential.

Voltage Rating
Nominal Voltage: 6.35/11 (12) KV

Operation Temperature
Min. installation temperature: 0°C
Operating temperature: -25°C to +90°C
Emergency operating temperature: 105°C
(max. operation of 36hrs, at 3 periods for 12 consecutive months use)
Max. Short Circuit Temperature: 250°C

- Construction**
- Conductor: Stranded Compacted Circular aluminium conductor as per AS/NZS 1125
 - Conductor Screen: Extruded Semi-conductive compound
 - Insulation: XLPE
 - Insulation Screen: Extruded strippable Semi-conductive compound
 - Longitudinal Water blocking : Water blocking tape above and below copper screen (Optional)
 - Metallic Insulation Screen: Copper Wire Screen + helically applied copper tape (E/F current capacity – Based on requirement)
- Composite sheath**
- Inner layer : Extruded Polyvinyl Chloride, Colour: Orange
 - Termite Protection: Polyamide (Nylon -12)
 - Outer layer: HDPE (Black)

Bending Radius: 20D
Fixed Installation: 20D
During Installation: 30D

D is diameter over nylon

Standard and References:
AS/NZS 1429.1
AS/NZS 1125
AS/NZS 3808

High Voltage Test (kV AC)	Partial discharge test (kV AC)		Impulse test Voltage (kV peak)
	200% to rated voltage	150% to rated voltage	
21	13	10	95

- Compliance**
- Conductor resistance AS/NZS 1125
 - Insulation resistance AS/NZS 1429.1
 - Voltage test AS/NZS 1429.1



DIMENSIONAL CHARACTERISTICS:

Product Code	No. of Cores	Core Cross sectional Area	Nominal Diameter		
			Under metallic screen	Over metallic screen	Overall
	No.	mm ²	mm	mm	mm
MVNZ17AXUAPH001C016SAXXXX	1	16	14.6	16.5	21.0
MVNZ17AXUAPH001C025SAXXXX	1	25	15.9	17.8	24.0
MVNZ17AXUAPH001C035SAXXXX	1	35	16.9	18.8	25.0
MVNZ17AXUAPH001C050SAXXXX	1	50	18	19.9	26.0
MVNZ17AXUAPH001C070SAXXXX	1	70	19.6	21.5	28.0
MVNZ17AXUAPH001C095SAXXXX	1	95	21.2	23.1	29.0
MVNZ17AXUAPH001C120SAXXXX	1	120	22.8	24.7	31.0
MVNZ17AXUAPH001C150SAXXXX	1	150	24.1	26.0	32.0
MVNZ17AXUAPH001C185SAXXXX	1	185	25.8	27.7	34.0
MVNZ17AXUAPH001C240SAXXXX	1	240	28.1	30.0	36.0
MVNZ17AXUAPH001C300SAXXXX	1	300	30.3	32.2	39.0
MVNZ17AXUAPH001C400SAXXXX	1	400	33	34.9	42.0
MVNZ17AXUAPH001C500SAXXXX	1	500	36.4	38.3	45.0
MVNZ17AXUAPH001C630SAXXXX	1	630	39.6	41.5	49.0
MVNZ17AXUAPH001C800SAXXXX	1	800	43.5	45.4	53.0
MVNZ17AXUAPH001C01KSAXXXX	1	1000	48	49.9	58.0

- Above mentioned parameters are based on 3kA/sec earth fault current capacity of copper screen



POLYCAB SINGLE CORE ANTI-TERMITE MV AS/NZS 1429.1 6.35/11 (12) KV
MV Cable with Aluminium Conductor, XLPE Insulation, Copper Screen and Unarmoured

POLYCAB SINGLE CORE ANTI-TERMITE MV AS/NZS 1429.1 6.35/11 (12) KV
MV Cable with Aluminium Conductor, XLPE Insulation, Copper Screen and Unarmoured

ELECTRICAL CHARACTERISTICS:

No. of Cores	Core Cross sectional Area	Max. DC Resistance at 20°C	Max. AC Resistance at 90°C	Approx. Capacitance	Approx. Inductance	Approx. Reactance	Continuous Current Rating					
							In ground at 20°C		In Duct at 20°C		In air at 30°C	
							Flat	Trefoil	Flat	Trefoil	Flat	Trefoil
No.	mm ²	Ω/km	Ω/km	μF/km	mH/km	Ω/km	Amps					
1	16	1.91	2.449	0.17	0.504	0.158	88	84	81	80	99	97
1	25	1.2	1.539	0.2	0.479	0.150	112	108	103	102	130	127
1	35	0.868	1.113	0.22	0.456	0.143	134	129	123	122	157	154
1	50	0.641	0.822	0.25	0.435	0.137	157	152	146	142	189	184
1	70	0.443	0.568	0.28	0.402	0.126	192	186	178	176	236	230
1	95	0.32	0.411	0.31	0.383	0.120	229	221	213	210	287	280
1	120	0.253	0.325	0.35	0.364	0.114	260	252	242	240	332	324
1	150	0.206	0.265	0.37	0.353	0.111	288	281	271	267	376	368
1	185	0.164	0.211	0.41	0.341	0.107	324	317	307	303	432	424
1	240	0.125	0.161	0.46	0.327	0.103	373	367	356	351	511	502
1	300	0.1	0.130	0.5	0.316	0.099	419	414	402	397	586	577
1	400	0.0778	0.102	0.56	0.306	0.096	466	470	457	451	676	673
1	500	0.0605	0.080	0.63	0.296	0.093	525	530	510	505	760	750
1	630	0.0469	0.064	0.69	0.288	0.091	580	585	560	555	860	850
1	800	0.0367	0.051	0.77	0.280	0.088	650	655	620	615	960	950
1	1000	0.0291	0.043	0.86	0.272	0.086	715	705	670	665	1060	1050

*: Current Ratings are based on IEC 60502-2 & IEC 60287, Max. Conductor Temperature at 90°C, Ambient temperature at 30°C in Air / at 20°C in Ground, Thermal resistivity of Soil 1.5 k.m/W & for earthenware ducts 1.2k.m/W and Depth of Laying 0.8m.

Current rating de-rating factors for other than 30°C ambient air temperature.

20	25	35	40	45	50	55	60
1.08	1.04	0.96	0.91	0.87	0.82	0.76	0.71

Current rating de-rating factors for other than 20°C ground temperature.

10	15	25	30	35	40	45	50
1.07	1.04	0.96	0.93	0.89	0.85	0.80	0.76

No. of Cores	Core Cross sectional Area	Max. pulling tension on conductor	Charging Current per phase	Zero sequence impedance	Electric Stress at Conductor Screen	Short circuit rating of Phase conductor
No.	mm ²	kN	Amps/Km	Ohms/Km	kV/mm	kA, 1 sec
1	16	0.8	0.34	3.61	2.9	1.5
1	25	1.25	0.4	2.70	2.7	2.4
1	35	1.75	0.44	2.27	2.6	3.3
1	50	2.5	0.5	1.98	2.5	4.7
1	70	3.5	0.56	1.73	2.4	6.6
1	95	4.75	0.62	1.57	2.3	9.0
1	120	6	0.7	1.49	2.3	11.3
1	150	7.5	0.74	1.42	2.3	14.2
1	185	9.25	0.82	1.37	2.2	17.4
1	240	12	0.92	1.32	2.2	22.6
1	300	15	1	1.29	2.2	28.3
1	400	20	1.12	1.26	2.1	37.6
1	500	25	1.26	1.24	2.1	47.2
1	630	31.5	1.38	1.22	2.1	59.6
1	800	40	1.54	1.21	2.0	75.6
1	1000	50	1.72	1.20	2.0	94.5



OUR CERTIFICATION
ISO 9001 | ISO 14001 | ISO 45001



OUR CERTIFICATION
ISO 9001 | ISO 14001 | ISO 45001



POLYCAB SINGLE CORE MV AS/NZS 1429.1 12.7/22 (24) KV
MV Cable with Copper Conductor, XLPE Insulation, Copper Screen and Unarmoured

POLYCAB SINGLE CORE MV AS/NZS 1429.1 12.7/22 (24) KV
MV Cable with Copper Conductor, XLPE Insulation, Copper Screen and Unarmoured

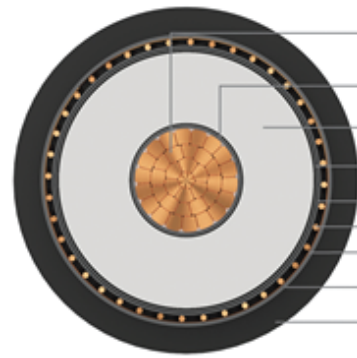

- Stranded Circular Compacted Copper Conductor
- Extruded Semi-Conducting Compound
- Extruded XLPE Insulation
- Extruded Strippable Semi-Conducting Compound
- Semi-Conductive Water Blocking Tape (optional)
- Copper Wire Screen
- Helicly applied Copper Foil Tape
- Non-Conductive Water Blocking Tape (optional)
- Extruded PVC Outer sheath

Salient Features

- Long life
- UV resistant
- Resistant to chemical exposure
- Resistant to water (AD7/AD8 with HDPE)
- Resistant to weather exposure
- Termite resistant (Optional)

Application
POLYCAB MV 12.7/22 KV XLPE insulated with Copper conductor single core cable is suitable to use for power supply to wide networks i.e. Commercial, Industrial and Urban / Residential.

Voltage Rating
Nominal Voltage: 12.7/22 (24) KV

Operation Temperature
Min. installation temperature: 0°C
Operating temperature: -25°C to +90°C
Emergency operating temperature: 105°C
(max. operation of 36hrs, at 3 periods for 12 consecutive months use)
Max. Short Circuit Temperature: 250°C

- Construction**
- Conductor: Stranded Compacted Circular Copper conductor as per AS/NZS 1125
 - Conductor Screen: Extruded Semi-conductive compound
 - Insulation: XLPE
 - Insulation Screen: Extruded Strippable Semi-conductive compound
 - Longitudinal Water blocking : Water blocking tape above and below copper screen (Optional)
 - Metallic Insulation Screen: Copper Wire Screen + helicly applied copper tape (E/F current capacity – Based on requirement)
 - Metallic Sheath: Lead Alloy (optional)
 - Termite Protection: Polyamide (Nylon -12) (optional)
 - (Alternative Sheath: PVC+HDPE Composite Sheath or PVC + Nylon + HDPE (composite sheath with anti-termite properties) or LSZH Outer sheath, and parameters will change accordingly)

Bending Radius: 20D
Fixed Installation: 12D (PVC) / 15D (HDPE) / 20D (Nylon)
During Installation: 18D (PVC) / 25D (HDPE) / 30D (Nylon)

D is overall diameter of cable

Standard and References:
AS/NZS 1429.1
AS/NZS 1125
AS/NZS 3808

High Voltage Test (kV AC)	Partial discharge test (kV AC)		Impulse test Voltage (kV peak)
	200% to rated voltage	150% to rated voltage	
42	25	19	150

- Compliance**
- Conductor resistance AS/NZS 1125
 - Insulation resistance AS/NZS 1429.1
 - Voltage test AS/NZS 1429.1



DIMENSIONAL CHARACTERISTICS:

Product Code	No. of Cores	Core Cross sectional Area	Nominal Diameter		
			Under metallic screen	Over metallic screen	Overall
	No.	mm ²	mm	mm	mm
MVNZ54CXUAPH001C035SAXXXX	1	35	21.1	23.0	27.0
MVNZ54CXUAPH001C050SAXXXX	1	50	22.2	24.1	28.0
MVNZ54CXUAPH001C070SAXXXX	1	70	23.9	25.8	30.0
MVNZ54CXUAPH001C095SAXXXX	1	95	25.4	27.3	31.0
MVNZ54CXUAPH001C120SAXXXX	1	120	27	28.9	33.0
MVNZ54CXUAPH001C150SAXXXX	1	150	28.4	30.3	35.0
MVNZ54CXUAPH001C185SAXXXX	1	185	30.1	32.0	37.0
MVNZ54CXUAPH001C240SAXXXX	1	240	32.4	34.3	39.0
MVNZ54CXUAPH001C300SAXXXX	1	300	34.4	36.3	41.0
MVNZ54CXUAPH001C400SAXXXX	1	400	37.2	39.1	44.0
MVNZ54CXUAPH001C500SAXXXX	1	500	40.6	42.5	48.0
MVNZ54CXUAPH001C630SAXXXX	1	630	44.2	46.1	51.0
MVNZ54CXUAPH001C800SAXXXX	1	800	47.9	49.8	55.0
MVNZ54CXUAPH001C01KSAXXXX	1	1000	52.2	54.1	60.0

- Above mentioned parameters are based on 3kA/sec earth fault current capacity of copper screen



POLYCAB SINGLE CORE MV AS/NZS 1429.1 12.7/22 (24) KV
 MV Cable with Copper Conductor, XLPE Insulation, Copper Screen and Unarmoured

ELECTRICAL CHARACTERISTICS:

No. of Cores	Core Cross sectional Area	Max. DC Resistance at 20°C	Max. AC Resistance at 90°C	Approx. Capacitance	Approx. Inductance	Approx. Reactance	Continuous Current Rating					
							In ground at 20°C		In Duct at 20°C		In air at 30°C	
							Flat	Trefoil	Flat	Trefoil	Flat	Trefoil
No.	mm ²	Ω/km	Ω/km	μF/km	mH/km	Ω/km	Amps					
1	35	0.524	0.668	0.16	0.472	0.148	172	166	159	157	203	198
1	50	0.387	0.494	0.17	0.450	0.142	203	196	188	186	243	238
1	70	0.268	0.342	0.2	0.416	0.131	246	239	229	227	303	296
1	95	0.193	0.247	0.22	0.397	0.125	293	285	274	271	369	361
1	120	0.153	0.196	0.24	0.379	0.119	332	323	311	308	426	417
1	150	0.124	0.159	0.26	0.367	0.115	366	361	347	343	481	473
1	185	0.0991	0.128	0.28	0.355	0.112	410	406	391	387	550	543
1	240	0.0754	0.098	0.31	0.340	0.107	470	469	453	447	647	641
1	300	0.0601	0.079	0.33	0.329	0.103	524	526	510	504	739	735
1	400	0.047	0.063	0.37	0.318	0.100	572	590	571	564	837	845
1	500	0.0366	0.051	0.41	0.306	0.096	660	655	640	635	970	960
1	630	0.0283	0.041	0.46	0.296	0.093	735	730	715	710	1110	1100
1	800	0.0221	0.034	0.5	0.287	0.090	770	820	800	790	1260	1250
1	1000	0.0176	0.030	0.56	0.279	0.088	825	885	865	855	1420	1410

*: Current Ratings are based on IEC 60502-2 & IEC 60287, Max. Conductor Temperature at 90°C, Ambient temperature at 30°C in Air / at 20°C in Ground, Thermal resistivity of Soil 1.5 k.m/W & for earthenware ducts 1.2k.m/W and Depth of Laying 0.8m.

Current rating de-rating factors for other than 30°C ambient air temperature.

20	25	35	40	45	50	55	60
1.08	1.04	0.96	0.91	0.87	0.82	0.76	0.71

Current rating de-rating factors for other than 20°C ground temperature.

10	15	25	30	35	40	45	50
1.07	1.04	0.96	0.93	0.89	0.85	0.80	0.76

POLYCAB SINGLE CORE MV AS/NZS 1429.1 12.7/22 (24) KV
 MV Cable with Copper Conductor, XLPE Insulation, Copper Screen and Unarmoured

No. of Cores	Core Cross sectional Area	Max. pulling tension on conductor	Charging Current per phase	Zero sequence impedance	Electric Stress at Conductor Screen	Short circuit rating of Phase conductor
No.	mm ²	kN	Amps/Km	Ohms/Km	kV/mm	kA, 1 sec
1	35	2.45	0.64	1.83	3.7	5.0
1	50	3.5	0.68	1.66	3.5	7.2
1	70	4.9	0.8	1.50	3.4	10.0
1	95	6.65	0.88	1.41	3.2	13.6
1	120	8.4	0.96	1.36	3.1	17.1
1	150	10.5	1.04	1.32	3.1	21.4
1	185	12.95	1.12	1.29	3.0	26.4
1	240	16.8	1.24	1.26	2.9	34.3
1	300	21	1.32	1.24	2.9	42.8
1	400	28	1.48	1.22	2.8	56.9
1	500	35	1.64	1.21	2.7	71.5
1	630	44.1	1.84	1.20	2.7	90.2
1	800	56	1.99	1.19	2.7	114
1	1000	70	2.23	1.19	2.6	143



OUR CERTIFICATION
 ISO 9001 | ISO 14001 | ISO 45001



OUR CERTIFICATION
 ISO 9001 | ISO 14001 | ISO 45001



POLYCAB SINGLE CORE MV AS/NZS 1429.1 12.7/22 (24) KV
MV Cable with Aluminium Conductor, XLPE Insulation, Copper Screen and Unarmoured

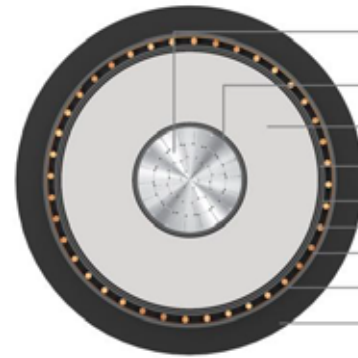

- Stranded Circular Compacted Aluminium Conductor
- Extruded Semi-Conducting Compound
- Extruded XLPE Insulation
- Extruded Strippable Semi-Conducting Compound
- Semi-Conductive Water Blocking Tape (optional)
- Copper Wire Screen
- Helicly applied Copper Foil Tape
- Non-Conductive Water Blocking Tape (optional)
- Extruded PVC Outer sheath

- Salient Features**
- Long life
 - UV resistant
 - Resistant to chemical exposure
 - Resistant to water (AD7/AD8 with HDPE)
 - Resistant to weather exposure

Application
POLYCAB MV 12.7/22 KV XLPE insulated with Aluminium conductor single core cable is suitable to use for power supply to wide networks i.e. Commercial, Industrial and Urban / Residential.

Voltage Rating
Nominal Voltage: 12.7/22 (24) kV

Operation Temperature
Min. installation temperature: 0°C
Operating temperature: -25°C to +90°C
Emergency operating temperature: 105°C
(max. operation of 36hrs, at 3 periods for 12 consecutive months use)
Max. Short Circuit Temperature: 250°C

- Construction**
- Conductor: Stranded Compacted Circular aluminium conductor as per AS/NZS 1125
 - Conductor Screen: Extruded Semi-conductive compound
 - Insulation: XLPE
 - Insulation Screen: Extruded strippable Semi-conductive compound
 - Longitudinal Water blocking : Water blocking tape above and below copper screen (Optional)
 - Metallic Insulation Screen: Copper Wire Screen + helicly applied copper tape (E/F current capacity – Based on requirement)
 - Metallic Sheath: Lead Alloy (optional)
 - Outer Sheath: Extruded Polyvinyl Chloride, Colour: Black
(Alternative Sheath: PVC+HDPE Composite Sheath or LSZH Outer sheath and parameters will change accordingly)

Bending Radius: 20D
Fixed Installation: 12D (PVC) / 15D (HDPE)
During Installation: 18D (PVC) / 25D (HDPE)

D is overall diameter of cable

Standard and References:
AS/NZS 1429.1
AS/NZS 1125
AS/NZS 3808

High Voltage Test (kV AC)	Partial discharge test (kV AC)		Impulse test Voltage (kV peak)
	200% to rated voltage	150% to rated voltage	
42	25	19	150

- Compliance**
- Conductor resistance AS/NZS 1125
 - Insulation resistance AS/NZS 1429.1
 - Voltage test AS/NZS 1429.1



POLYCAB SINGLE CORE MV AS/NZS 1429.1 12.7/22 (24) KV
MV Cable with Aluminium Conductor, XLPE Insulation, Copper Screen and Unarmoured

DIMENSIONAL CHARACTERISTICS:

Product Code	No. of Cores	Core Cross sectional Area	Nominal Diameter		
			Under metallic screen	Over metallic screen	Overall
	No.	mm ²	mm	mm	mm
MVNZ54AXUAPH001C035SAXXXX	1	35	21.1	23.0	27.0
MVNZ54AXUAPH001C050SAXXXX	1	50	22.2	24.1	28.0
MVNZ54AXUAPH001C070SAXXXX	1	70	23.8	25.7	30.0
MVNZ54AXUAPH001C095SAXXXX	1	95	25.4	27.3	31.0
MVNZ54AXUAPH001C120SAXXXX	1	120	27	28.9	33.0
MVNZ54AXUAPH001C150SAXXXX	1	150	28.3	30.2	35.0
MVNZ54AXUAPH001C185SAXXXX	1	185	30	31.9	36.0
MVNZ54AXUAPH001C240SAXXXX	1	240	32.3	34.2	39.0
MVNZ54AXUAPH001C300SAXXXX	1	300	34.5	36.4	41.0
MVNZ54AXUAPH001C400SAXXXX	1	400	37.2	39.1	44.0
MVNZ54AXUAPH001C500SAXXXX	1	500	40.6	42.5	48.0
MVNZ54AXUAPH001C630SAXXXX	1	630	43.8	45.7	51.0
MVNZ54AXUAPH001C800SAXXXX	1	800	47.7	49.6	55.0
MVNZ54AXUAPH001C01KSAXXXX	1	1000	52.2	54.1	60.0

- Above mentioned parameters are based on 3kA/sec earth fault current capacity of copper screen



POLYCAB SINGLE CORE MV AS/NZS 1429.1 12.7/22 (24) KV
 MV Cable with Aluminium Conductor, XLPE Insulation, Copper Screen and Unarmoured

ELECTRICAL CHARACTERISTICS:

No. of Cores	Core Cross sectional Area	Max. DC Resistance at 20°C	Max. AC Resistance at 90°C	Approx. Capacitance	Approx. Inductance	Approx. Reactance	Continuous Current Rating					
							In ground at 20°C		In Duct at 20°C		In air at 30°C	
							Flat	Trefoil	Flat	Trefoil	Flat	Trefoil
No.	mm ²	Ω/km	Ω/km	μF/km	mH/km	Ω/km	Amps					
1	35	0.868	1.113	0.16	0.472	0.148	134	129	123	122	157	154
1	50	0.641	0.822	0.17	0.450	0.142	157	152	146	142	189	184
1	70	0.443	0.568	0.2	0.418	0.131	192	186	178	176	236	230
1	95	0.32	0.411	0.22	0.397	0.125	229	221	213	210	287	280
1	120	0.253	0.325	0.24	0.379	0.119	260	252	242	240	332	324
1	150	0.206	0.265	0.25	0.368	0.116	288	281	271	267	376	368
1	185	0.164	0.211	0.28	0.356	0.112	324	317	307	303	432	424
1	240	0.125	0.161	0.31	0.341	0.107	373	367	356	351	511	502
1	300	0.1	0.130	0.33	0.329	0.103	419	414	402	397	586	577
1	400	0.0778	0.102	0.37	0.318	0.100	466	470	457	451	676	673
1	500	0.0605	0.080	0.41	0.306	0.096	525	530	510	505	760	750
1	630	0.0469	0.063	0.45	0.297	0.093	580	585	560	555	860	850
1	800	0.0367	0.051	0.5	0.288	0.090	650	655	620	615	960	950
1	1000	0.0291	0.043	0.56	0.279	0.088	715	705	670	665	1060	1050

*: Current Ratings are based on IEC 60502-2 & IEC 60287, Max. Conductor Temperature at 90°C, Ambient temperature at 30°C in Air / at 20°C in Ground, Thermal resistivity of Soil 1.5 k.m/W & for earthenware ducts 1.2k.m/W and Depth of Laying 0.8m.

Current rating de-rating factors for other than 30°C ambient air temperature.

20	25	35	40	45	50	55	60
1.08	1.04	0.96	0.91	0.87	0.82	0.76	0.71

Current rating de-rating factors for other than 20°C ground temperature.

10	15	25	30	35	40	45	50
1.07	1.04	0.96	0.93	0.89	0.85	0.80	0.76

POLYCAB SINGLE CORE MV AS/NZS 1429.1 12.7/22 (24) KV
 MV Cable with Aluminium Conductor, XLPE Insulation, Copper Screen and Unarmoured

No. of Cores	Core Cross sectional Area	Max. pulling tension on conductor	Charging Current per phase	Zero sequence impedance	Electric Stress at Conductor Screen	Short circuit rating of Phase conductor
No.	mm ²	kN	Amps/Km	Ohms/Km	kV/mm	kA, 1 sec
1	35	1.75	0.64	2.27	3.7	3.3
1	50	2.5	0.68	1.98	3.5	4.7
1	70	3.5	0.8	1.73	3.4	6.6
1	95	4.75	0.88	1.57	3.2	9.0
1	120	6	0.96	1.49	3.1	11.3
1	150	7.5	1	1.43	3.1	14.2
1	185	9.25	1.12	1.37	3.0	17.4
1	240	12	1.24	1.32	2.9	22.6
1	300	15	1.32	1.29	2.9	28.3
1	400	20	1.48	1.26	2.8	37.6
1	500	25	1.64	1.24	2.7	47.2
1	630	31.5	1.8	1.22	2.7	59.6
1	800	40	1.99	1.21	2.7	75.6
1	1000	50	2.23	1.20	2.6	94.5



OUR CERTIFICATION
 ISO 9001 | ISO 14001 | ISO 45001



OUR CERTIFICATION
 ISO 9001 | ISO 14001 | ISO 45001



POLYCAB SINGLE CORE ANTI-TERMITE MV AS/NZS 1429.1 12.7/22 (24) KV
MV Cable with Aluminium Conductor, XLPE Insulation, Copper Screen and Unarmoured

POLYCAB SINGLE CORE ANTI-TERMITE MV AS/NZS 1429.1 12.7/22 (24) KV
MV Cable with Aluminium Conductor, XLPE Insulation, Copper Screen and Unarmoured

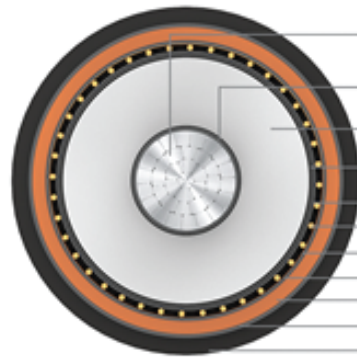

- Stranded Circular Compacted Aluminium Conductor
- Extruded Semi-Conducting Compound
- Extruded XLPE Insulation
- Extruded Strippable Semi-Conducting Compound
- Semi-Conductive Water Blocking Tape (optional)
- Copper Wire Screen
- Helically applied Copper Foil Tape
- Non-Conductive Water Blocking Tape (optional)
- Extruded PVC Inner layer
- Polyamide (Nylon-12) Anti-Termite layer
- Extruded HDPE outer sheath

Salient Features

- Long life
- UV resistant
- Resistant to chemical exposure
- Resistant to weather exposure
- Resistant to water (AD7/AD8)
- Termite resistant

Application
POLYCAB MV 12.7/22 KV XLPE insulated with Aluminium conductor single core cable is suitable to use for power supply to wide networks i.e. Commercial, Industrial and Urban / Residential.

Voltage Rating
Nominal Voltage: 12.7/22 (24) kV

Operation Temperature
Min. installation temperature: 0°C
Operating temperature: -25°C to +90°C
Emergency operating temperature: 105°C
(max. operation of 36hrs, at 3 periods for 12 consecutive months use)
Max. Short Circuit Temperature: 250°C

- Construction**
- Conductor: Stranded Compacted Circular aluminium conductor as per AS/NZS 1125
 - Conductor Screen: Extruded Semi-conductive compound
 - Insulation: XLPE
 - Insulation Screen: Extruded strippable Semi-conductive compound
 - Longitudinal Water blocking : Water blocking tape above and below copper screen (Optional)
 - Metallic Insulation Screen: Copper Wire Screen + helically applied copper tape (E/F current capacity – Based on requirement)
- Composite sheath**
- Inner layer: Extruded Polyvinyl Chloride, Colour: Orange
 - Termite Protection: Polyamide (Nylon -12)
 - Outer layer: HDPE (Black)

Bending Radius: 20D
Fixed Installation: 20D
During Installation: 30D

D is overall diameter of cable

Standard and References:
AS/NZS 1429.1
AS/NZS 1125
AS/NZS 3808

High Voltage Test (kV AC)	Partial discharge test (kV AC)		Impulse test Voltage (kV peak)
	200% to rated voltage	150% to rated voltage	
42	25	19	150

- Compliance**
- Conductor resistance AS/NZS 1125
 - Insulation resistance AS/NZS 1429.1
 - Voltage test AS/NZS 1429.1



DIMENSIONAL CHARACTERISTICS:

Product Code	No. of Cores	Core Cross sectional Area	Nominal Diameter		
			Under metallic screen	Over metallic screen	Overall
	No.	mm ²	mm	mm	mm
MVNZ54AXUAPH001C035SAXXXX	1	35	21.1	23.0	29.0
MVNZ54AXUAPH001C050SAXXXX	1	50	22.2	24.1	30.0
MVNZ54AXUAPH001C070SAXXXX	1	70	23.8	25.7	32.0
MVNZ54AXUAPH001C095SAXXXX	1	95	25.4	27.3	34.0
MVNZ54AXUAPH001C120SAXXXX	1	120	27	28.9	36.0
MVNZ54AXUAPH001C150SAXXXX	1	150	28.3	30.2	37.0
MVNZ54AXUAPH001C185SAXXXX	1	185	30	31.9	39.0
MVNZ54AXUAPH001C240SAXXXX	1	240	32.3	34.2	41.0
MVNZ54AXUAPH001C300SAXXXX	1	300	34.5	36.4	43.0
MVNZ54AXUAPH001C400SAXXXX	1	400	37.2	39.1	46.0
MVNZ54AXUAPH001C500SAXXXX	1	500	40.6	42.5	50.0
MVNZ54AXUAPH001C630SAXXXX	1	630	43.8	45.7	53.0
MVNZ54AXUAPH001C800SAXXXX	1	800	47.7	49.6	58.0
MVNZ54AXUAPH001C01KSAXXXX	1	1000	52.2	54.1	63.0

- Above mentioned parameters are based on 3kA/sec earth fault current capacity of copper screen



POLYCAB SINGLE CORE ANTI-TERMITE MV AS/NZS 1429.1 12.7/22 (24) KV
MV Cable with Aluminium Conductor, XLPE Insulation, Copper Screen and Unarmoured

ELECTRICAL CHARACTERISTICS:

No. of Cores	Core Cross sectional Area	Max. DC Resistance at 20°C	Max. AC Resistance at 90°C	Approx. Capacitance	Approx. Inductance	Approx. Reactance	Continuous Current Rating					
							In ground at 20°C		In Duct at 20°C		In air at 30°C	
							Flat	Trefoil	Flat	Trefoil	Flat	Trefoil
No.	mm ²	Ω/km	Ω/km	μF/km	mH/km	Ω/km	Amps					
1	35	0.868	1.113	0.16	0.488	0.153	134	129	123	122	157	154
1	50	0.641	0.822	0.17	0.466	0.146	157	152	146	142	189	184
1	70	0.443	0.568	0.2	0.433	0.136	192	186	178	176	236	230
1	95	0.32	0.411	0.22	0.412	0.129	229	221	213	210	287	280
1	120	0.253	0.325	0.24	0.394	0.124	260	252	242	240	332	324
1	150	0.206	0.265	0.25	0.380	0.119	288	281	271	267	376	368
1	185	0.164	0.211	0.28	0.368	0.116	324	317	307	303	432	424
1	240	0.125	0.161	0.31	0.351	0.110	373	367	356	351	511	502
1	300	0.1	0.129	0.33	0.339	0.106	419	414	402	397	586	577
1	400	0.0778	0.101	0.37	0.327	0.103	466	470	457	451	676	673
1	500	0.0605	0.080	0.41	0.315	0.099	525	530	510	505	760	750
1	630	0.0469	0.063	0.45	0.306	0.096	580	585	560	555	860	850
1	800	0.0367	0.051	0.5	0.296	0.093	650	655	620	615	960	950
1	1000	0.0291	0.042	0.56	0.288	0.091	715	705	670	665	1060	1050

*: Current Ratings are based on IEC 60502-2 & IEC 60287, Max. Conductor Temperature at 90°C, Ambient temperature at 30°C in Air / at 20°C in Ground, Thermal resistivity of Soil 1.5 k.m/W & for earthenware ducts 1.2k.m/W and Depth of Laying 0.8m.

Current rating de-rating factors for other than 30°C ambient air temperature.

20	25	35	40	45	50	55	60
1.08	1.04	0.96	0.91	0.87	0.82	0.76	0.71

Current rating de-rating factors for other than 20°C ground temperature.

10	15	25	30	35	40	45	50
1.07	1.04	0.96	0.93	0.89	0.85	0.80	0.76

POLYCAB SINGLE CORE ANTI-TERMITE MV AS/NZS 1429.1 12.7/22 (24) KV
MV Cable with Aluminium Conductor, XLPE Insulation, Copper Screen and Unarmoured

No. of Cores	Core Cross sectional Area	Max. pulling tension on conductor	Charging Current per phase	Zero sequence impedance	Electric Stress at Conductor Screen	Short circuit rating of Phase conductor
No.	mm ²	kN	Amps/Km	Ohms/Km	kV/mm	kA, 1 sec
1	35	1.75	0.64	2.27	3.7	3.3
1	50	2.5	0.68	1.98	3.5	4.7
1	70	3.5	0.8	1.73	3.4	6.6
1	95	4.75	0.88	1.57	3.2	9.0
1	120	6	0.96	1.49	3.1	11.3
1	150	7.5	1	1.43	3.1	14.2
1	185	9.25	1.12	1.37	3.0	17.4
1	240	12	1.24	1.32	2.9	22.6
1	300	15	1.32	1.29	2.9	28.3
1	400	20	1.48	1.26	2.8	37.6
1	500	25	1.64	1.24	2.7	47.2
1	630	31.5	1.8	1.22	2.7	59.6
1	800	40	1.99	1.21	2.7	75.6
1	1000	50	2.23	1.20	2.6	94.5



OUR CERTIFICATION
ISO 9001 | ISO 14001 | ISO 45001



OUR CERTIFICATION
ISO 9001 | ISO 14001 | ISO 45001



POLYCAB SINGLE CORE MV AS/NZS 1429.1 19/33 (36) KV
MV Cable with Copper Conductor, XLPE Insulation, Copper Screen and Unarmoured

POLYCAB SINGLE CORE MV AS/NZS 1429.1 19/33 (36) KV
MV Cable with Copper Conductor, XLPE Insulation, Copper Screen and Unarmoured

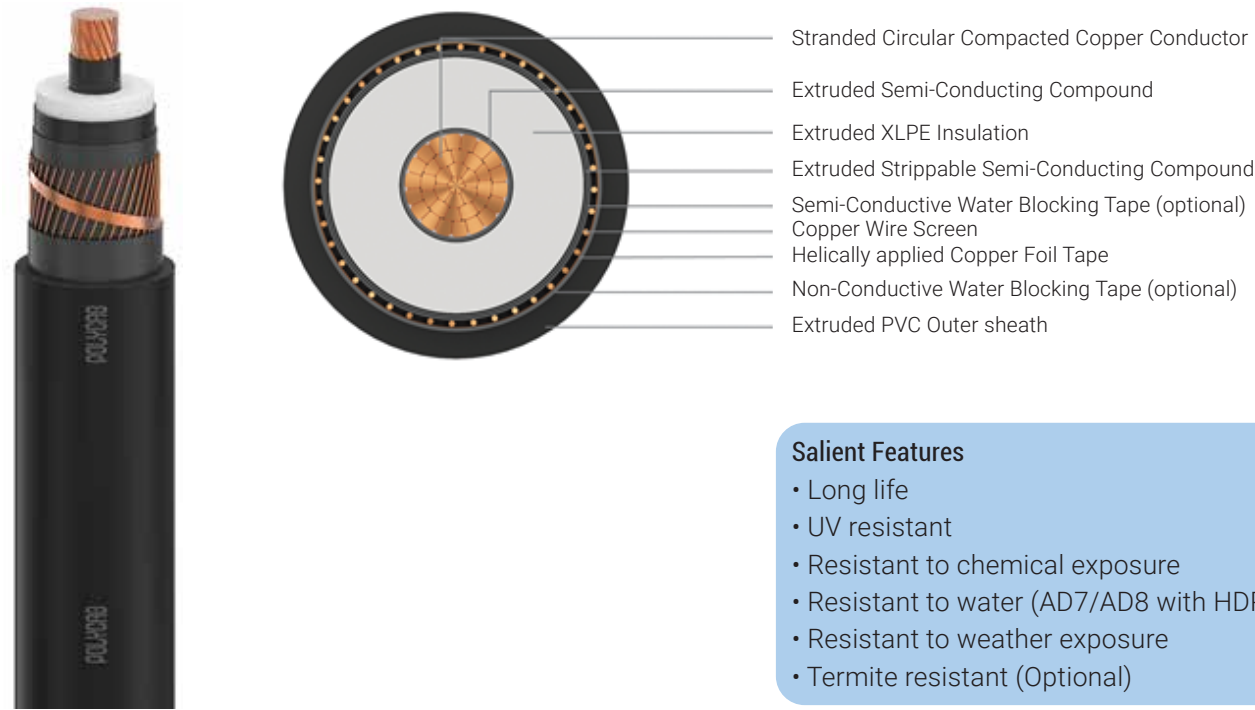

- Salient Features**
- Long life
 - UV resistant
 - Resistant to chemical exposure
 - Resistant to water (AD7/AD8 with HDPE)
 - Resistant to weather exposure
 - Termite resistant (Optional)

Application
POLYCAB MV 19/33 KV XLPE insulated with Copper conductor single core cable is suitable to use for power supply to wide networks i.e. Commercial, Industrial and Urban / Residential.

Voltage Rating
Nominal Voltage: 19/33 (36) kV

Operation Temperature
Min. installation temperature: 0°C
Operating temperature: -25°C to +90°C
Emergency operating temperature: 105°C
(max. operation of 36hrs, at 3 periods for 12 consecutive months use)
Max. Short Circuit Temperature: 250°C

- Construction**
- Conductor: Stranded Compacted Circular Copper conductor as per AS/NZS 1125
 - Conductor Screen: Extruded Semi-conductive compound
 - Insulation: XLPE
 - Insulation Screen: Extruded Strippable Semi-conductive compound
 - Longitudinal Water blocking : Water blocking tape above and below copper screen (Optional)
 - Metallic Insulation Screen: Copper Wire Screen + helicly applied copper tape (E/F current capacity – Based on requirement)
 - Metallic Sheath: Lead Alloy (optional)
 - Outer Sheath: Extruded Polyvinyl Chloride, Colour: Black
Termite Protection: Polyamide (Nylon -12) (optional)
(Alternative Sheath: PVC+HDPE Composite Sheath or PVC + Nylon + HDPE (composite sheath with anti-termite properties) or LSZH Outer sheath, and parameters will change accordingly)

Bending Radius: 20D
Fixed Installation: 12D (PVC) / 15D (HDPE) / 20D (Nylon)
During Installation: 18D (PVC) / 25D (HDPE) / 30D (Nylon)

D is overall diameter of cable

Standard and References:
AS/NZS 1429.1
AS/NZS 1125
AS/NZS 3808

High Voltage Test (kV AC)	Partial discharge test (kV AC)		Impulse test Voltage (kV peak)
	200% to rated voltage	150% to rated voltage	
63	38	29	200

- Compliance**
- Conductor resistance AS/NZS 1125
 - Insulation resistance AS/NZS 1429.1
 - Voltage test AS/NZS 1429.1



DIMENSIONAL CHARACTERISTICS:

Product Code	No. of Cores	Core Cross sectional Area	Nominal Diameter		
			Under metallic screen	Over metallic screen	Overall
	No.	mm ²	mm	mm	mm
MVNZ13CXUAPH001C050SAXXXX	1	50	27.2	29.1	33.0
MVNZ13CXUAPH001C070SAXXXX	1	70	28.9	30.8	35.0
MVNZ13CXUAPH001C095SAXXXX	1	95	30.4	32.3	37.0
MVNZ13CXUAPH001C120SAXXXX	1	120	32	33.9	38.0
MVNZ13CXUAPH001C150SAXXXX	1	150	33.4	35.3	40.0
MVNZ13CXUAPH001C185SAXXXX	1	185	35.1	37.0	42.0
MVNZ13CXUAPH001C240SAXXXX	1	240	37.4	39.3	44.0
MVNZ13CXUAPH001C300SAXXXX	1	300	39.4	41.3	46.0
MVNZ13CXUAPH001C400SAXXXX	1	400	42.2	44.1	49.0
MVNZ13CXUAPH001C500SAXXXX	1	500	45.6	47.5	53.0
MVNZ13CXUAPH001C630SAXXXX	1	630	49.2	51.1	57.0
MVNZ13CXUAPH001C800SAXXXX	1	800	52.9	54.8	61.0
MVNZ13CXUAPH001C01KSAXXXX	1	1000	57.2	59.1	65.0

- Above mentioned parameters are based on 3kA/sec earth fault current capacity of copper screen



POLYCAB SINGLE CORE MV AS/NZS 1429.1 19/33 (36) KV
MV Cable with Copper Conductor, XLPE Insulation, Copper Screen and Unarmoured

ELECTRICAL CHARACTERISTICS:

No. of Cores	Core Cross sectional Area	Max. DC Resistance at 20°C	Max. AC Resistance at 90°C	Approx. Capacitance	Approx. Inductance	Approx. Reactance	Continuous Current Rating					
							In ground at 20°C		In Duct at 20°C		In air at 30°C	
							Flat	Trefoil	Flat	Trefoil	Flat	Trefoil
No.	mm ²	Ω/km	Ω/km	μF/km	mH/km	Ω/km	Amps					
1	50	0.387	0.494	0.14	0.486	0.153	203	196	188	186	243	238
1	70	0.268	0.342	0.15	0.449	0.141	246	239	229	227	303	296
1	95	0.193	0.247	0.17	0.429	0.135	293	285	274	271	369	361
1	120	0.153	0.196	0.18	0.409	0.128	332	323	311	308	426	417
1	150	0.124	0.159	0.19	0.396	0.124	366	361	347	343	481	473
1	185	0.0991	0.127	0.21	0.382	0.120	410	406	391	387	550	543
1	240	0.0754	0.098	0.23	0.367	0.115	470	469	453	447	647	641
1	300	0.0601	0.079	0.25	0.354	0.111	524	526	510	504	739	735
1	400	0.047	0.063	0.27	0.341	0.107	572	590	571	564	837	845
1	500	0.0366	0.050	0.3	0.327	0.103	660	655	640	635	970	960
1	630	0.0283	0.041	0.33	0.316	0.099	735	730	715	710	1110	1100
1	800	0.0221	0.034	0.37	0.306	0.096	770	820	800	790	1260	1250
1	1000	0.0176	0.029	0.4	0.297	0.093	825	885	865	855	1420	1410

*: Current Ratings are based on IEC 60502-2 & IEC 60287, Max. Conductor Temperature at 90°C, Ambient temperature at 30°C in Air / at 20°C in Ground, Thermal resistivity of Soil 1.5 k.m/W & for earthenware ducts 1.2k.m/W and Depth of Laying 0.8m.

Current rating de-rating factors for other than 30°C ambient air temperature.

20	25	35	40	45	50	55	60
1.08	1.04	0.96	0.91	0.87	0.82	0.76	0.71

Current rating de-rating factors for other than 20°C ground temperature.

10	15	25	30	35	40	45	50
1.07	1.04	0.96	0.93	0.89	0.85	0.80	0.76

POLYCAB SINGLE CORE MV AS/NZS 1429.1 19/33 (36) KV
MV Cable with Copper Conductor, XLPE Insulation, Copper Screen and Unarmoured

No. of Cores	Core Cross sectional Area	Max. pulling tension on conductor	Charging Current per phase	Zero sequence impedance	Electric Stress at Conductor Screen	Short circuit rating of Phase conductor
No.	mm ²	kN	Amps/Km	Ohms/Km	kV/mm	kA, 1 sec
1	50	3.5	0.84	1.66	4.1	7.2
1	70	4.9	0.9	1.50	3.9	10.0
1	95	6.65	1.01	1.41	3.7	13.6
1	120	8.4	1.07	1.36	3.6	17.1
1	150	10.5	1.13	1.32	3.5	21.4
1	185	12.95	1.25	1.29	3.4	26.4
1	240	16.8	1.37	1.26	3.3	34.3
1	300	21	1.49	1.24	3.2	42.8
1	400	28	1.61	1.22	3.1	56.9
1	500	35	1.79	1.21	3.0	71.5
1	630	44.1	1.97	1.20	2.9	90.2
1	800	56	2.21	1.19	2.9	114
1	1000	70	2.39	1.19	2.8	143



OUR CERTIFICATION
 ISO 9001 | ISO 14001 | ISO 45001



OUR CERTIFICATION
 ISO 9001 | ISO 14001 | ISO 45001



POLYCAB SINGLE CORE MV AS/NZS 1429.1 19/33 (36) KV
MV Cable with Aluminium Conductor, XLPE Insulation, Copper Screen and Unarmoured

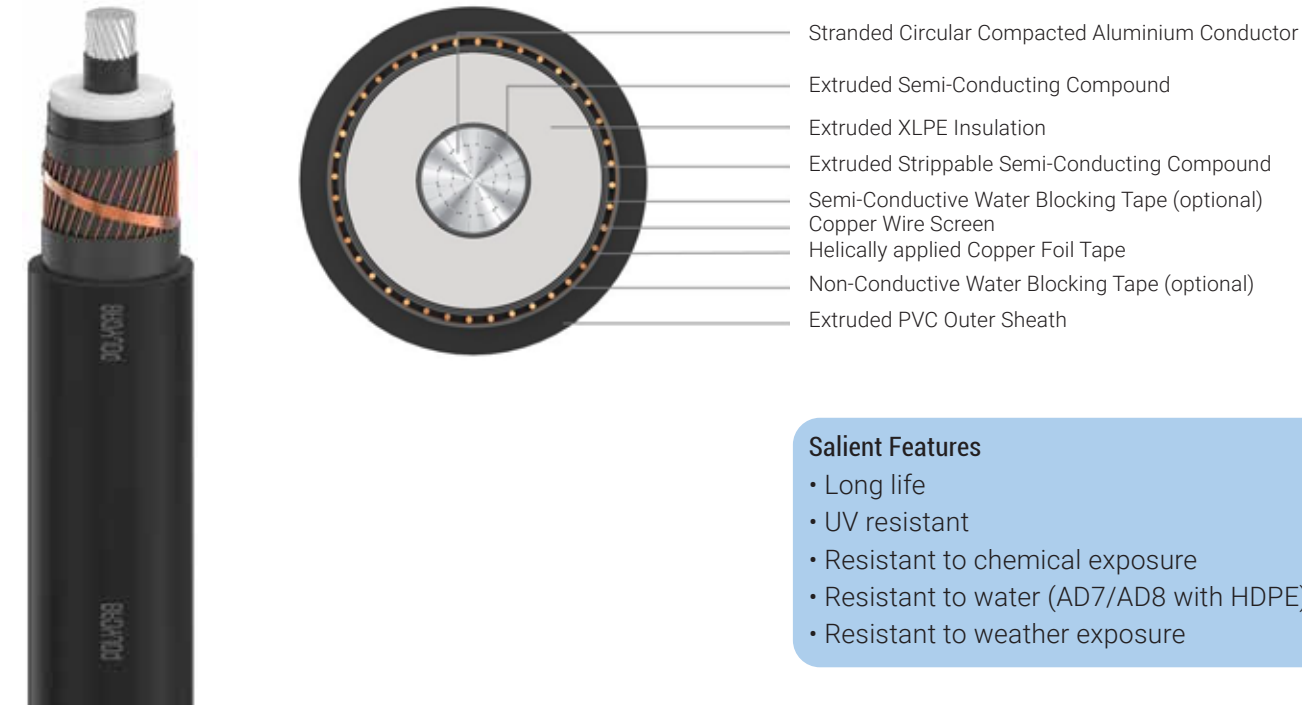

- Salient Features**
- Long life
 - UV resistant
 - Resistant to chemical exposure
 - Resistant to water (AD7/AD8 with HDPE)
 - Resistant to weather exposure

Application
POLYCAB MV 19/33 KV XLPE insulated with Aluminium conductor single core cable is suitable to use for power supply to wide networks i.e. Commercial, Industrial and Urban / Residential.

Voltage Rating
Nominal Voltage: 19/33 (36) kV

Operation Temperature
Min. installation temperature: 0°C
Operating temperature: -25°C to +90°C
Emergency operating temperature: 105°C
(max. operation of 36hrs, at 3 periods for 12 consecutive months use)
Max. Short Circuit Temperature: 250°C

- Construction**
- Conductor: Stranded Compacted Circular aluminium conductor as per AS/NZS 1125
 - Conductor Screen: Extruded Semi-conductive compound
 - Insulation: XLPE
 - Insulation Screen: Extruded strippable Semi-conductive compound
 - Longitudinal Water blocking : Water blocking tape above and below copper screen (Optional)
 - Metallic Insulation Screen: Copper Wire Screen + helicly applied copper tape (E/F current capacity – Based on requirement)
 - Metallic Sheath: Lead Alloy (optional)
 - Outer Sheath: Extruded Polyvinyl Chloride, Colour: Black
(Alternative Sheath: PVC+HDPE Composite Sheath or LSZH Outer sheath and parameters will change accordingly)

Bending Radius: 20D
Fixed Installation: 12D (PVC) / 15D (HDPE)
During Installation: 18D (PVC) / 25D (HDPE)

D is overall diameter of cable

Standard and References:
AS/NZS 1429.1
AS/NZS 1125
AS/NZS 3808

High Voltage Test (kV AC)	Partial discharge test (kV AC)		Impulse test Voltage (kV peak)
	200% to rated voltage	150% to rated voltage	
68	38	29	200

- Compliance**
- Conductor resistance AS/NZS 1125
 - Insulation resistance AS/NZS 1429.1
 - Voltage test AS/NZS 1429.1



POLYCAB SINGLE CORE MV AS/NZS 1429.1 19/33 (36) KV
MV Cable with Aluminium Conductor, XLPE Insulation, Copper Screen and Unarmoured

DIMENSIONAL CHARACTERISTICS:

Product Code	No. of Cores	Core Cross sectional Area	Nominal Diameter		
			Under metallic screen	Over metallic screen	Overall
	No.	mm ²	mm	mm	mm
MVNZ13AXUAPH001C050SAXXXX	1	50	27.2	29.1	33.0
MVNZ13AXUAPH001C070SAXXXX	1	70	28.8	30.7	35.0
MVNZ13AXUAPH001C095SAXXXX	1	95	30.4	32.3	37.0
MVNZ13AXUAPH001C120SAXXXX	1	120	32	33.9	38.0
MVNZ13AXUAPH001C150SAXXXX	1	150	33.3	35.2	40.0
MVNZ13AXUAPH001C185SAXXXX	1	185	35	36.9	42.0
MVNZ13AXUAPH001C240SAXXXX	1	240	37.3	39.2	44.0
MVNZ13AXUAPH001C300SAXXXX	1	300	39.5	41.4	46.0
MVNZ13AXUAPH001C400SAXXXX	1	400	42.2	44.1	49.0
MVNZ13AXUAPH001C500SAXXXX	1	500	45.6	47.5	53.0
MVNZ13AXUAPH001C630SAXXXX	1	630	48.8	50.7	56.0
MVNZ13AXUAPH001C800SAXXXX	1	800	52.7	54.6	60.0
MVNZ13AXUAPH001C01KSAXXXX	1	1000	57.2	59.1	65.0

- Above mentioned parameters are based on 3kA/sec earth fault current capacity of copper screen



POLYCAB SINGLE CORE MV AS/NZS 1429.1 19/33 (36) KV
MV Cable with Aluminium Conductor, XLPE Insulation, Copper Screen and Unarmoured

ELECTRICAL CHARACTERISTICS:

No. of Cores	Core Cross sectional Area	Max. DC Resistance at 20°C	Max. AC Resistance at 90°C	Approx. Capacitance	Approx. Inductance	Approx. Reactance	Continuous Current Rating					
							In ground at 20°C		In Duct at 20°C		In air at 30°C	
							Flat	Trefoil	Flat	Trefoil	Flat	Trefoil
No.	mm ²	Ω/km	Ω/km	μF/km	mH/km	Ω/km	Amps					
1	50	0.641	0.822	0.14	0.486	0.153	157	152	146	142	189	184
1	70	0.443	0.568	0.15	0.450	0.141	192	186	178	176	236	230
1	95	0.32	0.411	0.17	0.429	0.135	229	221	213	210	287	280
1	120	0.253	0.325	0.18	0.409	0.128	260	252	242	240	332	324
1	150	0.206	0.265	0.19	0.397	0.125	288	281	271	267	376	368
1	185	0.164	0.211	0.21	0.383	0.120	324	317	307	303	432	424
1	240	0.125	0.161	0.23	0.367	0.115	373	367	356	351	511	502
1	300	0.1	0.129	0.25	0.354	0.111	419	414	402	397	586	577
1	400	0.0778	0.101	0.27	0.341	0.107	466	470	457	451	676	673
1	500	0.0605	0.080	0.3	0.327	0.103	525	530	510	505	760	750
1	630	0.0469	0.063	0.33	0.317	0.100	580	585	560	555	860	850
1	800	0.0367	0.051	0.36	0.306	0.096	650	655	620	615	960	950
1	1000	0.0291	0.042	0.4	0.297	0.093	715	705	670	665	1060	1050

*: Current Ratings are based on IEC 60502-2 & IEC 60287, Max. Conductor Temperature at 90°C, Ambient temperature at 30°C in Air / at 20°C in Ground, Thermal resistivity of Soil 1.5 k.m/W & for earthenware ducts 1.2k.m/W and Depth of Laying 0.8m.

Current rating de-rating factors for other than 30°C ambient air temperature.

20	25	35	40	45	50	55	60
1.08	1.04	0.96	0.91	0.87	0.82	0.76	0.71

Current rating de-rating factors for other than 20°C ground temperature.

10	15	25	30	35	40	45	50
1.07	1.04	0.96	0.93	0.89	0.85	0.80	0.76

POLYCAB SINGLE CORE MV AS/NZS 1429.1 19/33 (36) KV
MV Cable with Aluminium Conductor, XLPE Insulation, Copper Screen and Unarmoured

No. of Cores	Core Cross sectional Area	Max. pulling tension on conductor	Charging Current per phase	Zero sequence impedance	Electric Stress at Conductor Screen	Short circuit rating of Phase conductor
No.	mm ²	kN	Amps/Km	Ohms/Km	kV/mm	kA, 1 sec
1	50	2.5	0.84	1.98	4.1	4.7
1	70	3.5	0.9	1.73	3.9	6.6
1	95	4.75	1.01	1.57	3.7	9.0
1	120	6	1.07	1.49	3.6	11.3
1	150	7.5	1.13	1.43	3.5	14.2
1	185	9.25	1.25	1.37	3.4	17.4
1	240	12	1.37	1.32	3.3	22.6
1	300	15	1.49	1.29	3.2	28.3
1	400	20	1.61	1.26	3.1	37.6
1	500	25	1.79	1.24	3.0	47.2
1	630	31.5	1.97	1.22	3.0	59.6
1	800	40	2.15	1.21	2.9	75.6
1	1000	50	2.39	1.20	2.8	94.5



OUR CERTIFICATION
ISO 9001 | ISO 14001 | ISO 45001



OUR CERTIFICATION
ISO 9001 | ISO 14001 | ISO 45001



POLYCAB SINGLE CORE ANTI-TERMITE MV AS/NZS 1429.1 19/33 (36) KV
MV Cable with Aluminium Conductor, XLPE Insulation, Copper Screen and Unarmoured

POLYCAB SINGLE CORE ANTI-TERMITE MV AS/NZS 1429.1 19/33 (36) KV
MV Cable with Aluminium Conductor, XLPE Insulation, Copper Screen and Unarmoured

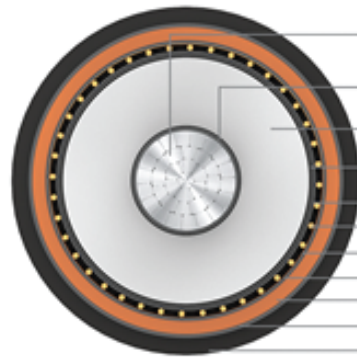

- Stranded Circular Compacted Aluminium Conductor
- Extruded Semi-Conducting Compound
- Extruded XLPE Insulation
- Extruded Strippable Semi-Conducting Compound
- Semi-Conductive Water Blocking Tape (optional)
- Copper Wire Screen
- Helically applied Copper Foil Tape
- Non-Conductive Water Blocking Tape (optional)
- Extruded PVC Inner layer
- Polyamide (Nylon-12) Anti-Termite layer
- Extruded HDPE outer sheath

Salient Features

- Long life
- UV resistant
- Resistant to chemical exposure
- Resistant to weather exposure
- Resistant to water (AD7/AD8)
- Termite resistant

Application
POLYCAB MV 19/33 KV XLPE insulated with Aluminium conductor single core cable is suitable to use for power supply to wide networks i.e. Commercial, Industrial and Urban / Residential.

Voltage Rating
Nominal Voltage: 19/33 (36) kV

Operation Temperature
Min. installation temperature: 0°C
Operating temperature: -25°C to +90°C
Emergency operating temperature: 105°C
(max. operation of 36hrs, at 3 periods for 12 consecutive months use)
Max. Short Circuit Temperature: 250°C

- Construction**
- Conductor: Stranded Compacted Circular aluminium conductor as per AS/NZS 1125
 - Conductor Screen: Extruded Semi-conductive compound
 - Insulation: XLPE
 - Insulation Screen: Extruded strippable Semi-conductive compound
 - Longitudinal Water blocking : Water blocking tape above and below copper screen (Optional)
 - Metallic Insulation Screen: Copper Wire Screen + helically applied copper tape (E/F current capacity – Based on requirement)
- Composite sheath**
- Inner layer: Extruded Polyvinyl Chloride, Colour: Orange
 - Termite Protection: Polyamide (Nylon -12)
 - Outer layer: HDPE (Black)

Bending Radius: 20D
Fixed Installation: 20D
During Installation: 30D

D is overall diameter of cable

Standard and References:
AS/NZS 1429.1
AS/NZS 1125
AS/NZS 3808

High Voltage Test (kV AC)	Partial discharge test (kV AC)		Impulse test Voltage (kV peak)
	200% to rated voltage	150% to rated voltage	
63	38	29	200

- Compliance**
- Conductor resistance AS/NZS 1125
 - Insulation resistance AS/NZS 1429.1
 - Voltage test AS/NZS 1429.1



DIMENSIONAL CHARACTERISTICS:

Product Code	No. of Cores	Core Cross sectional Area	Nominal Diameter		
			Under metallic screen	Over metallic screen	Overall
	No.	mm ²	mm	mm	mm
MVNZ54AXUAPH001C050SAXXXX	1	50	27.2	29.1	36.0
MVNZ54AXUAPH001C070SAXXXX	1	70	28.8	30.7	37.0
MVNZ54AXUAPH001C095SAXXXX	1	95	30.4	32.3	39.0
MVNZ54AXUAPH001C120SAXXXX	1	120	32	33.9	41.0
MVNZ54AXUAPH001C150SAXXXX	1	150	33.3	35.2	42.0
MVNZ54AXUAPH001C185SAXXXX	1	185	35	36.9	44.0
MVNZ54AXUAPH001C240SAXXXX	1	240	37.3	39.2	46.0
MVNZ54AXUAPH001C300SAXXXX	1	300	39.5	41.4	49.0
MVNZ54AXUAPH001C400SAXXXX	1	400	42.2	44.1	52.0
MVNZ54AXUAPH001C500SAXXXX	1	500	45.6	47.5	55.0
MVNZ54AXUAPH001C630SAXXXX	1	630	48.8	50.7	59.0
MVNZ54AXUAPH001C800SAXXXX	1	800	52.7	54.6	63.0
MVNZ54AXUAPH001C01KSAXXXX	1	1000	57.2	59.1	68.0

- Above mentioned parameters are based on 3kA/sec earth fault current capacity of copper screen



POLYCAB SINGLE CORE ANTI-TERMITE MV AS/NZS 1429.1 19/33 (36) KV
MV Cable with Aluminium Conductor, XLPE Insulation, Copper Screen and Unarmoured

ELECTRICAL CHARACTERISTICS:

No. of Cores	Core Cross sectional Area	Max. DC Resistance at 20°C	Max. AC Resistance at 90°C	Approx. Capacitance	Approx. Inductance	Approx. Reactance	Continuous Current Rating					
							In ground at 20°C		In Duct at 20°C		In air at 30°C	
							Flat	Trefoil	Flat	Trefoil	Flat	Trefoil
No.	mm ²	Ω/km	Ω/km	μF/km	mH/km	Ω/km	Amps					
1	50	0.641	0.822	0.14	0.500	0.157	157	152	146	142	189	184
1	70	0.443	0.568	0.15	0.464	0.146	192	186	178	176	236	230
1	95	0.32	0.411	0.17	0.443	0.139	229	221	213	210	287	280
1	120	0.253	0.325	0.18	0.422	0.132	260	252	242	240	332	324
1	150	0.206	0.265	0.19	0.409	0.128	288	281	271	267	376	368
1	185	0.164	0.211	0.21	0.394	0.124	324	317	307	303	432	424
1	240	0.125	0.161	0.23	0.377	0.118	373	367	356	351	511	502
1	300	0.1	0.129	0.25	0.363	0.114	419	414	402	397	586	577
1	400	0.0778	0.101	0.27	0.350	0.110	466	470	457	451	676	673
1	500	0.0605	0.080	0.3	0.337	0.106	525	530	510	505	760	750
1	630	0.0469	0.063	0.33	0.326	0.102	580	585	560	555	860	850
1	800	0.0367	0.051	0.36	0.315	0.099	650	655	620	615	960	950
1	1000	0.0291	0.042	0.4	0.306	0.096	715	705	670	665	1060	1050

*: Current Ratings are based on IEC 60502-2 & IEC 60287, Max. Conductor Temperature at 90°C, Ambient temperature at 30°C in Air / at 20°C in Ground, Thermal resistivity of Soil 1.5 k.m/W & for earthenware ducts 1.2k.m/W and Depth of Laying 0.8m.

Current rating de-rating factors for other than 30°C ambient air temperature.

20	25	35	40	45	50	55	60
1.08	1.04	0.96	0.91	0.87	0.82	0.76	0.71

Current rating de-rating factors for other than 20°C ground temperature.

10	15	25	30	35	40	45	50
1.07	1.04	0.96	0.93	0.89	0.85	0.80	0.76

POLYCAB SINGLE CORE ANTI-TERMITE MV AS/NZS 1429.1 19/33 (36) KV
MV Cable with Aluminium Conductor, XLPE Insulation, Copper Screen and Unarmoured

No. of Cores	Core Cross sectional Area	Max. pulling tension on conductor	Charging Current per phase	Zero sequence impedance	Electric Stress at Conductor Screen	Short circuit rating of Phase conductor
No.	mm ²	kN	Amps/Km	Ohms/Km	kV/mm	kA, 1 sec
1	50	2.5	0.84	1.98	4.1	4.7
1	70	3.5	0.9	1.73	3.9	6.6
1	95	4.75	1.01	1.57	3.7	9.0
1	120	6	1.07	1.49	3.6	11.3
1	150	7.5	1.13	1.43	3.5	14.2
1	185	9.25	1.25	1.37	3.4	17.4
1	240	12	1.37	1.32	3.3	22.6
1	300	15	1.49	1.29	3.2	28.3
1	400	20	1.61	1.26	3.1	37.6
1	500	25	1.79	1.24	3.0	47.2
1	630	31.5	1.97	1.22	3.0	59.6
1	800	40	2.15	1.21	2.9	75.6
1	1000	50	2.39	1.20	2.8	94.5



OUR CERTIFICATION
 ISO 9001 | ISO 14001 | ISO 45001



OUR CERTIFICATION
 ISO 9001 | ISO 14001 | ISO 45001



POLYCAB THREE CORE MV AS/NZS 1429.1 1.9/3.3 (3.6) KV
MV Cable with Copper Conductor, XLPE Insulation, Copper Screen and Unarmoured

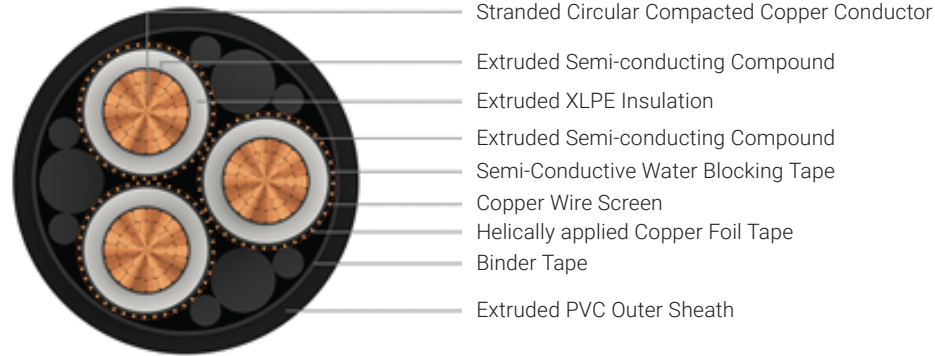

- Salient Features**
- Long life
 - UV resistant
 - Resistant to chemical exposure
 - Resistant to water (AD7/AD8 with HDPE)
 - Resistant to weather exposure
 - Termite resistant (Optional)

Application
POLYCAB MV 1.9/3.3 KV XLPE insulated with Copper conductor Three core cable is suitable to use for power supply to wide networks i.e. Commercial, Industrial and Urban / Residential.

Voltage Rating
Nominal Voltage: 1.9/3.3 (3.6) kV

Operation Temperature
Min. installation temperature: 0°C
Operating temperature: -25°C to +90°C
Emergency operating temperature: 105°C
(max. operation of 36hrs, at 3 periods for 12 consecutive months use)
Max. Short Circuit Temperature: 250°C

- Construction**
- Conductor: Stranded Compacted Circular Copper conductor as per AS/NZS 1125
 - Conductor Screen: Extruded Semi-conductive compound
 - Insulation: XLPE
 - Insulation Screen: Extruded Semi-conductive compound
 - Longitudinal Water blocking : Water blocking tape below copper screen (Optional)
 - Metallic Insulation Screen: Copper Wire Screen + helically applied copper tape (E/F current capacity – Based on requirement)
 - binder tape / sheath over assembled cores
 - Metallic Sheath: Lead Alloy (optional)
 - Outer Sheath: Extruded Polyvinyl Chloride, Colour: Black
 - Insect attack Protection: Polyamide Nylon (optional)
(Alternative Sheath: PVC+HDPE Composite Sheath or PVC + Nylon + HDPE (composite sheath with anti-termite properties) or LSZH Outer sheath, and parameters will change accordingly)

Bending Radius: 20D
Fixed Installation: 12D (PVC) / 15D (HDPE) / 20D (Nylon)
During Installation: 18D (PVC) / 25D (HDPE) / 30D (Nylon)

D is overall diameter of cable

Standard and References:
AS/NZS 1429.1
AS/NZS 1125
AS/NZS 3808

High Voltage Test
6.5 kV AC

- Compliance**
- Conductor resistance AS/NZS 1125
 - Insulation resistance AS/NZS 1429.1
 - Voltage test AS/NZS 1429.1



POLYCAB THREE CORE MV AS/NZS 1429.1 1.9/3.3 (3.6) KV
MV Cable with Copper Conductor, XLPE Insulation, Copper Screen and Unarmoured

DIMENSIONAL CHARACTERISTICS:



Product Code	No. of Cores	Core Cross sectional Area	Nominal Diameter		
			Under metallic screen	Over metallic screen	Overall
	No.	mm ²	mm	mm	mm
MVNZ10CXUAPH003C016SAXXXX	3	16	11.9	13.4	33.0
MVNZ10CXUAPH003C025SAXXXX	3	25	13.1	14.6	35.0
MVNZ10CXUAPH003C035SAXXXX	3	35	14.1	15.6	38.0
MVNZ10CXUAPH003C050SAXXXX	3	50	15.2	16.7	40.0
MVNZ10CXUAPH003C070SAXXXX	3	70	16.9	18.4	44.0
MVNZ10CXUAPH003C095SAXXXX	3	95	18.4	19.9	48.0
MVNZ10CXUAPH003C120SAXXXX	3	120	20	21.5	51.0
MVNZ10CXUAPH003C150SAXXXX	3	150	21.4	22.9	55.0
MVNZ10CXUAPH003C185SAXXXX	3	185	23.1	24.6	58.0
MVNZ10CXUAPH003C240SAXXXX	3	240	25.4	26.9	64.0
MVNZ10CXUAPH003C300SAXXXX	3	300	27.4	28.9	68.0
MVNZ10CXUAPH003C400SAXXXX	3	400	30.2	31.7	75.0
MVNZ10CXUAPH003C500SAXXXX	3	500	34	35.5	83.0

- Above mentioned parameters are based on 3kA/sec earth fault current capacity of copper screen



POLYCAB THREE CORE MV AS/NZS 1429.1 1.9/3.3 (3.6) KV
MV Cable with Copper Conductor, XLPE Insulation, Copper Screen and Unarmoured

ELECTRICAL CHARACTERISTICS:

No. of Cores	Core Cross sectional Area	Max. DC Resistance at 20°C	Max. AC Resistance at 90°C	Approx. Capacitance	Approx. Inductance	Approx. Reactance	Continuous Current Rating		
							Buried direct in ground	In a buried duct	In Air
									
No.	mm ²	Ω/km	Ω/km	μF/km	mH/km	Ω/km	Amps		
3	16	1.15	1.466	0.26	0.600	0.189	101	87	109
3	25	0.727	0.927	0.3	0.569	0.179	129	112	142
3	35	0.524	0.668	0.34	0.551	0.173	153	133	170
3	50	0.387	0.494	0.38	0.534	0.168	181	158	204
3	70	0.268	0.342	0.44	0.505	0.159	221	193	253
3	95	0.193	0.247	0.49	0.492	0.154	262	231	304
3	120	0.153	0.196	0.55	0.477	0.150	298	264	351
3	150	0.124	0.159	0.59	0.468	0.147	334	297	398
3	185	0.0991	0.127	0.65	0.459	0.144	377	336	455
3	240	0.0754	0.097	0.73	0.450	0.141	434	390	531
3	300	0.0601	0.078	0.8	0.441	0.139	489	441	606
3	400	0.047	0.062	0.9	0.433	0.136	553	501	696
3	500	0.0366	0.049	0.93	0.427	0.134	632	574	800

*: Current Ratings are based on IEC 60502-2 & IEC 60287, Max. Conductor Temperature at 90°C, Ambient temperature at 30°C in Air / at 20°C in Ground, Thermal resistivity of Soil 1.5 k.m/W & for earthenware ducts 1.2k.m/W and Depth of Laying 0.8m.

Current rating de-rating factors for other than 30°C ambient air temperature.

20	25	35	40	45	50	55	60
1.08	1.04	0.96	0.91	0.87	0.82	0.76	0.71

Current rating de-rating factors for other than 20°C ground temperature.

10	15	25	30	35	40	45	50
1.07	1.04	0.96	0.93	0.89	0.85	0.80	0.76

POLYCAB THREE CORE MV AS/NZS 1429.1 1.9/3.3 (3.6) KV
MV Cable with Copper Conductor, XLPE Insulation, Copper Screen and Unarmoured

No. of Cores	Core Cross sectional Area	Max. pulling tension on conductor	Charging Current per phase	Zero sequence impedance	Electric Stress at Conductor Screen	Short circuit rating of Phase conductor
No.	mm ²	kN	Amps/Km	Ohms/Km	kV/mm	kA, 1 sec
3	16	1.12	0.16	2.63	1.3	2.3
3	25	1.75	0.18	2.09	1.2	3.6
3	35	2.45	0.2	1.83	1.2	5.0
3	50	3.5	0.23	1.65	1.1	7.2
3	70	4.9	0.26	1.50	1.1	10.0
3	95	6.65	0.29	1.41	1.1	13.6
3	120	8.4	0.33	1.36	1.1	17.1
3	150	10.5	0.35	1.32	1.1	21.4
3	185	12.95	0.39	1.29	1.1	26.4
3	240	16.8	0.44	1.26	1.0	34.3
3	300	21	0.48	1.24	1.0	42.8
3	400	28	0.54	1.22	1.0	56.9
3	500	35	0.56	1.21	0.9	71.5



OUR CERTIFICATION
 ISO 9001 | ISO 14001 | ISO 45001



OUR CERTIFICATION
 ISO 9001 | ISO 14001 | ISO 45001



POLYCAB THREE CORE MV AS/NZS 1429.1 1.9/3.3 (3.6) KV
MV Cable with Aluminium Conductor, XLPE Insulation, Copper Screen and Unarmoured

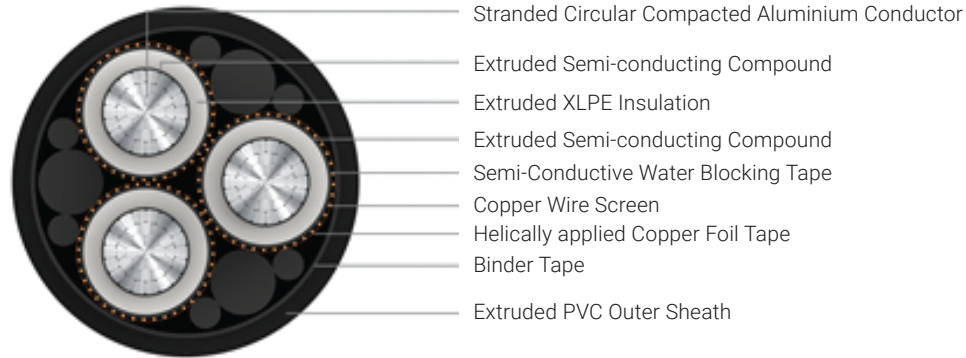

Salient Features

- Long life
- UV resistant
- Resistant to chemical exposure
- Resistant to water (AD7/AD8 with HDPE)
- Resistant to weather exposure

Application

POLYCAB MV 1.9/3.3 KV XLPE insulated with Aluminium conductor Three core cable is suitable to use for power supply to wide networks i.e. Commercial, Industrial and Urban / Residential.

Voltage Rating

Nominal Voltage: 1.9/3.3 (3.6) kV

Operation Temperature

Min. installation temperature: 0°C
 Operating temperature: -25°C to +90°C
 Emergency operating temperature: 105°C
 (max. operation of 36hrs, at 3 periods for 12 consecutive months use)
 Max. Short Circuit Temperature: 250°C

Construction

- Conductor: Stranded Compacted Circular aluminium conductor as per AS/NZS 1125
- Conductor Screen: Extruded Semi-conductive compound
- Insulation: XLPE
- Insulation Screen: Extruded Semi-conductive compound
- Longitudinal Water blocking : Water blocking tape above and below copper screen (Optional)
- Metallic Insulation Screen: Copper Wire Screen + helically applied copper tape
- binder tape / sheath over assembled cores
- Metallic Sheath: Lead Alloy (optional)
- Outer Sheath: Extruded Polyvinyl Chloride, Colour: Black
- Insect attack Protection: Polyamide Nylon (optional)
 (Alternative Sheath: PVC + HDPE Outer Sheath or LSZH Outer sheath and parameters will change accordingly)

Bending Radius:

Fixed Installation: 12D (PVC) / 15D (HDPE)
 During Installation: 18D (PVC) / 25D (HDPE)

D is overall diameter of cable

Standard and References:

AS/NZS 1429.1
 AS/NZS 1125
 AS/NZS 3808

High Voltage Test

6.5 kV AC

Compliance

- Conductor resistance AS/NZS 1125
- Insulation resistance AS/NZS 1429.1
- Voltage test AS/NZS 1429.1



POLYCAB THREE CORE MV AS/NZS 1429.1 1.9/3.3 (3.6) KV
MV Cable with Aluminium Conductor, XLPE Insulation, Copper Screen and Unarmoured

DIMENSIONAL CHARACTERISTICS:

Product Code	No. of Cores	Core Cross sectional Area	Nominal Diameter		
			Under metallic screen	Over metallic screen	Overall
	No.	mm ²	mm	mm	mm
MVNZ10AXUAPH003C016SAXXXX	3	16	11.8	13.3	33.0
MVNZ10AXUAPH003C025SAXXXX	3	25	13.1	14.6	35.0
MVNZ10AXUAPH003C035SAXXXX	3	35	14.1	15.6	38.0
MVNZ10AXUAPH003C050SAXXXX	3	50	15.2	16.7	40.0
MVNZ10AXUAPH003C070SAXXXX	3	70	16.8	18.3	44.0
MVNZ10AXUAPH003C095SAXXXX	3	95	18.4	19.9	48.0
MVNZ10AXUAPH003C120SAXXXX	3	120	20	21.5	51.0
MVNZ10AXUAPH003C150SAXXXX	3	150	21.3	22.8	54.0
MVNZ10AXUAPH003C185SAXXXX	3	185	23	24.5	58.0
MVNZ10AXUAPH003C240SAXXXX	3	240	25.3	26.8	64.0
MVNZ10AXUAPH003C300SAXXXX	3	300	27.5	29.0	69.0
MVNZ10AXUAPH003C400SAXXXX	3	400	30.2	31.7	75.0
MVNZ10AXUAPH003C500SAXXXX	3	500	34	35.5	83.0

- Above mentioned parameters are based on 3kA/sec earth fault current capacity of copper screen



OUR CERTIFICATION
 ISO 9001 | ISO 14001 | ISO 45001





OUR CERTIFICATION
 ISO 9001 | ISO 14001 | ISO 45001



POLYCAB THREE CORE MV AS/NZS 1429.1 1.9/3.3 (3.6) KV
MV Cable with Aluminium Conductor, XLPE Insulation, Copper Screen and Unarmoured

ELECTRICAL CHARACTERISTICS:

No. of Cores	Core Cross sectional Area	Max. DC Resistance at 20°C	Max. AC Resistance at 90°C	Approx. Capacitance	Approx. Inductance	Approx. Reactance	Continuous Current Rating		
							Buried direct in ground	In a buried duct	In Air
									
No.	mm ²	Ω/km	Ω/km	μF/km	mH/km	Ω/km	Amps		
3	16	1.91	2.449	0.26	0.603	0.189	78	67	84
3	25	1.2	1.539	0.3	0.569	0.179	100	87	110
3	35	0.868	1.113	0.34	0.551	0.173	119	103	132
3	50	0.641	0.822	0.38	0.534	0.168	140	122	158
3	70	0.443	0.568	0.43	0.506	0.159	171	150	196
3	95	0.32	0.411	0.49	0.492	0.154	203	179	236
3	120	0.253	0.325	0.55	0.477	0.150	232	205	273
3	150	0.206	0.265	0.59	0.469	0.147	260	231	309
3	185	0.164	0.211	0.65	0.460	0.144	294	262	355
3	240	0.125	0.161	0.73	0.450	0.141	340	305	415
3	300	0.1	0.129	0.81	0.441	0.138	384	346	475
3	400	0.0778	0.101	0.9	0.433	0.136	438	398	552
3	500	0.0605	0.079	0.93	0.427	0.134	505	460	646

: Current ratings are in accordance with IEC 60502-2: Current Ratings are based on IEC 60502-2 & IEC 60287, Max. Conductor Temperature at 90°C, Ambient temperature at 30°C in Air / at 20°C in Ground, Thermal resistivity of Soil 1.5 k.m/W & for earthenware ducts 1.2k.m/W and Depth of Laying 0.8m.

Current rating de-rating factors for other than 30°C ambient air temperature.

20	25	35	40	45	50	55	60
1.08	1.04	0.96	0.91	0.87	0.82	0.76	0.71

Current rating de-rating factors for other than 20°C ground temperature.

10	15	25	30	35	40	45	50
1.07	1.04	0.96	0.93	0.89	0.85	0.80	0.76

POLYCAB THREE CORE MV AS/NZS 1429.1 1.9/3.3 (3.6) KV
MV Cable with Aluminium Conductor, XLPE Insulation, Copper Screen and Unarmoured

No. of Cores	Core Cross sectional Area	Max. pulling tension on conductor	Charging Current per phase	Zero sequence impedance	Electric Stress at Conductor Screen	Short circuit rating of Phase conductor
No.	mm ²	kN	Amps/Km	Ohms/Km	kV/mm	kA, 1 sec
3	16	0.8	0.16	3.61	1.3	1.4
3	25	1.25	0.18	2.70	1.2	2.3
3	35	1.75	0.2	2.27	1.2	3.1
3	50	2.5	0.23	1.98	1.1	4.5
3	70	3.5	0.26	1.73	1.1	6.2
3	95	4.75	0.29	1.57	1.1	8.5
3	120	6	0.33	1.48	1.1	10.7
3	150	7.5	0.35	1.42	1.1	13.4
3	185	9.25	0.39	1.37	1.1	16.5
3	240	12	0.44	1.32	1.0	21.4
3	300	15	0.48	1.29	1.0	26.8
3	400	20	0.54	1.26	1.0	35.5
3	500	25	0.56	1.24	0.9	44.7



OUR CERTIFICATION
 ISO 9001 | ISO 14001 | ISO 45001



OUR CERTIFICATION
 ISO 9001 | ISO 14001 | ISO 45001



POLYCAB THREE CORE ANTI-TERMITE MV AS/NZS 1429.1 1.9/3.3 (3.6)
MV Cable with Aluminium Conductor, XLPE Insulation, Copper Screen and Unarmoured



- Stranded Circular Compacted Aluminium Conductor
- Extruded Semi-conducting Compound
- Extruded XLPE Insulation
- Extruded Semi-conducting Compound
- Semi-Conductive Water Blocking Tape (optional)
- Copper Wire Screen
- Helically applied Copper Foil Tape
- Binder Tape
- Extruded PVC Inner layer
- Polyamide (Nylon-12) Anti-Termite layer
- Extruded HDPE Outer Sheath

Salient Features

- Long life
- UV resistant
- Resistant to chemical exposure
- Resistant to weather exposure
- Resistant to water (AD7/AD8)
- Termite resistant

Application

POLYCAB MV 1.9/3.3 KV XLPE insulated with Aluminium conductor Three core cable is suitable to use for power supply to wide networks i.e. Commercial, Industrial and Urban / Residential.

Voltage Rating

Nominal Voltage: 1.9/3.3 (3.6) kV

Operation Temperature

Min. installation temperature: 0°C
 Operating temperature: -25°C to +90°C
 Emergency operating temperature: 105°C
 (max. operation of 36hrs, at 3 periods for 12 consecutive months use)
 Max. Short Circuit Temperature: 250°C

Construction

- Conductor: Stranded Compacted Circular aluminium conductor as per AS/NZS 1125
 - Conductor Screen: Extruded Semi-conductive compound
 - Insulation: XLPE
 - Insulation Screen: Extruded Semi-conductive compound
 - Longitudinal Water blocking : Water blocking tape above and below copper screen (Optional)
 - Metallic Insulation Screen: Copper Wire Screen + helically applied copper tape
 - binder tape / sheath over assembled cores
- Composite sheath**
- Inner layer : Extruded Polyvinyl Chloride, Colour: Orange
 - Termite Protection: Polyamide (Nylon -12)
 - Outer layer: HDPE (Black)

Bending Radius:

Fixed Installation: 20D
 During Installation: 30D

D is overall diameter of cable

Standard and References:

AS/NZS 1429.1
 AS/NZS 1125
 AS/NZS 3808

High Voltage Test

6.5 kV AC

Compliance

- Conductor resistance AS/NZS 1125
- Insulation resistance AS/NZS 1429.1
- Voltage test AS/NZS 1429.1



POLYCAB THREE CORE ANTI-TERMITE MV AS/NZS 1429.1 1.9/3.3 (3.6)
MV Cable with Aluminium Conductor, XLPE Insulation, Copper Screen and Unarmoured

DIMENSIONAL CHARACTERISTICS:



Product Code	No. of Cores	Core Cross sectional Area	Nominal Diameter		
			Under metallic screen	Over metallic screen	Overall
	No.	mm ²	mm	mm	mm
MVNZ10AXUAPH003C016SAXXXX	3	16	11.8	13.3	33.0
MVNZ10AXUAPH003C025SAXXXX	3	25	13.1	14.6	36.0
MVNZ10AXUAPH003C035SAXXXX	3	35	14.1	15.6	38.0
MVNZ10AXUAPH003C050SAXXXX	3	50	15.2	16.7	41.0
MVNZ10AXUAPH003C070SAXXXX	3	70	16.8	18.3	44.0
MVNZ10AXUAPH003C095SAXXXX	3	95	18.4	19.9	48.0
MVNZ10AXUAPH003C120SAXXXX	3	120	20	21.5	52.0
MVNZ10AXUAPH003C150SAXXXX	3	150	21.3	22.8	55.0
MVNZ10AXUAPH003C185SAXXXX	3	185	23	24.5	59.0
MVNZ10AXUAPH003C240SAXXXX	3	240	25.3	26.8	64.0
MVNZ10AXUAPH003C300SAXXXX	3	300	27.5	29.0	69.0
MVNZ10AXUAPH003C400SAXXXX	3	400	30.2	31.7	75.0
MVNZ10AXUAPH003C500SAXXXX	3	500	34	35.5	84.0

- Above mentioned parameters are based on 3kA/sec earth fault current capacity of copper screen

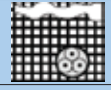

POLYCAB THREE CORE ANTI-TERMITE MV AS/NZS 1429.1 1.9/3.3 (3.6)
MV Cable with Aluminium Conductor, XLPE Insulation, Copper Screen and Unarmoured

ELECTRICAL CHARACTERISTICS:

No. of Cores	Core Cross sectional Area	Max. DC Resistance at 20°C	Max. AC Resistance at 90°C	Approx. Capacitance	Approx. Inductance	Approx. Reactance	Continuous Current Rating		
							Buried direct in ground	In a buried duct	In Air
									
No.	mm ²	Ω/km	Ω/km	μF/km	mH/km	Ω/km	Amps		
3	16	1.91	2.449	0.26	0.605	0.190	78	67	84
3	25	1.2	1.539	0.3	0.571	0.180	100	87	110
3	35	0.868	1.113	0.34	0.553	0.174	119	103	132
3	50	0.641	0.822	0.38	0.536	0.168	140	122	158
3	70	0.443	0.568	0.43	0.507	0.159	171	150	196
3	95	0.32	0.411	0.49	0.493	0.155	203	179	236
3	120	0.253	0.325	0.55	0.478	0.150	232	205	273
3	150	0.206	0.265	0.59	0.470	0.148	260	231	309
3	185	0.164	0.211	0.65	0.461	0.145	294	262	355
3	240	0.125	0.161	0.73	0.451	0.142	340	305	415
3	300	0.1	0.129	0.81	0.442	0.139	384	346	475
3	400	0.0778	0.101	0.9	0.434	0.136	438	398	552
3	500	0.0605	0.079	0.93	0.428	0.135	505	460	646

: Current ratings are in accordance with IEC 60502-2: Current Ratings are based on IEC 60502-2 & IEC 60287, Max. Conductor Temperature at 90°C, Ambient temperature at 30°C in Air / at 20°C in Ground, Thermal resistivity of Soil 1.5 k.m/W & for earthenware ducts 1.2k.m/W and Depth of Laying 0.8m.

Current rating de-rating factors for other than 30°C ambient air temperature.

20	25	35	40	45	50	55	60
1.08	1.04	0.96	0.91	0.87	0.82	0.76	0.71

Current rating de-rating factors for other than 20°C ground temperature.

10	15	25	30	35	40	45	50
1.07	1.04	0.96	0.93	0.89	0.85	0.80	0.76

POLYCAB THREE CORE ANTI-TERMITE MV AS/NZS 1429.1 1.9/3.3 (3.6)
MV Cable with Aluminium Conductor, XLPE Insulation, Copper Screen and Unarmoured

No. of Cores	Core Cross sectional Area	Max. pulling tension on conductor	Charging Current per phase	Zero sequence impedance	Electric Stress at Conductor Screen	Short circuit rating of Phase conductor
No.	mm ²	kN	Amps/Km	Ohms/Km	kV/mm	kA, 1 sec
3	16	0.8	0.16	3.61	1.3	1.4
3	25	1.25	0.18	2.70	1.2	2.3
3	35	1.75	0.2	2.27	1.2	3.1
3	50	2.5	0.23	1.98	1.1	4.5
3	70	3.5	0.26	1.73	1.1	6.2
3	95	4.75	0.29	1.57	1.1	8.5
3	120	6	0.33	1.48	1.1	10.7
3	150	7.5	0.35	1.42	1.1	13.4
3	185	9.25	0.39	1.37	1.1	16.5
3	240	12	0.44	1.32	1.0	21.4
3	300	15	0.48	1.29	1.0	26.8
3	400	20	0.54	1.26	1.0	35.5
3	500	25	0.56	1.24	0.9	44.7



OUR CERTIFICATION
ISO 9001 | ISO 14001 | ISO 45001



OUR CERTIFICATION
ISO 9001 | ISO 14001 | ISO 45001



POLYCAB THREE CORE MV AS/NZS 1429.1 3.8/6.6 (7.2) KV
MV Cable with Copper Conductor, XLPE Insulation, Copper Screen and Unarmoured

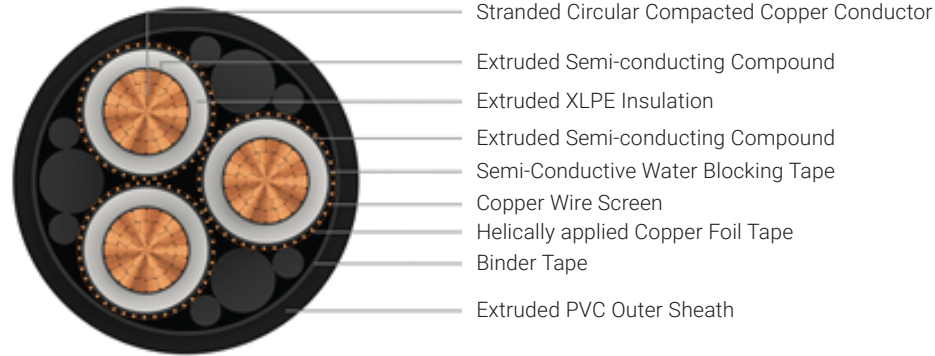

- Salient Features**
- Long life
 - UV resistant
 - Resistant to chemical exposure
 - Resistant to water (AD7/AD8 with HDPE)
 - Resistant to weather exposure
 - Termite resistant (Optional)

Application
POLYCAB MV 3.8/6.6 KV XLPE insulated with Copper conductor Three core cable is suitable to use for power supply to wide networks i.e. Commercial, Industrial and Urban / Residential.

Voltage Rating
Nominal Voltage: 3.8/6.6 (7.2) kV

Operation Temperature
Min. installation temperature: 0°C
Operating temperature: -25°C to +90°C
Emergency operating temperature: 105°C
(max. operation of 36hrs, at 3 periods for 12 consecutive months use)
Max. Short Circuit Temperature: 250°C

- Construction**
- Conductor: Stranded Compacted Circular Copper conductor as per AS/NZS 1125
 - Conductor Screen: Extruded Semi-conductive compound
 - Insulation: XLPE
 - Insulation Screen: Extruded Semi-conductive compound
 - Longitudinal Water blocking : Water blocking tape below copper screen (Optional)
 - Metallic Insulation Screen: Copper Wire Screen + helically applied copper tape (E/F current capacity – Based on requirement)
 - binder tape / sheath over assembled cores
 - Metallic Sheath: Lead Alloy (optional)
 - Outer Sheath: Extruded Polyvinyl Chloride, Colour: Black
 - Insect attack Protection: Polyamide Nylon (optional)
(Alternative Sheath: PVC+HDPE Composite Sheath or PVC + Nylon + HDPE (composite sheath with anti-termite properties) or LSZH Outer sheath, and parameters will change accordingly)

Bending Radius:
Fixed Installation: 12D (PVC) / 15D (HDPE) / 20D (Nylon)
During Installation: 18D (PVC) / 25D (HDPE) / 30D (Nylon)

D is overall diameter of cable

Standard and References:
AS/NZS 1429.1
AS/NZS 1125
AS/NZS 3808

High Voltage Test (kV AC)	Partial discharge test (kV AC)		Impulse test Voltage (kV peak)
	200% to rated voltage	150% to rated voltage	
12.5	7.6	5.7	60

- Compliance**
- Conductor resistance AS/NZS 1125
 - Insulation resistance AS/NZS 1429.1
 - Voltage test AS/NZS 1429.1



SPOLYCAB THREE CORE MV AS/NZS 1429.1 3.8/6.6 (7.2) KV
MV Cable with Copper Conductor, XLPE Insulation, Copper Screen and Unarmoured

DIMENSIONAL CHARACTERISTICS:



Product Code	No. of Cores	Core Cross sectional Area	Nominal Diameter		
			Under metallic screen	Over metallic screen	Overall
	No.	mm ²	mm	mm	mm
MVNZ15CXSWPH003C016SAXXXX	3	16	12.9	14.4	35.0
MVNZ15CXSWPH003C025SAXXXX	3	25	14.1	15.6	38.0
MVNZ15CXSWPH003C035SAXXXX	3	35	15.1	16.6	40.0
MVNZ15CXSWPH003C050SAXXXX	3	50	16.2	17.7	43.0
MVNZ15CXSWPH003C070SAXXXX	3	70	17.9	19.4	46.0
MVNZ15CXSWPH003C095SAXXXX	3	95	19.4	20.9	50.0
MVNZ15CXSWPH003C120SAXXXX	3	120	21	22.5	54.0
MVNZ15CXSWPH003C150SAXXXX	3	150	22.4	23.9	57.0
MVNZ15CXSWPH003C185SAXXXX	3	185	24.1	25.6	61.0
MVNZ15CXSWPH003C240SAXXXX	3	240	26.6	28.1	66.0
MVNZ15CXSWPH003C300SAXXXX	3	300	29	30.5	72.0
MVNZ15CXSWPH003C400SAXXXX	3	400	32.2	33.7	79.0
MVNZ15CXSWPH003C500SAXXXX	3	500	36	37.5	88.0

- Above mentioned parameters are based on 3kA/sec earth fault current capacity of copper screen



SPOLYCAB THREE CORE MV AS/NZS 1429.1 3.8/6.6 (7.2) KV
MV Cable with Copper Conductor, XLPE Insulation, Copper Screen and Unarmoured

ELECTRICAL CHARACTERISTICS:

No. of Cores	Core Cross sectional Area	Max. DC Resistance at 20°C	Max. AC Resistance at 90°C	Approx. Capacitance	Approx. Inductance	Approx. Reactance	Continuous Current Rating		
							Buried direct in ground	In a buried duct	In Air
									
No.	mm ²	Ω/km	Ω/km	μF/km	mH/km	Ω/km	Amps		
3	16	1.15	1.466	0.22	0.613	0.193	101	87	109
3	25	0.727	0.927	0.25	0.583	0.183	129	112	142
3	35	0.524	0.668	0.28	0.563	0.177	153	133	170
3	50	0.387	0.494	0.31	0.546	0.171	181	158	204
3	70	0.268	0.342	0.36	0.515	0.162	221	193	253
3	95	0.193	0.247	0.4	0.501	0.157	262	231	304
3	120	0.153	0.196	0.45	0.485	0.152	298	264	351
3	150	0.124	0.159	0.49	0.477	0.150	334	297	398
3	185	0.0991	0.127	0.54	0.467	0.147	377	336	455
3	240	0.0754	0.097	0.58	0.458	0.144	434	390	531
3	300	0.0601	0.078	0.59	0.452	0.142	489	441	606
3	400	0.047	0.062	0.62	0.445	0.140	553	501	696
3	500	0.0366	0.049	0.66	0.438	0.138	632	574	800

*: Current Ratings are based on IEC 60502-2 & IEC 60287, Max. Conductor Temperature at 90°C, Ambient temperature at 30°C in Air / at 20°C in Ground, Thermal resistivity of Soil 1.5 k.m/W & for earthenware ducts 1.2k.m/W and Depth of Laying 0.8m.

Current rating de-rating factors for other than 30°C ambient air temperature.

20	25	35	40	45	50	55	60
1.08	1.04	0.96	0.91	0.87	0.82	0.76	0.71

Current rating de-rating factors for other than 20°C ground temperature.

10	15	25	30	35	40	45	50
1.07	1.04	0.96	0.93	0.89	0.85	0.80	0.76



OUR CERTIFICATION
ISO 9001 | ISO 14001 | ISO 45001



SPOLYCAB THREE CORE MV AS/NZS 1429.1 3.8/6.6 (7.2) KV
MV Cable with Copper Conductor, XLPE Insulation, Copper Screen and Unarmoured

No. of Cores	Core Cross sectional Area	Max. pulling tension on conductor	Charging Current per phase	Zero sequence impedance	Electric Stress at Conductor Screen	Short circuit rating of Phase conductor
No.	mm ²	kN	Amps/Km	Ohms/Km	kV/mm	kA, 1 sec
3	16	1.12	0.26	2.63	2.1	2.3
3	25	1.75	0.3	2.09	2.0	3.6
3	35	2.45	0.33	1.83	2.0	5.0
3	50	3.5	0.37	1.65	1.9	7.2
3	70	4.9	0.43	1.50	1.9	10.0
3	95	6.65	0.48	1.41	1.8	13.6
3	120	8.4	0.54	1.36	1.8	17.1
3	150	10.5	0.58	1.32	1.8	21.4
3	185	12.95	0.64	1.29	1.7	26.4
3	240	16.8	0.69	1.26	1.7	34.3
3	300	21	0.7	1.24	1.5	42.8
3	400	28	0.74	1.22	1.4	56.9
3	500	35	0.79	1.21	1.3	71.5



OUR CERTIFICATION
ISO 9001 | ISO 14001 | ISO 45001



POLYCAB THREE CORE MV AS/NZS 1429.1 3.8/6.6 (7.2) KV
MV Cable with Aluminium Conductor, XLPE Insulation, Copper Screen and Unarmoured

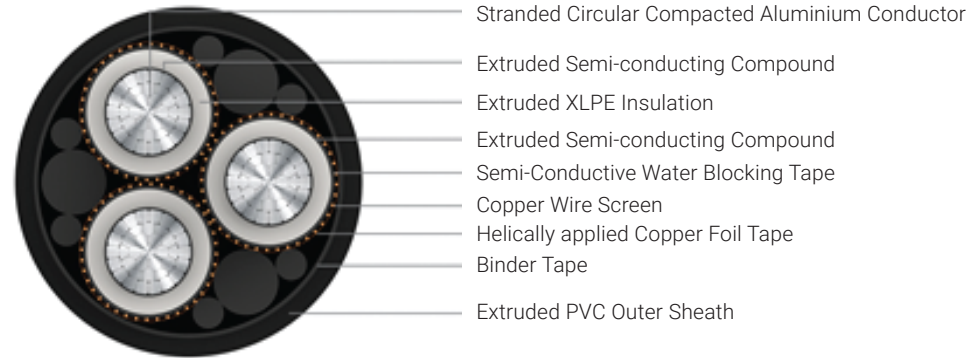

- Salient Features**
- Long life
 - UV resistant
 - Resistant to chemical exposure
 - Resistant to water (AD7/AD8 with HDPE)
 - Resistant to weather exposure

Application
POLYCAB MV 3.8/6.6 KV XLPE insulated with Aluminium conductor Three core cable is suitable to use for power supply to wide networks i.e. Commercial, Industrial and Urban / Residential.

Voltage Rating
Nominal Voltage: 3.8/6.6 (7.2)kV

Operation Temperature
Min. installation temperature: 0°C
Operating temperature: -25°C to +90°C
Emergency operating temperature: 105°C
(max. operation of 36hrs, at 3 periods for 12 consecutive months use)
Max. Short Circuit Temperature: 250°C

- Construction**
- Conductor: Stranded Compacted Circular aluminium conductor as per AS/NZS 1125
 - Conductor Screen: Extruded Semi-conductive compound
 - Insulation: XLPE
 - Insulation Screen: Extruded Strippable Semi-conductive compound
 - Longitudinal Water blocking : Water blocking tape above and below copper screen (Optional)
 - Metallic Insulation Screen: Copper Wire Screen + helicly applied copper tape
 - binder tape / sheath over assembled cores
 - Metallic Sheath: Lead Alloy (optional)
 - Outer Sheath: Extruded Polyvinyl Chloride, Colour: Black
 - Insect attack Protection: Polyamide Nylon (optional)
(Alternative Sheath: PVC + HDPE Outer Sheath or LSZH Outer sheath and parameters will change accordingly)

Bending Radius:
Fixed Installation: 12D (PVC) / 15D (HDPE)
During Installation: 18D (PVC) / 25D (HDPE)
D is overall diameter of cable

Standard and References:
AS/NZS 1429.1
AS/NZS 1125
AS/NZS 3808

High Voltage Test (kV AC)	Partial discharge test (kV AC)		Impulse test Voltage (kV peak)
	200% to rated voltage	150% to rated voltage	
12.5	7.6	5.7	60

- Compliance**
- Conductor resistance AS/NZS 1125
 - Insulation resistance AS/NZS 1429.1
 - Voltage test AS/NZS 1429.1



POLYCAB THREE CORE MV AS/NZS 1429.1 3.8/6.6 (7.2) KV
MV Cable with Aluminium Conductor, XLPE Insulation, Copper Screen and Unarmoured

DIMENSIONAL CHARACTERISTICS:



Product Code	No. of Cores	Core Cross sectional Area	Nominal Diameter		
			Under metallic screen	Over metallic screen	Overall
	No.	mm ²	mm	mm	mm
MVNZ15AXSWPH003C016SAXXXX	3	16	12.8	14.3	35.0
MVNZ15AXSWPH003C025SAXXXX	3	25	14.1	15.6	38.0
MVNZ15AXSWPH003C035SAXXXX	3	35	15.1	16.6	40.0
MVNZ15AXSWPH003C050SAXXXX	3	50	16.2	17.7	43.0
MVNZ15AXSWPH003C070SAXXXX	3	70	17.8	19.3	46.0
MVNZ15AXSWPH003C095SAXXXX	3	95	19.4	20.9	50.0
MVNZ15AXSWPH003C120SAXXXX	3	120	21	22.5	54.0
MVNZ15AXSWPH003C150SAXXXX	3	150	22.3	23.8	57.0
MVNZ15AXSWPH003C185SAXXXX	3	185	24	25.5	61.0
MVNZ15AXSWPH003C240SAXXXX	3	240	26.5	28.0	66.0
MVNZ15AXSWPH003C300SAXXXX	3	300	29.1	30.6	72.0
MVNZ15AXSWPH003C400SAXXXX	3	400	32.2	33.7	79.0
MVNZ15AXSWPH003C500SAXXXX	3	500	36	37.5	88.0

- Above mentioned parameters are based on 3kA/sec earth fault current capacity of copper screen



POLYCAB THREE CORE MV AS/NZS 1429.1 3.8/6.6 (7.2) KV
MV Cable with Aluminium Conductor, XLPE Insulation, Copper Screen and Unarmoured

ELECTRICAL CHARACTERISTICS:

No. of Cores	Core Cross sectional Area	Max. DC Resistance at 20°C	Max. AC Resistance at 90°C	Approx. Capacitance	Approx. Inductance	Approx. Reactance	Continuous Current Rating		
							Buried direct in ground	In a buried duct	In Air
									
No.	mm ²	Ω/km	Ω/km	μF/km	mH/km	Ω/km	Amps		
3	16	1.91	2.449	0.22	0.616	0.194	78	67	84
3	25	1.2	1.539	0.25	0.583	0.183	100	87	110
3	35	0.868	1.113	0.28	0.563	0.177	119	103	132
3	50	0.641	0.822	0.31	0.546	0.171	140	122	158
3	70	0.443	0.568	0.36	0.517	0.162	171	150	196
3	95	0.32	0.411	0.4	0.501	0.157	203	179	236
3	120	0.253	0.325	0.45	0.485	0.152	232	205	273
3	150	0.206	0.265	0.49	0.477	0.150	260	231	309
3	185	0.164	0.211	0.53	0.468	0.147	294	262	355
3	240	0.125	0.161	0.58	0.458	0.144	340	305	415
3	300	0.1	0.129	0.6	0.451	0.142	384	346	475
3	400	0.0778	0.101	0.62	0.445	0.140	438	398	552
3	500	0.0605	0.079	0.66	0.438	0.138	505	460	646

: Current ratings are in accordance with IEC 60502-2: Current Ratings are based on IEC 60502-2 & IEC 60287, Max. Conductor Temperature at 90°C, Ambient temperature at 30°C in Air / at 20°C in Ground, Thermal resistivity of Soil 1.5 k.m/W & for earthenware ducts 1.2k.m/W and Depth of Laying 0.8m.

Current rating de-rating factors for other than 30°C ambient air temperature.

20	25	35	40	45	50	55	60
1.08	1.04	0.96	0.91	0.87	0.82	0.76	0.71

Current rating de-rating factors for other than 20°C ground temperature.

10	15	25	30	35	40	45	50
1.07	1.04	0.96	0.93	0.89	0.85	0.80	0.76

POLYCAB THREE CORE MV AS/NZS 1429.1 3.8/6.6 (7.2) KV
MV Cable with Aluminium Conductor, XLPE Insulation, Copper Screen and Unarmoured

No. of Cores	Core Cross sectional Area	Max. pulling tension on conductor	Charging Current per phase	Zero sequence impedance	Electric Stress at Conductor Screen	Short circuit rating of Phase conductor
No.	mm ²	kN	Amps/Km	Ohms/Km	kV/mm	kA, 1 sec
3	16	0.8	0.26	3.61	2.1	1.4
3	25	1.25	0.3	2.70	2.0	2.3
3	35	1.75	0.33	2.27	2.0	3.1
3	50	2.5	0.37	1.98	1.9	4.5
3	70	3.5	0.43	1.73	1.9	6.2
3	95	4.75	0.48	1.57	1.8	8.5
3	120	6	0.54	1.48	1.8	10.7
3	150	7.5	0.58	1.42	1.8	13.4
3	185	9.25	0.63	1.37	1.7	16.5
3	240	12	0.69	1.32	1.7	21.4
3	300	15	0.72	1.29	1.5	26.8
3	400	20	0.74	1.26	1.4	35.5
3	500	25	0.79	1.24	1.3	44.7



OUR CERTIFICATION
 ISO 9001 | ISO 14001 | ISO 45001



OUR CERTIFICATION
 ISO 9001 | ISO 14001 | ISO 45001



POLYCAB THREE CORE ANTI-TERMITE MV AS/NZS 1429.1 3.8/6.6 (7.2) KV
MV Cable with Aluminium Conductor, XLPE Insulation, Copper Screen and Unarmoured



- Stranded Circular Compacted Aluminium Conductor
- Extruded Semi-conducting Compound
- Extruded XLPE Insulation
- Extruded Semi-conducting Compound
- Semi-Conductive Water Blocking Tape (optional)
- Copper Wire Screen
- Helically applied Copper Foil Tape
- Binder Tape
- Extruded PVC Inner layer
- Polyamide (Nylon-12) Anti-Termite layer
- Extruded HDPE Outer Sheath

Salient Features

- Long life
- UV resistant
- Resistant to chemical exposure
- Resistant to weather exposure
- Resistant to water (AD7/AD8)
- Termite resistant

Application

POLYCAB MV 3.8/6.6 KV XLPE insulated with Aluminium conductor Three core cable is suitable to use for power supply to wide networks i.e. Commercial, Industrial and Urban / Residential.

Voltage Rating

Nominal Voltage: 3.8/6.6 (7.2) kV

Operation Temperature

Min. installation temperature: 0°C
 Operating temperature: -25°C to +90°C
 Emergency operating temperature: 105°C
 (max. operation of 36hrs, at 3 periods for 12 consecutive months use)
 Max. Short Circuit Temperature: 250°C

Construction

- Conductor: Stranded Compacted Circular aluminium conductor as per AS/NZS 1125
- Conductor Screen: Extruded Semi-conductive compound
- Insulation: XLPE
- Insulation Screen: Extruded Semi-conductive compound
- Longitudinal Water blocking : Water blocking tape above and below copper screen (Optional)
- Metallic Insulation Screen: Copper Wire Screen + helically applied copper tape
- binder tape / sheath over assembled cores
- Composite sheath**
- Inner layer : Extruded Polyvinyl Chloride, Colour: Orange
- Termite Protection: Polyamide (Nylon -12)
- Outer layer: HDPE (Black)

Bending Radius:

Fixed Installation: 20D
 During Installation: 30D

D is diameter over nylon

Standard and References:

AS/NZS 1429.1
 AS/NZS 1125
 AS/NZS 3808

High Voltage Test (kV AC)	Partial discharge test (kV AC)		Impulse test Voltage (kV peak)
	200% to rated voltage	150% to rated voltage	
12.5	7.6	5.7	60

Compliance

- Conductor resistance AS/NZS 1125
- Insulation resistance AS/NZS 1429.1
- Voltage test AS/NZS 1429.1



POLYCAB THREE CORE ANTI-TERMITE MV AS/NZS 1429.1 3.8/6.6 (7.2) KV
MV Cable with Aluminium Conductor, XLPE Insulation, Copper Screen and Unarmoured

DIMENSIONAL CHARACTERISTICS:



Product Code	No. of Cores	Core Cross sectional Area	Nominal Diameter		
			Under metallic screen	Over metallic screen	Overall
	No.	mm ²	mm	mm	mm
MVNZ15AXUAPH003C016SAXXXX	3	16	12.8	14.3	35.0
MVNZ15AXUAPH003C025SAXXXX	3	25	14.1	15.6	38.0
MVNZ15AXUAPH003C035SAXXXX	3	35	15.1	16.6	40.0
MVNZ15AXUAPH003C050SAXXXX	3	50	16.2	17.7	43.0
MVNZ15AXUAPH003C070SAXXXX	3	70	17.8	19.3	47.0
MVNZ15AXUAPH003C095SAXXXX	3	95	19.4	20.9	50.0
MVNZ15AXUAPH003C120SAXXXX	3	120	21	22.5	54.0
MVNZ15AXUAPH003C150SAXXXX	3	150	22.3	23.8	57.0
MVNZ15AXUAPH003C185SAXXXX	3	185	24	25.5	61.0
MVNZ15AXUAPH003C240SAXXXX	3	240	26.5	28.0	67.0
MVNZ15AXUAPH003C300SAXXXX	3	300	29.1	30.6	72.0
MVNZ15AXUAPH003C400SAXXXX	3	400	32.2	33.7	80.0
MVNZ15AXUAPH003C500SAXXXX	3	500	36	37.5	89.0

- Above mentioned parameters are based on 3kA/sec earth fault current capacity of copper screen



POLYCAB THREE CORE ANTI-TERMITE MV AS/NZS 1429.1 3.8/6.6 (7.2) KV
MV Cable with Aluminium Conductor, XLPE Insulation, Copper Screen and Unarmoured

ELECTRICAL CHARACTERISTICS:

No. of Cores	Core Cross sectional Area	Max. DC Resistance at 20°C	Max. AC Resistance at 90°C	Approx. Capacitance	Approx. Inductance	Approx. Reactance	Continuous Current Rating		
							Buried direct in ground	In a buried duct	In Air
									
No.	mm ²	Ω/km	Ω/km	μF/km	mH/km	Ω/km	Amps		
3	16	1.91	2.449	0.22	0.618	0.194	78	67	84
3	25	1.2	1.539	0.25	0.586	0.184	100	87	110
3	35	0.868	1.113	0.28	0.565	0.177	119	103	132
3	50	0.641	0.822	0.31	0.548	0.172	140	122	158
3	70	0.443	0.568	0.36	0.518	0.163	171	150	196
3	95	0.32	0.411	0.4	0.503	0.158	203	179	236
3	120	0.253	0.325	0.45	0.487	0.153	232	205	273
3	150	0.206	0.265	0.49	0.479	0.150	260	231	309
3	185	0.164	0.211	0.53	0.470	0.148	294	262	355
3	240	0.125	0.161	0.58	0.459	0.144	340	305	415
3	300	0.1	0.129	0.6	0.452	0.142	384	346	475
3	400	0.0778	0.101	0.62	0.447	0.140	438	398	552
3	500	0.0605	0.079	0.66	0.439	0.138	505	460	646

: Current ratings are in accordance with IEC 60502-2: Current Ratings are based on IEC 60502-2 & IEC 60287, Max. Conductor Temperature at 90°C, Ambient temperature at 30°C in Air / at 20°C in Ground, Thermal resistivity of Soil 1.5 k.m/W & for earthenware ducts 1.2k.m/W and Depth of Laying 0.8m.

Current rating de-rating factors for other than 30°C ambient air temperature.

20	25	35	40	45	50	55	60
1.08	1.04	0.96	0.91	0.87	0.82	0.76	0.71

Current rating de-rating factors for other than 20°C ground temperature.

10	15	25	30	35	40	45	50
1.07	1.04	0.96	0.93	0.89	0.85	0.80	0.76

POLYCAB THREE CORE ANTI-TERMITE MV AS/NZS 1429.1 3.8/6.6 (7.2) KV
MV Cable with Aluminium Conductor, XLPE Insulation, Copper Screen and Unarmoured

No. of Cores	Core Cross sectional Area	Max. pulling tension on conductor	Charging Current per phase	Zero sequence impedance	Electric Stress at Conductor Screen	Short circuit rating of Phase conductor
No.	mm ²	kN	Amps/Km	Ohms/Km	kV/mm	kA, 1 sec
3	16	0.8	0.26	3.61	2.1	1.4
3	25	1.25	0.3	2.70	2.0	2.3
3	35	1.75	0.33	2.27	2.0	3.1
3	50	2.5	0.37	1.98	1.9	4.5
3	70	3.5	0.43	1.73	1.9	6.2
3	95	4.75	0.48	1.57	1.8	8.5
3	120	6	0.54	1.48	1.8	10.7
3	150	7.5	0.58	1.42	1.8	13.4
3	185	9.25	0.63	1.37	1.7	16.5
3	240	12	0.69	1.32	1.7	21.4
3	300	15	0.72	1.29	1.5	26.8
3	400	20	0.74	1.26	1.4	35.5
3	500	25	0.79	1.24	1.3	44.7



OUR CERTIFICATION
 ISO 9001 | ISO 14001 | ISO 45001



OUR CERTIFICATION
 ISO 9001 | ISO 14001 | ISO 45001



POLYCAB THREE CORE MV AS/NZS 1429.1 6.35/11 (12) KV
MV Cable with Copper Conductor, XLPE Insulation, Copper Screen and Unarmoured

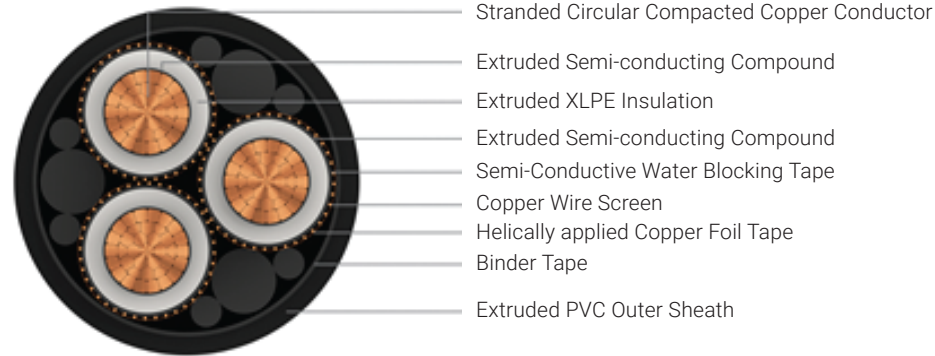

- Salient Features**
- Long life
 - UV resistant
 - Resistant to chemical exposure
 - Resistant to water (AD7/AD8 with HDPE)
 - Resistant to weather exposure
 - Termite resistant (Optional)

Application
POLYCAB MV 6.35/11 KV XLPE insulated with Copper conductor Three core cable is suitable to use for power supply to wide networks i.e. Commercial, Industrial and Urban / Residential.

Voltage Rating
Nominal Voltage: : 6.35/11 (12) kV

Operation Temperature
Min. installation temperature: 0°C
Operating temperature: -25°C to +90°C
Emergency operating temperature: 105°C
(max. operation of 36hrs, at 3 periods for 12 consecutive months use)
Max. Short Circuit Temperature: 250°C

- Construction**
- Conductor: Stranded Compacted Circular Copper conductor as per AS/NZS 1125
 - Conductor Screen: Extruded Semi-conductive compound
 - Insulation: XLPE
 - Insulation Screen: Extruded Semi-conductive compound
 - Longitudinal Water blocking : Water blocking tape below copper screen (Optional)
 - Metallic Insulation Screen: Copper Wire Screen + helically applied copper tape (E/F current capacity – Based on requirement)
 - binder tape / sheath over assembled cores
 - Metallic Sheath: Lead Alloy (optional)
 - Outer Sheath: Extruded Polyvinyl Chloride, Colour: Black
 - Insect attack Protection: Polyamide Nylon (optional)
(Alternative Sheath: PVC+HDPE Composite Sheath or PVC + Nylon + HDPE (composite sheath with anti-termite properties) or LSZH Outer sheath, and parameters will change accordingly)

Bending Radius:
Fixed Installation: 12D (PVC) / 15D (HDPE) / 20D (Nylon)
During Installation: 18D (PVC) / 25D (HDPE) / 30D (Nylon)

D is overall diameter of cable

Standard and References:
AS/NZS 1429.1
AS/NZS 1125
AS/NZS 3808

High Voltage Test (kV AC)	Partial discharge test (kV AC)		Impulse test Voltage (kV peak)
	200% to rated voltage	150% to rated voltage	
21	13	10	95

- Compliance**
- Conductor resistance AS/NZS 1125
 - Insulation resistance AS/NZS 1429.1
 - Voltage test AS/NZS 1429.1



POLYCAB THREE CORE MV AS/NZS 1429.1 6.35/11 (12) KV
MV Cable with Copper Conductor, XLPE Insulation, Copper Screen and Unarmoured

DIMENSIONAL CHARACTERISTICS:



Product Code	No. of Cores	Core Cross sectional Area	Nominal Diameter		
			Under metallic screen	Over metallic screen	Overall
	No.	mm ²	mm	mm	mm
MVNZ17CXUAPH003C016SAXXXX	3	16	14.7	16.2	39.0
MVNZ17CXUAPH003C025SAXXXX	3	25	15.9	17.4	42.0
MVNZ17CXUAPH003C035SAXXXX	3	35	16.9	18.4	44.0
MVNZ17CXUAPH003C050SAXXXX	3	50	18	19.5	47.0
MVNZ17CXUAPH003C070SAXXXX	3	70	19.7	21.2	51.0
MVNZ17CXUAPH003C095SAXXXX	3	95	21.2	22.7	54.0
MVNZ17CXUAPH003C120SAXXXX	3	120	22.8	24.3	58.0
MVNZ17CXUAPH003C150SAXXXX	3	150	24.2	25.7	61.0
MVNZ17CXUAPH003C185SAXXXX	3	185	25.9	27.4	65.0
MVNZ17CXUAPH003C240SAXXXX	3	240	28.2	29.7	70.0
MVNZ17CXUAPH003C300SAXXXX	3	300	30.2	31.7	75.0
MVNZ17CXUAPH003C400SAXXXX	3	400	33	34.5	81.0
MVNZ17CXUAPH003C500SAXXXX	3	500	36.4	37.9	89.0

- Above mentioned parameters are based on 3kA/sec earth fault current capacity of copper screen



POLYCAB THREE CORE MV AS/NZS 1429.1 6.35/11 (12) KV
MV Cable with Copper Conductor, XLPE Insulation, Copper Screen and Unarmoured

ELECTRICAL CHARACTERISTICS:

No. of Cores	Core Cross sectional Area	Max. DC Resistance at 20°C	Max. AC Resistance at 90°C	Approx. Capacitance	Approx. Inductance	Approx. Reactance	Continuous Current Rating		
							Buried direct in ground	In a buried duct	In Air
									
No.	mm ²	Ω/km	Ω/km	μF/km	mH/km	Ω/km	Amps		
3	16	1.15	1.466	0.18	0.637	0.200	101	87	109
3	25	0.727	0.927	0.2	0.605	0.190	129	112	142
3	35	0.524	0.668	0.22	0.583	0.183	153	133	170
3	50	0.387	0.494	0.25	0.565	0.177	181	158	204
3	70	0.268	0.342	0.28	0.533	0.168	221	193	253
3	95	0.193	0.246	0.31	0.518	0.163	262	231	304
3	120	0.153	0.196	0.35	0.501	0.157	298	264	351
3	150	0.124	0.159	0.38	0.491	0.154	334	297	398
3	185	0.0991	0.127	0.41	0.481	0.151	377	336	455
3	240	0.0754	0.097	0.46	0.469	0.147	434	390	531
3	300	0.0601	0.078	0.5	0.459	0.144	489	441	606
3	400	0.047	0.062	0.56	0.450	0.141	553	501	696
3	500	0.0366	0.049	0.63	0.440	0.138	632	574	800

*: Current Ratings are based on IEC 60502-2 & IEC 60287, Max. Conductor Temperature at 90°C, Ambient temperature at 30°C in Air / at 20°C in Ground, Thermal resistivity of Soil 1.5 k.m/W & for earthenware ducts 1.2k.m/W and Depth of Laying 0.8m.

Current rating de-rating factors for other than 30°C ambient air temperature.

20	25	35	40	45	50	55	60
1.08	1.04	0.96	0.91	0.87	0.82	0.76	0.71

Current rating de-rating factors for other than 20°C ground temperature.

10	15	25	30	35	40	45	50
1.07	1.04	0.96	0.93	0.89	0.85	0.80	0.76

POLYCAB THREE CORE MV AS/NZS 1429.1 6.35/11 (12) KV
MV Cable with Copper Conductor, XLPE Insulation, Copper Screen and Unarmoured

No. of Cores	Core Cross sectional Area	Max. pulling tension on conductor	Charging Current per phase	Zero sequence impedance	Electric Stress at Conductor Screen	Short circuit rating of Phase conductor
No.	mm ²	kN	Amps/Km	Ohms/Km	kV/mm	kA, 1 sec
3	16	1.12	0.36	2.63	2.8	2.3
3	25	1.75	0.4	2.09	2.7	3.6
3	35	2.45	0.44	1.83	2.6	5.0
3	50	3.5	0.5	1.65	2.5	7.2
3	70	4.9	0.56	1.50	2.4	10.0
3	95	6.65	0.62	1.41	2.3	13.6
3	120	8.4	0.7	1.36	2.3	17.1
3	150	10.5	0.76	1.32	2.3	21.4
3	185	12.95	0.82	1.29	2.2	26.4
3	240	16.8	0.92	1.26	2.2	34.3
3	300	21	1	1.24	2.2	42.8
3	400	28	1.12	1.22	2.1	56.9
3	500	35	1.26	1.21	2.1	71.5



OUR CERTIFICATION
 ISO 9001 | ISO 14001 | ISO 45001



OUR CERTIFICATION
 ISO 9001 | ISO 14001 | ISO 45001



POLYCAB THREE CORE MV AS/NZS 1429.1 6.35/11 (12) KV
MV Cable with Aluminium Conductor, XLPE Insulation, Copper Screen and Unarmoured

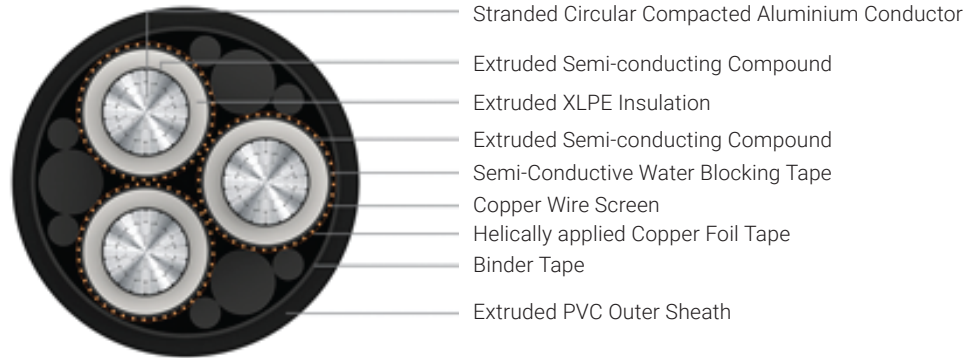

- Salient Features**
- Long life
 - UV resistant
 - Resistant to chemical exposure
 - Resistant to water (AD7/AD8 with HDPE)
 - Resistant to weather exposure

Application
POLYCAB MV 6.35/11 KV XLPE insulated with Aluminium conductor Three core cable is suitable to use for power supply to wide networks i.e. Commercial, Industrial and Urban / Residential.

Voltage Rating
Nominal Voltage: 6.35/11 (12) kV

Operation Temperature
Min. installation temperature: 0°C
Operating temperature: -25°C to +90°C
Emergency operating temperature: 105°C
(max. operation of 36hrs, at 3 periods for 12 consecutive months use)
Max. Short Circuit Temperature: 250°C

- Construction**
- Conductor: Stranded Compacted Circular aluminium conductor as per AS/NZS 1125
 - Conductor Screen: Extruded Semi-conductive compound
 - Insulation: XLPE
 - Insulation Screen: Extruded Strippable Semi-conductive compound
 - Longitudinal Water blocking : Water blocking tape above and below copper screen (Optional)
 - Metallic Insulation Screen: Copper Wire Screen + helically applied copper tape
 - binder tape / sheath over assembled cores
 - Metallic Sheath: Lead Alloy (optional)
 - Outer Sheath: Extruded Polyvinyl Chloride, Colour: Black
 - Insect attack Protection: Polyamide Nylon (optional)
(Alternative Sheath: PVC + HDPE Outer Sheath or LSZH Outer sheath and parameters will change accordingly)

Bending Radius:
Fixed Installation: 12D (PVC) / 15D (HDPE)
During Installation: 18D (PVC) / 25D (HDPE)

D is overall diameter of cable

Standard and References:
AS/NZS 1429.1
AS/NZS 1125
AS/NZS 3808

High Voltage Test (kV AC)	Partial discharge test (kV AC)		Impulse test Voltage (kV peak)
	200% to rated voltage	150% to rated voltage	
21	13	10	95

- Compliance**
- Conductor resistance AS/NZS 1125
 - Insulation resistance AS/NZS 1429.1
 - Voltage test AS/NZS 1429.1



POLYCAB THREE CORE MV AS/NZS 1429.1 6.35/11 (12) KV
MV Cable with Aluminium Conductor, XLPE Insulation, Copper Screen and Unarmoured

DIMENSIONAL CHARACTERISTICS:



Product Code	No. of Cores	Core Cross sectional Area	Nominal Diameter		
			Under metallic screen	Over metallic screen	Overall
	No.	mm ²	mm	mm	mm
MVNZ17AXUAPH003C016SAXXXX	3	16	14.6	16.1	39.0
MVNZ17AXUAPH003C025SAXXXX	3	25	15.9	17.4	42.0
MVNZ17AXUAPH003C035SAXXXX	3	35	16.9	18.4	44.0
MVNZ17AXUAPH003C050SAXXXX	3	50	18	19.5	47.0
MVNZ17AXUAPH003C070SAXXXX	3	70	19.6	21.1	51.0
MVNZ17AXUAPH003C095SAXXXX	3	95	21.2	22.7	54.0
MVNZ17AXUAPH003C120SAXXXX	3	120	22.8	24.3	58.0
MVNZ17AXUAPH003C150SAXXXX	3	150	24.1	25.6	61.0
MVNZ17AXUAPH003C185SAXXXX	3	185	25.8	27.3	65.0
MVNZ17AXUAPH003C240SAXXXX	3	240	28.1	29.6	70.0
MVNZ17AXUAPH003C300SAXXXX	3	300	30.3	31.8	75.0
MVNZ17AXUAPH003C400SAXXXX	3	400	33	34.5	81.0
MVNZ17AXUAPH003C500SAXXXX	3	500	36.4	37.9	89.0

- Above mentioned parameters are based on 3kA/sec earth fault current capacity of copper screen



POLYCAB THREE CORE MV AS/NZS 1429.1 6.35/11 (12) KV
MV Cable with Aluminium Conductor, XLPE Insulation, Copper Screen and Unarmoured

ELECTRICAL CHARACTERISTICS:

No. of Cores	Core Cross sectional Area	Max. DC Resistance at 20°C	Max. AC Resistance at 90°C	Approx. Capacitance	Approx. Inductance	Approx. Reactance	Continuous Current Rating		
							Buried direct in ground	In a buried duct	In Air
									
No.	mm ²	Ω/km	Ω/km	μF/km	mH/km	Ω/km	Amps		
3	16	1.91	2.449	0.17	0.640	0.201	78	67	84
3	25	1.2	1.539	0.2	0.605	0.190	100	87	110
3	35	0.868	1.113	0.22	0.583	0.183	119	103	132
3	50	0.641	0.822	0.25	0.565	0.177	140	122	158
3	70	0.443	0.568	0.28	0.535	0.168	171	150	196
3	95	0.32	0.411	0.31	0.518	0.163	203	179	236
3	120	0.253	0.325	0.35	0.501	0.157	232	205	273
3	150	0.206	0.264	0.37	0.492	0.154	260	231	309
3	185	0.164	0.211	0.41	0.481	0.151	294	262	355
3	240	0.125	0.161	0.46	0.470	0.148	340	305	415
3	300	0.1	0.129	0.5	0.459	0.144	384	346	475
3	400	0.0778	0.101	0.56	0.450	0.141	438	398	552
3	500	0.0605	0.079	0.63	0.440	0.138	505	460	646

: Current ratings are in accordance with IEC 60502-2: Current Ratings are based on IEC 60502-2 & IEC 60287, Max. Conductor Temperature at 90°C, Ambient temperature at 30°C in Air / at 20°C in Ground, Thermal resistivity of Soil 1.5 k.m/W & for earthenware ducts 1.2k.m/W and Depth of Laying 0.8m.

Current rating de-rating factors for other than 30°C ambient air temperature.

20	25	35	40	45	50	55	60
1.08	1.04	0.96	0.91	0.87	0.82	0.76	0.71

Current rating de-rating factors for other than 20°C ground temperature.

10	15	25	30	35	40	45	50
1.07	1.04	0.96	0.93	0.89	0.85	0.80	0.76

POLYCAB THREE CORE MV AS/NZS 1429.1 6.35/11 (12) KV
MV Cable with Aluminium Conductor, XLPE Insulation, Copper Screen and Unarmoured

No. of Cores	Core Cross sectional Area	Max. pulling tension on conductor	Charging Current per phase	Zero sequence impedance	Electric Stress at Conductor Screen	Short circuit rating of Phase conductor
No.	mm ²	kN	Amps/Km	Ohms/Km	kV/mm	kA, 1 sec
3	16	0.8	0.34	3.61	2.9	1.4
3	25	1.25	0.4	2.70	2.7	2.3
3	35	1.75	0.44	2.27	2.6	3.1
3	50	2.5	0.5	1.98	2.5	4.5
3	70	3.5	0.56	1.73	2.4	6.2
3	95	4.75	0.62	1.57	2.3	8.5
3	120	6	0.7	1.48	2.3	10.7
3	150	7.5	0.74	1.42	2.3	13.4
3	185	9.25	0.82	1.37	2.2	16.5
3	240	12	0.92	1.32	2.2	21.4
3	300	15	1	1.29	2.2	26.8
3	400	20	1.12	1.26	2.1	35.5
3	500	25	1.26	1.24	2.1	44.7



OUR CERTIFICATION
 ISO 9001 | ISO 14001 | ISO 45001



OUR CERTIFICATION
 ISO 9001 | ISO 14001 | ISO 45001



POLYCAB THREE CORE ANTI-TERMITE MV AS/NZS 1429.1 6.35/11 (12) KV
MV Cable with Aluminium Conductor, XLPE Insulation, Copper Screen and Unarmoured



- Stranded Circular Compacted Aluminium Conductor
- Extruded Semi-conducting Compound
- Extruded XLPE Insulation
- Extruded Semi-conducting Compound
- Semi-Conductive Water Blocking Tape (optional)
- Copper Wire Screen
- Helically applied Copper Foil Tape
- Binder Tape
- Extruded PVC Inner layer
- Polyamide (Nylon-12) Anti-Termite layer
- Extruded HDPE Outer Sheath

Salient Features

- Long life
- UV resistant
- Resistant to chemical exposure
- Resistant to weather exposure
- Resistant to water (AD7/AD8)
- Termite resistant

Application

POLYCAB MV 6.35/11 KV XLPE insulated with Aluminium conductor Three core cable is suitable to use for power supply to wide networks i.e. Commercial, Industrial and Urban / Residential.

Voltage Rating

Nominal Voltage: 6.35/11 (12) kV

Operation Temperature

Min. installation temperature: 0°C
 Operating temperature: -25°C to +90°C
 Emergency operating temperature: 105°C
 (max. operation of 36hrs, at 3 periods for 12 consecutive months use)
 Max. Short Circuit Temperature: 250°C

Construction

- Conductor: Stranded Compacted Circular aluminium conductor as per AS/NZS 1125
- Conductor Screen: Extruded Semi-conductive compound
- Insulation: XLPE
- Insulation Screen: Extruded Semi-conductive compound
- Longitudinal Water blocking : Water blocking tape above and below copper screen (Optional)
- Metallic Insulation Screen: Copper Wire Screen + helically applied copper tape
- binder tape / sheath over assembled cores

Composite sheath

- Inner layer : Extruded Polyvinyl Chloride, Colour: Orange
- Termite Protection: Polyamide (Nylon -12)
- Outer layer: HDPE (Black)

Bending Radius:

Fixed Installation: 20D
 During Installation: 30D

D is diameter over nylon

Standard and References:

AS/NZS 1429.1
 AS/NZS 1125
 AS/NZS 3808

High Voltage Test (kV AC)	Partial discharge test (kV AC)		Impulse test Voltage (kV peak)
	200% to rated voltage	150% to rated voltage	
21	13	10	95

Compliance

- Conductor resistance AS/NZS 1125
- Insulation resistance AS/NZS 1429.1
- Voltage test AS/NZS 1429.1



POLYCAB THREE CORE ANTI-TERMITE MV AS/NZS 1429.1 6.35/11 (12) KV
MV Cable with Aluminium Conductor, XLPE Insulation, Copper Screen and Unarmoured

DIMENSIONAL CHARACTERISTICS:



Product Code	No. of Cores	Core Cross sectional Area	Nominal Diameter		
			Under metallic screen	Over metallic screen	Overall
	No.	mm ²	mm	mm	mm
MVNZ15AXUAPH003C016SAXXXX	3	16	14.6	16.1	39.0
MVNZ15AXUAPH003C025SAXXXX	3	25	15.9	17.4	43.0
MVNZ15AXUAPH003C035SAXXXX	3	35	16.9	18.4	45.0
MVNZ15AXUAPH003C050SAXXXX	3	50	18	19.5	47.0
MVNZ15AXUAPH003C070SAXXXX	3	70	19.6	21.1	51.0
MVNZ15AXUAPH003C095SAXXXX	3	95	21.2	22.7	55.0
MVNZ15AXUAPH003C120SAXXXX	3	120	22.8	24.3	58.0
MVNZ15AXUAPH003C150SAXXXX	3	150	24.1	25.6	61.0
MVNZ15AXUAPH003C185SAXXXX	3	185	25.8	27.3	65.0
MVNZ15AXUAPH003C240SAXXXX	3	240	28.1	29.6	70.0
MVNZ15AXUAPH003C300SAXXXX	3	300	30.3	31.8	75.0
MVNZ15AXUAPH003C400SAXXXX	3	400	33	34.5	82.0
MVNZ15AXUAPH003C500SAXXXX	3	500	36.4	37.9	89.0

- Above mentioned parameters are based on 3kA/sec earth fault current capacity of copper screen



POLYCAB THREE CORE ANTI-TERMITE MV AS/NZS 1429.1 6.35/11 (12) KV
MV Cable with Aluminium Conductor, XLPE Insulation, Copper Screen and Unarmoured

ELECTRICAL CHARACTERISTICS:

No. of Cores	Core Cross sectional Area	Max. DC Resistance at 20°C	Max. AC Resistance at 90°C	Approx. Capacitance	Approx. Inductance	Approx. Reactance	Continuous Current Rating		
							Buried direct in ground	In a buried duct	In Air
									
No.	mm ²	Ω/km	Ω/km	μF/km	mH/km	Ω/km	Amps		
3	16	1.91	2.449	0.17	0.642	0.202	78	67	84
3	25	1.2	1.539	0.2	0.607	0.191	100	87	110
3	35	0.868	1.113	0.22	0.586	0.184	119	103	132
3	50	0.641	0.822	0.25	0.566	0.178	140	122	158
3	70	0.443	0.568	0.28	0.536	0.168	171	150	196
3	95	0.32	0.411	0.31	0.520	0.163	203	179	236
3	120	0.253	0.325	0.35	0.502	0.158	232	205	273
3	150	0.206	0.264	0.37	0.493	0.155	260	231	309
3	185	0.164	0.211	0.41	0.482	0.151	294	262	355
3	240	0.125	0.161	0.46	0.471	0.148	340	305	415
3	300	0.1	0.129	0.5	0.460	0.145	384	346	475
3	400	0.0778	0.101	0.56	0.451	0.142	438	398	552
3	500	0.0605	0.079	0.63	0.441	0.139	505	460	646

: Current ratings are in accordance with IEC 60502-2: Current Ratings are based on IEC 60502-2 & IEC 60287, Max. Conductor Temperature at 90°C, Ambient temperature at 30°C in Air / at 20°C in Ground, Thermal resistivity of Soil 1.5 k.m/W & for earthenware ducts 1.2k.m/W and Depth of Laying 0.8m.

Current rating de-rating factors for other than 30°C ambient air temperature.

20	25	35	40	45	50	55	60
1.08	1.04	0.96	0.91	0.87	0.82	0.76	0.71

Current rating de-rating factors for other than 20°C ground temperature.

10	15	25	30	35	40	45	50
1.07	1.04	0.96	0.93	0.89	0.85	0.80	0.76

POLYCAB THREE CORE ANTI-TERMITE MV AS/NZS 1429.1 6.35/11 (12) KV
MV Cable with Aluminium Conductor, XLPE Insulation, Copper Screen and Unarmoured

No. of Cores	Core Cross sectional Area	Max. pulling tension on conductor	Charging Current per phase	Zero sequence impedance	Electric Stress at Conductor Screen	Short circuit rating of Phase conductor
No.	mm ²	kN	Amps/Km	Ohms/Km	kV/mm	kA, 1 sec
3	16	0.8	0.34	3.61	2.9	1.4
3	25	1.25	0.4	2.70	2.7	2.3
3	35	1.75	0.44	2.27	2.6	3.1
3	50	2.5	0.5	1.98	2.5	4.5
3	70	3.5	0.56	1.73	2.4	6.2
3	95	4.75	0.62	1.57	2.3	8.5
3	120	6	0.7	1.48	2.3	10.7
3	150	7.5	0.74	1.42	2.3	13.4
3	185	9.25	0.82	1.37	2.2	16.5
3	240	12	0.92	1.32	2.2	21.4
3	300	15	1	1.29	2.2	26.8
3	400	20	1.12	1.26	2.1	35.5
3	500	25	1.26	1.24	2.1	44.7



OUR CERTIFICATION
 ISO 9001 | ISO 14001 | ISO 45001



OUR CERTIFICATION
 ISO 9001 | ISO 14001 | ISO 45001



POLYCAB THREE CORE MV AS/NZS 1429.1 12.7/22 (24) KV
MV Cable with Copper Conductor, XLPE Insulation, Copper Screen and Unarmoured

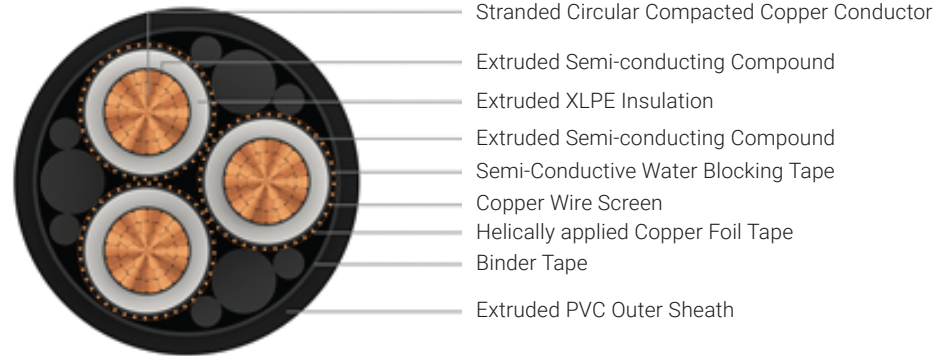

- Salient Features**
- Long life
 - UV resistant
 - Resistant to chemical exposure
 - Resistant to water (AD7/AD8 with HDPE)
 - Resistant to weather exposure
 - Termite resistant (Optional)

Application
POLYCAB MV 12.7/22 KV XLPE insulated with Copper conductor Three core cable is suitable to use for power supply to wide networks i.e. Commercial, Industrial and Urban / Residential.

Voltage Rating
Nominal Voltage: 12.7/22 (24) kV

Operation Temperature
Min. installation temperature: 0°C
Operating temperature: -25°C to +90°C
Emergency operating temperature: 105°C
(max. operation of 36hrs, at 3 periods for 12 consecutive months use)
Max. Short Circuit Temperature: 250°C

- Construction**
- Conductor: Stranded Compacted Circular Copper conductor as per AS/NZS 1125
 - Conductor Screen: Extruded Semi-conductive compound
 - Insulation: XLPE
 - Insulation Screen: Extruded Semi-conductive compound
 - Longitudinal Water blocking : Water blocking tape below copper screen (Optional)
 - Metallic Insulation Screen: Copper Wire Screen + helically applied copper tape (E/F current capacity – Based on requirement)
 - binder tape / sheath over assembled cores
 - Metallic Sheath: Lead Alloy (optional)
 - Outer Sheath: Extruded Polyvinyl Chloride, Colour: Black
 - Insect attack Protection: Polyamide Nylon (optional)
(Alternative Sheath: PVC+HDPE Composite Sheath or PVC + Nylon + HDPE (composite sheath with anti-termite properties) or LSZH Outer sheath, and parameters will change accordingly)

Bending Radius:
Fixed Installation: 12D (PVC) / 15D (HDPE) / 20D (Nylon)
During Installation: 18D (PVC) / 25D (HDPE) / 30D (Nylon)

D is overall diameter of cable

Standard and References:
AS/NZS 1429.1
AS/NZS 1125
AS/NZS 3808

High Voltage Test (kV AC)	Partial discharge test (kV AC)		Impulse test Voltage (kV peak)
	200% to rated voltage	150% to rated voltage	
45	25	19	150

- Compliance**
- Conductor resistance AS/NZS 1125
 - Insulation resistance AS/NZS 1429.1
 - Voltage test AS/NZS 1429.1



POLYCAB THREE CORE MV AS/NZS 1429.1 12.7/22 (24) KV
MV Cable with Copper Conductor, XLPE Insulation, Copper Screen and Unarmoured

DIMENSIONAL CHARACTERISTICS:



Product Code	No. of Cores	Core Cross sectional Area	Nominal Diameter		
			Under metallic screen	Over metallic screen	Overall
	No.	mm ²	mm	mm	mm
MVNZ12CXUAPH003C035SAXXXX	3	35	21.1	22.6	54.0
MVNZ12CXUAPH003C050SAXXXX	3	50	22.2	23.7	57.0
MVNZ12CXUAPH003C070SAXXXX	3	70	23.9	25.4	60.0
MVNZ12CXUAPH003C095SAXXXX	3	95	25.4	26.9	64.0
MVNZ12CXUAPH003C120SAXXXX	3	120	27	28.5	67.0
MVNZ12CXUAPH003C150SAXXXX	3	150	28.4	29.9	71.0
MVNZ12CXUAPH003C185SAXXXX	3	185	30.1	31.6	75.0
MVNZ12CXUAPH003C240SAXXXX	3	240	32.4	33.9	80.0
MVNZ12CXUAPH003C300SAXXXX	3	300	34.4	35.9	84.0
MVNZ12CXUAPH003C400SAXXXX	3	400	37.2	38.7	91.0
MVNZ12CXUAPH003C500SAXXXX	3	500	40.6	42.1	99.0

- Above mentioned parameters are based on 3kA/sec earth fault current capacity of copper screen



POLYCAB THREE CORE MV AS/NZS 1429.1 12.7/22 (24) KV
MV Cable with Copper Conductor, XLPE Insulation, Copper Screen and Unarmoured

ELECTRICAL CHARACTERISTICS:

No. of Cores	Core Cross sectional Area	Max. DC Resistance at 20°C	Max. AC Resistance at 90°C	Approx. Capacitance	Approx. Inductance	Approx. Reactance	Continuous Current Rating		
							Buried direct in ground	In a buried duct	In Air
									
No.	mm ²	Ω/km	Ω/km	μF/km	mH/km	Ω/km	Amps		
3	35	0.524	0.668	0.16	0.625	0.196	153	133	170
3	50	0.387	0.494	0.17	0.604	0.190	181	158	204
3	70	0.268	0.342	0.2	0.569	0.179	221	193	253
3	95	0.193	0.246	0.22	0.551	0.173	262	231	304
3	120	0.153	0.196	0.24	0.533	0.167	298	264	351
3	150	0.124	0.159	0.26	0.521	0.164	334	297	398
3	185	0.0991	0.127	0.28	0.509	0.160	377	336	455
3	240	0.0754	0.097	0.31	0.496	0.156	434	390	531
3	300	0.0601	0.078	0.33	0.484	0.152	489	441	606
3	400	0.047	0.062	0.37	0.473	0.149	553	501	696
3	500	0.0366	0.049	0.41	0.462	0.145	632	574	800

*: Current Ratings are based on IEC 60502-2 & IEC 60287, Max. Conductor Temperature at 90°C, Ambient temperature at 30°C in Air / at 20°C in Ground, Thermal resistivity of Soil 1.5 k.m/W & for earthenware ducts 1.2k.m/W and Depth of Laying 0.8m.

Current rating de-rating factors for other than 30°C ambient air temperature.

20	25	35	40	45	50	55	60
1.08	1.04	0.96	0.91	0.87	0.82	0.76	0.71

Current rating de-rating factors for other than 20°C ground temperature.

10	15	25	30	35	40	45	50
1.07	1.04	0.96	0.93	0.89	0.85	0.80	0.76

POLYCAB THREE CORE MV AS/NZS 1429.1 12.7/22 (24) KV
MV Cable with Copper Conductor, XLPE Insulation, Copper Screen and Unarmoured

No. of Cores	Core Cross sectional Area	Max. pulling tension on conductor	Charging Current per phase	Zero sequence impedance	Electric Stress at Conductor Screen	Short circuit rating of Phase conductor
No.	mm ²	kN	Amps/Km	Ohms/Km	kV/mm	kA, 1 sec
3	35	2.45	0.64	1.83	3.7	5.0
3	50	3.5	0.68	1.66	3.5	7.2
3	70	4.9	0.8	1.50	3.4	10.0
3	95	6.65	0.88	1.41	3.2	13.6
3	120	8.4	0.96	1.36	3.1	17.1
3	150	10.5	1.04	1.32	3.1	21.4
3	185	12.95	1.12	1.29	3.0	26.4
3	240	16.8	1.24	1.26	2.9	34.3
3	300	21	1.32	1.24	2.9	42.8
3	400	28	1.48	1.22	2.8	56.9
3	500	35	1.64	1.21	2.7	71.5



OUR CERTIFICATION
ISO 9001 | ISO 14001 | ISO 45001



OUR CERTIFICATION
ISO 9001 | ISO 14001 | ISO 45001



POLYCAB THREE CORE MV AS/NZS 1429.1 12.7/22 (24) KV
MV Cable with Aluminium Conductor, XLPE Insulation, Copper Screen and Unarmoured

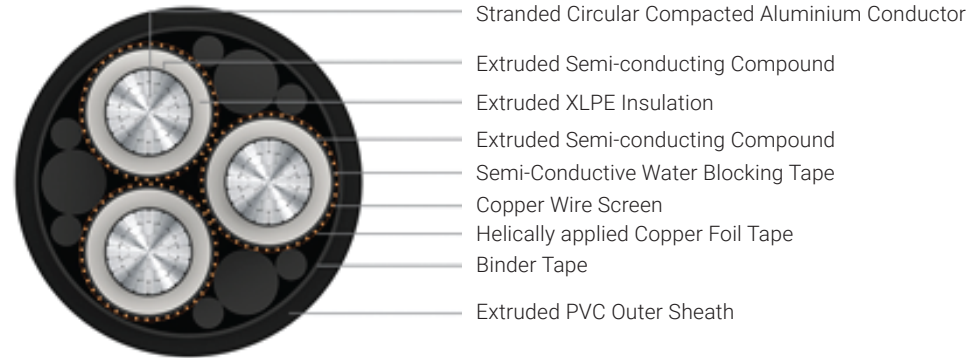

- Salient Features**
- Long life
 - UV resistant
 - Resistant to chemical exposure
 - Resistant to water (AD7/AD8 with HDPE)
 - Resistant to weather exposure

Application
POLYCAB MV 12.7/22 KV XLPE insulated with Aluminium conductor Three core cable is suitable to use for power supply to wide networks i.e. Commercial, Industrial and Urban / Residential.

Voltage Rating
Nominal Voltage: 12.7/22 (24) kV

Operation Temperature
Min. installation temperature: 0°C
Operating temperature: -25°C to +90°C
Emergency operating temperature: 105°C
(max. operation of 36hrs, at 3 periods for 12 consecutive months use)
Max. Short Circuit Temperature: 250°C

- Construction**
- Conductor: Stranded Compacted Circular aluminium conductor as per AS/NZS 1125
 - Conductor Screen: Extruded Semi-conductive compound
 - Insulation: XLPE
 - Insulation Screen: Extruded Strippable Semi-conductive compound
 - Longitudinal Water blocking : Water blocking tape above and below copper screen (Optional)
 - Metallic Insulation Screen: Copper Wire Screen + helically applied copper tape
 - binder tape / sheath over assembled cores
 - Metallic Sheath: Lead Alloy (optional)
 - Outer Sheath: Extruded Polyvinyl Chloride, Colour: Black
 - Insect attack Protection: Polyamide Nylon (optional)
(Alternative Sheath: PVC + HDPE Outer Sheath or LSZH Outer sheath and parameters will change accordingly)

Bending Radius:
Fixed Installation: 12D (PVC) / 15D (HDPE)
During Installation: 18D (PVC) / 25D (HDPE)

D is overall diameter of cable

Standard and References:
AS/NZS 1429.1
AS/NZS 1125
AS/NZS 3808

High Voltage Test (kV AC)	Partial discharge test (kV AC)		Impulse test Voltage (kV peak)
	200% to rated voltage	150% to rated voltage	
45	25	19	150

- Compliance**
- Conductor resistance AS/NZS 1125
 - Insulation resistance AS/NZS 1429.1
 - Voltage test AS/NZS 1429.1



POLYCAB THREE CORE MV AS/NZS 1429.1 12.7/22 (24) KV
MV Cable with Aluminium Conductor, XLPE Insulation, Copper Screen and Unarmoured

DIMENSIONAL CHARACTERISTICS:



Product Code	No. of Cores	Core Cross sectional Area	Nominal Diameter		
			Under metallic screen	Over metallic screen	Overall
	No.	mm ²	mm	mm	mm
MVNZ12AXUAPH003C035SAXXXX	3	35	21.1	22.6	54.0
MVNZ12AXUAPH003C050SAXXXX	3	50	22.2	23.7	57.0
MVNZ12AXUAPH003C070SAXXXX	3	70	23.8	25.3	60.0
MVNZ12AXUAPH003C095SAXXXX	3	95	25.4	26.9	64.0
MVNZ12AXUAPH003C120SAXXXX	3	120	27	28.5	67.0
MVNZ12AXUAPH003C150SAXXXX	3	150	28.3	29.8	70.0
MVNZ12AXUAPH003C185SAXXXX	3	185	30	31.5	74.0
MVNZ12AXUAPH003C240SAXXXX	3	240	32.3	33.8	80.0
MVNZ12AXUAPH003C300SAXXXX	3	300	34.5	36.0	85.0
MVNZ12AXUAPH003C400SAXXXX	3	400	37.2	38.7	91.0
MVNZ12AXUAPH003C500SAXXXX	3	500	40.6	42.1	99.0

- Above mentioned parameters are based on 3kA/sec earth fault current capacity of copper screen



POLYCAB THREE CORE MV AS/NZS 1429.1 12.7/22 (24) KV
MV Cable with Aluminium Conductor, XLPE Insulation, Copper Screen and Unarmoured

ELECTRICAL CHARACTERISTICS:

No. of Cores	Core Cross sectional Area	Max. DC Resistance at 20°C	Max. AC Resistance at 90°C	Approx. Capacitance	Approx. Inductance	Approx. Reactance	Continuous Current Rating		
							Buried direct in ground	In a buried duct	In Air
									
No.	mm ²	Ω/km	Ω/km	μF/km	mH/km	Ω/km	Amps		
3	35	0.868	1.113	0.16	0.625	0.196	119	103	132
3	50	0.641	0.822	0.17	0.604	0.190	140	122	158
3	70	0.443	0.568	0.2	0.571	0.179	171	150	196
3	95	0.32	0.410	0.22	0.551	0.173	203	179	236
3	120	0.253	0.325	0.24	0.533	0.167	232	205	273
3	150	0.206	0.264	0.25	0.522	0.164	260	231	309
3	185	0.164	0.211	0.28	0.510	0.160	294	262	355
3	240	0.125	0.161	0.31	0.496	0.156	340	305	415
3	300	0.1	0.129	0.33	0.484	0.152	384	346	475
3	400	0.0778	0.101	0.37	0.473	0.149	438	398	552
3	500	0.0605	0.079	0.41	0.462	0.145	505	460	646

: Current ratings are in accordance with IEC 60502-2: Current Ratings are based on IEC 60502-2 & IEC 60287, Max. Conductor Temperature at 90°C, Ambient temperature at 30°C in Air / at 20°C in Ground, Thermal resistivity of Soil 1.5 k.m/W & for earthenware ducts 1.2k.m/W and Depth of Laying 0.8m.

Current rating de-rating factors for other than 30°C ambient air temperature.

20	25	35	40	45	50	55	60
1.08	1.04	0.96	0.91	0.87	0.82	0.76	0.71

Current rating de-rating factors for other than 20°C ground temperature.

10	15	25	30	35	40	45	50
1.07	1.04	0.96	0.93	0.89	0.85	0.80	0.76

POLYCAB THREE CORE MV AS/NZS 1429.1 12.7/22 (24) KV
MV Cable with Aluminium Conductor, XLPE Insulation, Copper Screen and Unarmoured

No. of Cores	Core Cross sectional Area	Max. pulling tension on conductor	Charging Current per phase	Zero sequence impedance	Electric Stress at Conductor Screen	Short circuit rating of Phase conductor
No.	mm ²	kN	Amps/Km	Ohms/Km	kV/mm	kA, 1 sec
3	35	1.75	0.64	2.27	3.7	3.1
3	50	2.5	0.68	1.98	3.5	4.5
3	70	3.5	0.8	1.73	3.4	6.2
3	95	4.75	0.88	1.57	3.2	8.5
3	120	6	0.96	1.49	3.1	10.7
3	150	7.5	1	1.43	3.1	13.4
3	185	9.25	1.12	1.37	3.0	16.5
3	240	12	1.24	1.32	2.9	21.4
3	300	15	1.32	1.29	2.9	26.8
3	400	20	1.48	1.26	2.8	35.5
3	500	25	1.64	1.24	2.7	44.7



OUR CERTIFICATION
ISO 9001 | ISO 14001 | ISO 45001



OUR CERTIFICATION
ISO 9001 | ISO 14001 | ISO 45001



POLYCAB THREE CORE ANTI-TERMITE MV AS/NZS 1429.1 12.7/22 (24) KV
MV Cable with Aluminium Conductor, XLPE Insulation, Copper Screen and Unarmoured



- Stranded Circular Compacted Aluminium Conductor
- Extruded Semi-conducting Compound
- Extruded XLPE Inner Sheath
- Extruded Semi-conducting Compound
- Semi-Conductive Water Blocking Tape (optional)
- Copper Wire Screen
- Helically applied Copper Foil Tape
- Binder Tape
- Extruded PVC Inner layer
- Polyamide (Nylon-12) Anti-Termite layer
- Extruded HDPE Outer Sheath

Salient Features

- Long life
- UV resistant
- Resistant to chemical exposure
- Resistant to weather exposure
- Resistant to water (AD7/AD8)
- Termite resistant

Application

POLYCAB MV 12.7/22 KV XLPE insulated with Aluminium conductor Three core cable is suitable to use for power supply to wide networks i.e. Commercial, Industrial and Urban / Residential.

Voltage Rating

Nominal Voltage: 12.7/22 (24) kV

Operation Temperature

Min. installation temperature: 0°C
 Operating temperature: -25°C to +90°C
 Emergency operating temperature: 105°C
 (max. operation of 36hrs, at 3 periods for 12 consecutive months use)
 Max. Short Circuit Temperature: 250°C

Construction

- Conductor: Stranded Compacted Circular aluminium conductor as per AS/NZS 1125
- Conductor Screen: Extruded Semi-conductive compound
- Insulation: XLPE
- Insulation Screen: Extruded Semi-conductive compound
- Longitudinal Water blocking : Water blocking tape above and below copper screen (Optional)
- Metallic Insulation Screen: Copper Wire Screen + helically applied copper tape
- binder tape / sheath over assembled cores

Composite sheath

- Inner layer : Extruded Polyvinyl Chloride, Colour: Orange
- Termite Protection: Polyamide (Nylon -12)
- Outer layer: HDPE (Black)

Bending Radius:

Fixed Installation: 20D
 During Installation: 30D

D is diameter over nylon

Standard and References:

AS/NZS 1429.1
 AS/NZS 1125
 AS/NZS 3808

High Voltage Test (kV AC)	Partial discharge test (kV AC)		Impulse test Voltage (kV peak)
	200% to rated voltage	150% to rated voltage	
45	25	19	150

Compliance

- Conductor resistance AS/NZS 1125
- Insulation resistance AS/NZS 1429.1
- Voltage test AS/NZS 1429.1



POLYCAB THREE CORE ANTI-TERMITE MV AS/NZS 1429.1 12.7/22 (24) KV
MV Cable with Aluminium Conductor, XLPE Insulation, Copper Screen and Unarmoured



DIMENSIONAL CHARACTERISTICS:

Product Code	No. of Cores	Core Cross sectional Area	Nominal Diameter		
			Under metallic screen	Over metallic screen	Overall
	No.	mm ²	mm	mm	mm
MVNZ12AXUAPH003C035SAXXXX	3	35	21.1	22.6	54.0
MVNZ12AXUAPH003C050SAXXXX	3	50	22.2	23.7	57.0
MVNZ12AXUAPH003C070SAXXXX	3	70	23.8	25.3	61.0
MVNZ12AXUAPH003C095SAXXXX	3	95	25.4	26.9	64.0
MVNZ12AXUAPH003C120SAXXXX	3	120	27	28.5	68.0
MVNZ12AXUAPH003C150SAXXXX	3	150	28.3	29.8	71.0
MVNZ12AXUAPH003C185SAXXXX	3	185	30	31.5	75.0
MVNZ12AXUAPH003C240SAXXXX	3	240	32.3	33.8	80.0
MVNZ12AXUAPH003C300SAXXXX	3	300	34.5	36.0	85.0
MVNZ12AXUAPH003C400SAXXXX	3	400	37.2	38.7	91.0
MVNZ12AXUAPH003C500SAXXXX	3	500	40.6	42.1	99.0

- Above mentioned parameters are based on 3kA/sec earth fault current capacity of copper screen



ELECTRICAL CHARACTERISTICS:

No. of Cores	Core Cross sectional Area	Max. DC Resistance at 20°C	Max. AC Resistance at 90°C	Approx. Capacitance	Approx. Inductance	Approx. Reactance	Continuous Current Rating		
							Buried direct in ground	In a buried duct	In Air
									
No.	mm ²	Ω/km	Ω/km	μF/km	mH/km	Ω/km	Amps		
3	35	0.868	1.113	0.16	0.627	0.197	119	103	132
3	50	0.641	0.822	0.17	0.605	0.190	140	122	158
3	70	0.443	0.568	0.2	0.572	0.180	171	150	196
3	95	0.32	0.410	0.22	0.552	0.174	203	179	236
3	120	0.253	0.325	0.24	0.534	0.168	232	205	273
3	150	0.206	0.264	0.25	0.523	0.164	260	231	309
3	185	0.164	0.211	0.28	0.511	0.161	294	262	355
3	240	0.125	0.161	0.31	0.498	0.156	340	305	415
3	300	0.1	0.129	0.33	0.485	0.152	384	346	475
3	400	0.0778	0.101	0.37	0.474	0.149	438	398	552
3	500	0.0605	0.079	0.41	0.463	0.145	505	460	646

: Current ratings are in accordance with IEC 60502-2: Current Ratings are based on IEC 60502-2 & IEC 60287, Max. Conductor Temperature at 90°C, Ambient temperature at 30°C in Air / at 20°C in Ground, Thermal resistivity of Soil 1.5 k.m/W & for earthenware ducts 1.2k.m/W and Depth of Laying 0.8m.

Current rating de-rating factors for other than 30°C ambient air temperature.

20	25	35	40	45	50	55	60
1.08	1.04	0.96	0.91	0.87	0.82	0.76	0.71

Current rating de-rating factors for other than 20°C ground temperature.

10	15	25	30	35	40	45	50
1.07	1.04	0.96	0.93	0.89	0.85	0.80	0.76

No. of Cores	Core Cross sectional Area	Max. pulling tension on conductor	Charging Current per phase	Zero sequence impedance	Electric Stress at Conductor Screen	Short circuit rating of Phase conductor
No.	mm ²	kN	Amps/Km	Ohms/Km	kV/mm	kA, 1 sec
3	35	1.75	0.64	2.27	3.7	3.1
3	50	2.5	0.68	1.98	3.5	4.5
3	70	3.5	0.8	1.73	3.4	6.2
3	95	4.75	0.88	1.57	3.2	8.5
3	120	6	0.96	1.49	3.1	10.7
3	150	7.5	1	1.43	3.1	13.4
3	185	9.25	1.12	1.37	3.0	16.5
3	240	12	1.24	1.32	2.9	21.4
3	300	15	1.32	1.29	2.9	26.8
3	400	20	1.48	1.26	2.8	35.5
3	500	25	1.64	1.24	2.7	44.7



OUR CERTIFICATION
 ISO 9001 | ISO 14001 | ISO 45001



OUR CERTIFICATION
 ISO 9001 | ISO 14001 | ISO 45001



POLYCAB THREE CORE MV AS/NZS 1429.1 19/33 (36) KV
MV Cable with Copper Conductor, XLPE Insulation, Copper Screen and Unarmoured

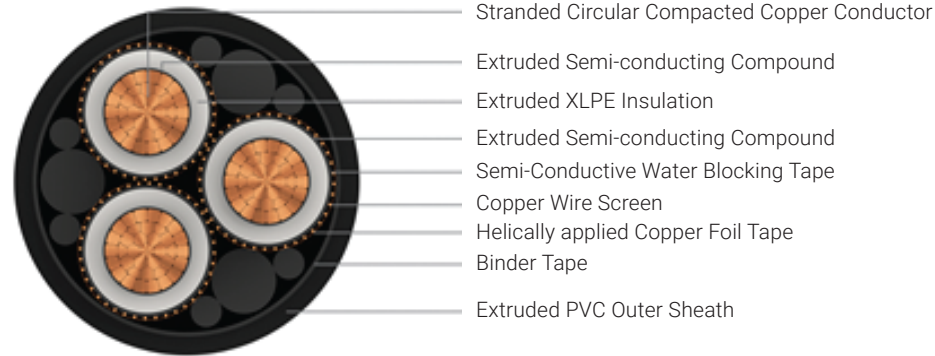

- Salient Features**
- Long life
 - UV resistant
 - Resistant to chemical exposure
 - Resistant to water (AD7/AD8 with HDPE)
 - Resistant to weather exposure
 - Termite resistant (Optional)

Application
POLYCAB MV 19/33 KV XLPE insulated with Copper conductor Three core cable is suitable to use for power supply to wide networks i.e. Commercial, Industrial and Urban / Residential.

Voltage Rating
Nominal Voltage: 19/33 (36) kV

Operation Temperature
Min. installation temperature: 0°C
Operating temperature: -25°C to +90°C
Emergency operating temperature: 105°C
(max. operation of 36hrs, at 3 periods for 12 consecutive months use)
Max. Short Circuit Temperature: 250°C

- Construction**
- Conductor: Stranded Compacted Circular Copper conductor as per AS/NZS 1125
 - Conductor Screen: Extruded Semi-conductive compound
 - Insulation: XLPE
 - Insulation Screen: Extruded Semi-conductive compound
 - Longitudinal Water blocking : Water blocking tape below copper screen (Optional)
 - Metallic Insulation Screen: Copper Wire Screen + helically applied copper tape (E/F current capacity – Based on requirement)
 - binder tape / sheath over assembled cores
 - Metallic Sheath: Lead Alloy (optional)
 - Outer Sheath: Extruded Polyvinyl Chloride, Colour: Black
 - Insect attack Protection: Polyamide Nylon (optional)
(Alternative Sheath: PVC+HDPE Composite Sheath or PVC + Nylon + HDPE (composite sheath with anti-termite properties) or LSZH Outer sheath, and parameters will change accordingly)

Bending Radius:
Fixed Installation: 12D (PVC) / 15D (HDPE) / 20D (Nylon)
During Installation: 18D (PVC) / 25D (HDPE) / 30D (Nylon)

D is overall diameter of cable

Standard and References:
AS/NZS 1429.1
AS/NZS 1125
AS/NZS 3808

High Voltage Test (kV AC)	Partial discharge test (kV AC)		Impulse test Voltage (kV peak)
	200% to rated voltage	150% to rated voltage	
65	38	29	200

- Compliance**
- Conductor resistance AS/NZS 1125
 - Insulation resistance AS/NZS 1429.1
 - Voltage test AS/NZS 1429.1



POLYCAB THREE CORE MV AS/NZS 1429.1 19/33 (36) KV
MV Cable with Copper Conductor, XLPE Insulation, Copper Screen and Unarmoured

DIMENSIONAL CHARACTERISTICS:



Product Code	No. of Cores	Core Cross sectional Area	Nominal Diameter		
			Under metallic screen	Over metallic screen	Overall
	No.	mm ²	mm	mm	mm
MVNZ13CXUAPH003C050SAXXXX	3	50	27.2	28.7	68.0
MVNZ13CXUAPH003C070SAXXXX	3	70	28.9	30.4	72.0
MVNZ13CXUAPH003C095SAXXXX	3	95	30.4	31.9	75.0
MVNZ13CXUAPH003C120SAXXXX	3	120	32	33.5	79.0
MVNZ13CXUAPH003C150SAXXXX	3	150	33.4	34.9	82.0
MVNZ13CXUAPH003C185SAXXXX	3	185	35.1	36.6	86.0
MVNZ13CXUAPH003C240SAXXXX	3	240	37.4	38.9	91.0
MVNZ13CXUAPH003C300SAXXXX	3	300	39.4	40.9	96.0
MVNZ13CXUAPH003C400SAXXXX	3	400	42.2	43.7	102.0
MVNZ13CXUAPH003C500SAXXXX	3	500	45.6	47.1	110.0

- Above mentioned parameters are based on 3kA/sec earth fault current capacity of copper screen



POLYCAB THREE CORE MV AS/NZS 1429.1 19/33 (36) KV
MV Cable with Copper Conductor, XLPE Insulation, Copper Screen and Unarmoured

ELECTRICAL CHARACTERISTICS:

No. of Cores	Core Cross sectional Area	Max. DC Resistance at 20°C	Max. AC Resistance at 90°C	Approx. Capacitance	Approx. Inductance	Approx. Reactance	Continuous Current Rating		
							Buried direct in ground	In a buried duct	In Air
									
No.	mm ²	Ω/km	Ω/km	μF/km	mH/km	Ω/km	Amps		
3	50	0.387	0.494	0.14	0.642	0.202	181	158	204
3	70	0.268	0.342	0.15	0.605	0.190	221	193	253
3	95	0.193	0.246	0.17	0.585	0.184	262	231	304
3	120	0.153	0.196	0.18	0.565	0.178	298	264	351
3	150	0.124	0.159	0.19	0.552	0.173	334	297	398
3	185	0.0991	0.127	0.21	0.539	0.169	377	336	455
3	240	0.0754	0.097	0.23	0.523	0.164	434	390	531
3	300	0.0601	0.078	0.25	0.510	0.160	489	441	606
3	400	0.047	0.062	0.27	0.497	0.156	553	501	696
3	500	0.0366	0.049	0.3	0.484	0.152	632	574	800

: Current ratings are in accordance with IEC 60502-2: Current Ratings are based on IEC 60502-2 & IEC 60287, Max. Conductor Temperature at 90°C, Ambient temperature at 30°C in Air / at 20°C in Ground, Thermal resistivity of Soil 1.5 k.m/W & for earthenware ducts 1.2k.m/W and Depth of Laying 0.8m.

Current rating de-rating factors for other than 30°C ambient air temperature.

20	25	35	40	45	50	55	60
1.08	1.04	0.96	0.91	0.87	0.82	0.76	0.71

Current rating de-rating factors for other than 20°C ground temperature.

10	15	25	30	35	40	45	50
1.07	1.04	0.96	0.93	0.89	0.85	0.80	0.76

POLYCAB THREE CORE MV AS/NZS 1429.1 19/33 (36) KV
MV Cable with Copper Conductor, XLPE Insulation, Copper Screen and Unarmoured

No. of Cores	Core Cross sectional Area	Max. pulling tension on conductor	Charging Current per phase	Zero sequence impedance	Electric Stress at Conductor Screen	Short circuit rating of Phase conductor
No.	mm ²	kN	Amps/Km	Ohms/Km	kV/mm	kA, 1 sec
3	50	3.5	0.84	1.66	4.1	7.2
3	70	4.9	0.9	1.50	3.9	10.0
3	95	6.65	1.01	1.41	3.7	13.6
3	120	8.4	1.07	1.36	3.6	17.1
3	150	10.5	1.13	1.32	3.5	21.4
3	185	12.95	1.25	1.29	3.4	26.4
3	240	16.8	1.37	1.26	3.3	34.3
3	300	21	1.49	1.24	3.2	42.8
3	400	28	1.61	1.22	3.1	56.9
3	500	35	1.79	1.21	3.0	71.5



OUR CERTIFICATION
 ISO 9001 | ISO 14001 | ISO 45001



OUR CERTIFICATION
 ISO 9001 | ISO 14001 | ISO 45001



POLYCAB THREE CORE MV AS/NZS 1429.1 19/33 (36) KV
MV Cable with Aluminium Conductor, XLPE Insulation, Copper Screen and Unarmoured

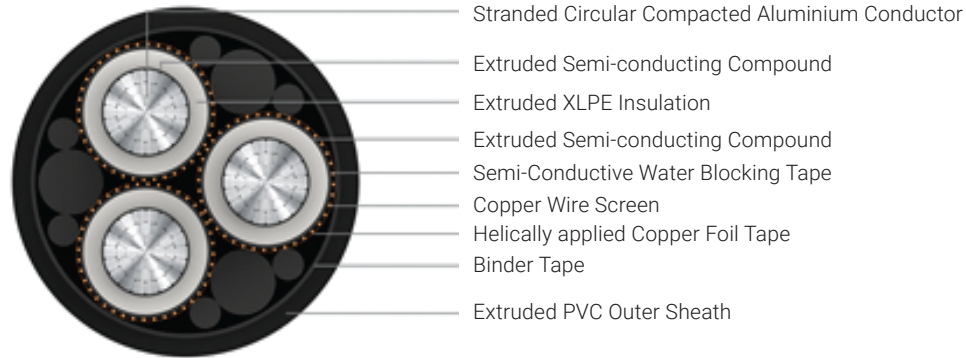

- Salient Features**
- Long life
 - UV resistant
 - Resistant to chemical exposure
 - Resistant to water (AD7/AD8 with HDPE)
 - Resistant to weather exposure

Application
POLYCAB MV 19/33 KV XLPE insulated with Aluminium conductor Three core cable is suitable to use for power supply to wide networks i.e. Commercial, Industrial and Urban / Residential.

Voltage Rating
Nominal Voltage: 19/33 (36) kV

Operation Temperature
Min. installation temperature: 0°C
Operating temperature: -25°C to +90°C
Emergency operating temperature: 105°C
(max. operation of 36hrs, at 3 periods for 12 consecutive months use)
Max. Short Circuit Temperature: 250°C

- Construction**
- Conductor: Stranded Compacted Circular aluminium conductor as per AS/NZS 1125
 - Conductor Screen: Extruded Semi-conductive compound
 - Insulation: XLPE
 - Insulation Screen: Extruded Strippable Semi-conductive compound
 - Longitudinal Water blocking : Water blocking tape above and below copper screen (Optional)
 - Metallic Insulation Screen: Copper Wire Screen + helicly applied copper tape
 - binder tape / sheath over assembled cores
 - Metallic Sheath: Lead Alloy (optional)
 - Outer Sheath: Extruded Polyvinyl Chloride, Colour: Black
 - Insect attack Protection: Polyamide Nylon (optional)
(Alternative Sheath: PVC + HDPE Outer Sheath or LSZH Outer sheath and parameters will change accordingly)

Bending Radius:
Fixed Installation: 12D (PVC) / 15D (HDPE)
During Installation: 18D (PVC) / 25D (HDPE)

D is overall diameter of cable

Standard and References:
AS/NZS 1429.1
AS/NZS 1125
AS/NZS 3808

High Voltage Test (kV AC)	Partial discharge test (kV AC)		Impulse test Voltage (kV peak)
	200% to rated voltage	150% to rated voltage	
63	38	29	200

- Compliance**
- Conductor resistance AS/NZS 1125
 - Insulation resistance AS/NZS 1429.1
 - Voltage test AS/NZS 1429.1



POLYCAB THREE CORE MV AS/NZS 1429.1 19/33 (36) KV
MV Cable with Aluminium Conductor, XLPE Insulation, Copper Screen and Unarmoured

DIMENSIONAL CHARACTERISTICS:

Product Code	No. of Cores	Core Cross sectional Area	Nominal Diameter		
			Under metallic screen	Over metallic screen	Overall
	No.	mm ²	mm	mm	mm
MVNZ13AXUAPH003C050SAXXXX	3	50	27.2	28.7	68.0
MVNZ13AXUAPH003C070SAXXXX	3	70	28.8	30.3	72.0
MVNZ13AXUAPH003C095SAXXXX	3	95	30.4	31.9	75.0
MVNZ13AXUAPH003C120SAXXXX	3	120	32	33.5	79.0
MVNZ13AXUAPH003C150SAXXXX	3	150	33.3	34.8	82.0
MVNZ13AXUAPH003C185SAXXXX	3	185	35	36.5	86.0
MVNZ13AXUAPH003C240SAXXXX	3	240	37.3	38.8	91.0
MVNZ13AXUAPH003C300SAXXXX	3	300	39.5	41.0	96.0
MVNZ13AXUAPH003C400SAXXXX	3	400	42.2	43.7	102.0
MVNZ13AXUAPH003C500SAXXXX	3	500	45.6	47.1	110.0

- Above mentioned parameters are based on 3kA/sec earth fault current capacity of copper screen



OUR CERTIFICATION
ISO 9001 | ISO 14001 | ISO 45001





OUR CERTIFICATION
ISO 9001 | ISO 14001 | ISO 45001



POLYCAB THREE CORE MV AS/NZS 1429.1 19/33 (36) KV
MV Cable with Aluminium Conductor, XLPE Insulation, Copper Screen and Unarmoured

ELECTRICAL CHARACTERISTICS:

No. of Cores	Core Cross sectional Area	Max. DC Resistance at 20°C	Max. AC Resistance at 90°C	Approx. Capacitance	Approx. Inductance	Approx. Reactance	Continuous Current Rating		
							Buried direct in ground	In a buried duct	In Air
									
No.	mm ²	Ω/km	Ω/km	μF/km	mH/km	Ω/km	Amps		
3	50	0.641	0.822	0.14	0.642	0.202	140	122	158
3	70	0.443	0.568	0.15	0.607	0.191	171	150	196
3	95	0.32	0.410	0.17	0.585	0.184	203	179	236
3	120	0.253	0.325	0.18	0.565	0.178	232	205	273
3	150	0.206	0.264	0.19	0.553	0.174	260	231	309
3	185	0.164	0.211	0.21	0.539	0.169	294	262	355
3	240	0.125	0.161	0.23	0.524	0.165	340	305	415
3	300	0.1	0.129	0.25	0.510	0.160	384	346	475
3	400	0.0778	0.101	0.27	0.497	0.156	438	398	552
3	500	0.0605	0.079	0.3	0.484	0.152	505	460	646

: Current ratings are in accordance with IEC 60502-2: Current Ratings are based on IEC 60502-2 & IEC 60287, Max. Conductor Temperature at 90°C, Ambient temperature at 30°C in Air / at 20°C in Ground, Thermal resistivity of Soil 1.5 k.m/W & for earthenware ducts 1.2k.m/W and Depth of Laying 0.8m.

Current rating de-rating factors for other than 30°C ambient air temperature.

20	25	35	40	45	50	55	60
1.08	1.04	0.96	0.91	0.87	0.82	0.76	0.71

Current rating de-rating factors for other than 20°C ground temperature.

10	15	25	30	35	40	45	50
1.07	1.04	0.96	0.93	0.89	0.85	0.80	0.76

POLYCAB THREE CORE MV AS/NZS 1429.1 19/33 (36) KV
MV Cable with Aluminium Conductor, XLPE Insulation, Copper Screen and Unarmoured

No. of Cores	Core Cross sectional Area	Max. pulling tension on conductor	Charging Current per phase	Zero sequence impedance	Electric Stress at Conductor Screen	Short circuit rating of Phase conductor
No.	mm ²	kN	Amps/Km	Ohms/Km	kV/mm	kA, 1 sec
3	50	2.5	0.84	1.98	4.1	4.5
3	70	3.5	0.9	1.73	3.9	6.2
3	95	4.75	1.01	1.57	3.7	8.5
3	120	6	1.07	1.49	3.6	10.7
3	150	7.5	1.13	1.43	3.5	13.4
3	185	9.25	1.25	1.37	3.4	16.5
3	240	12	1.37	1.32	3.3	21.4
3	300	15	1.49	1.29	3.2	26.8
3	400	20	1.61	1.26	3.1	35.5
3	500	25	1.79	1.24	3.0	44.7



OUR CERTIFICATION
 ISO 9001 | ISO 14001 | ISO 45001



OUR CERTIFICATION
 ISO 9001 | ISO 14001 | ISO 45001



POLYCAB THREE CORE ANTI-TERMITE MV AS/NZS 1429.1 19/33 (36) KV
MV Cable with Aluminium Conductor, XLPE Insulation, Copper Screen and Unarmoured

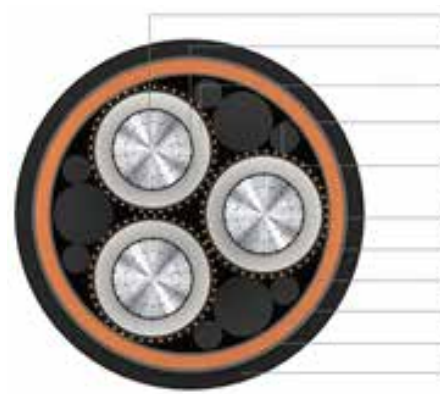

- Stranded Circular Compacted Aluminium Conductor
- Extruded Semi-conducting Compound
- Extruded XLPE Inner Sheath
- Extruded Semi-conducting Compound
- Semi-Conductive Water Blocking Tape (optional)
- Copper Wire Screen
- Helically applied Copper Foil Tape
- Binder Tape
- Extruded PVC Inner layer
- Polyamide (Nylon-12) Anti-Termite layer
- Extruded HDPE Outer Sheath

Salient Features

- Long life
- UV resistant
- Resistant to chemical exposure
- Resistant to weather exposure
- Resistant to water (AD7/AD8)
- Termite resistant

Application

POLYCAB MV 19/33 KV XLPE insulated with Aluminium conductor Three core cable is suitable to use for power supply to wide networks i.e. Commercial, Industrial and Urban / Residential.

Voltage Rating

Nominal Voltage: 19/33 (36) kV

Operation Temperature

Min. installation temperature: 0°C
 Operating temperature: -25°C to +90°C
 Emergency operating temperature: 105°C
 (max. operation of 36hrs, at 3 periods for 12 consecutive months use)
 Max. Short Circuit Temperature: 250°C

Bending Radius:

Fixed Installation: 20D
 During Installation: 30D

D is diameter over nylon

Standard and References:

AS/NZS 1429.1
 AS/NZS 1125
 AS/NZS 3808

Construction

- Conductor: Stranded Compacted Circular aluminium conductor as per AS/NZS 1125
- Conductor Screen: Extruded Semi-conductive compound
- Insulation: XLPE
- Insulation Screen: Extruded Semi-conductive compound
- Longitudinal Water blocking : Water blocking tape above and below copper screen (Optional)
- Metallic Insulation Screen: Copper Wire Screen + helically applied copper tape
- Binder tape / sheath over assembled cores

Composite sheath

- Inner layer : Extruded Polyvinyl Chloride, Colour: Orange
- Termite Protection: Polyamide (Nylon -12)
- Outer layer: HDPE (Black)

High Voltage Test (kV AC)	Partial discharge test (kV AC)		Impulse test Voltage (kV peak)
	200% to rated voltage	150% to rated voltage	
63	38	29	200

Compliance

- Conductor resistance AS/NZS 1125
- Insulation resistance AS/NZS 1429.1
- Voltage test AS/NZS 1429.1



POLYCAB THREE CORE ANTI-TERMITE MV AS/NZS 1429.1 19/33 (36) KV
MV Cable with Aluminium Conductor, XLPE Insulation, Copper Screen and Unarmoured

DIMENSIONAL CHARACTERISTICS:



Product Code	No. of Cores	Core Cross sectional Area	Nominal Diameter		
			Under metallic screen	Over metallic screen	Overall
	No.	mm ²	mm	mm	mm
MVNZ13AXUAPH003C050SAXXXX	3	50	27.2	28.7	68.0
MVNZ13AXUAPH003C070SAXXXX	3	70	28.8	30.3	72.0
MVNZ13AXUAPH003C095SAXXXX	3	95	30.4	31.9	76.0
MVNZ13AXUAPH003C120SAXXXX	3	120	32	33.5	80.0
MVNZ13AXUAPH003C150SAXXXX	3	150	33.3	34.8	82.0
MVNZ13AXUAPH003C185SAXXXX	3	185	35	36.5	86.0
MVNZ13AXUAPH003C240SAXXXX	3	240	37.3	38.8	92.0
MVNZ13AXUAPH003C300SAXXXX	3	300	39.5	41.0	96.0
MVNZ13AXUAPH003C400SAXXXX	3	400	42.2	43.7	103.0
MVNZ13AXUAPH003C500SAXXXX	3	500	45.6	47.1	110.0

- Above mentioned parameters are based on 3kA/sec earth fault current capacity of copper screen



POLYCAB THREE CORE ANTI-TERMITE MV AS/NZS 1429.1 19/33 (36) KV
MV Cable with Aluminium Conductor, XLPE Insulation, Copper Screen and Unarmoured

ELECTRICAL CHARACTERISTICS:

No. of Cores	Core Cross sectional Area	Max. DC Resistance at 20°C	Max. AC Resistance at 90°C	Approx. Capacitance	Approx. Inductance	Approx. Reactance	Continuous Current Rating		
							Buried direct in ground	In a buried duct	In Air
									
No.	mm ²	Ω/km	Ω/km	μF/km	mH/km	Ω/km	Amps		
3	50	0.641	0.822	0.14	0.643	0.202	140	122	158
3	70	0.443	0.568	0.15	0.608	0.191	171	150	196
3	95	0.32	0.410	0.17	0.586	0.184	203	179	236
3	120	0.253	0.325	0.18	0.567	0.178	232	205	273
3	150	0.206	0.264	0.19	0.554	0.174	260	231	309
3	185	0.164	0.211	0.21	0.541	0.170	294	262	355
3	240	0.125	0.161	0.23	0.525	0.165	340	305	415
3	300	0.1	0.129	0.25	0.511	0.160	384	346	475
3	400	0.0778	0.101	0.27	0.498	0.156	438	398	552
3	500	0.0605	0.079	0.3	0.485	0.152	505	460	646

: Current ratings are in accordance with IEC 60502-2: Current Ratings are based on IEC 60502-2 & IEC 60287, Max. Conductor Temperature at 90°C, Ambient temperature at 30°C in Air / at 20°C in Ground, Thermal resistivity of Soil 1.5 k.m/W & for earthenware ducts 1.2k.m/W and Depth of Laying 0.8m.

Current rating de-rating factors for other than 30°C ambient air temperature.

20	25	35	40	45	50	55	60
1.08	1.04	0.96	0.91	0.87	0.82	0.76	0.71

Current rating de-rating factors for other than 20°C ground temperature.

10	15	25	30	35	40	45	50
1.07	1.04	0.96	0.93	0.89	0.85	0.80	0.76

POLYCAB THREE CORE ANTI-TERMITE MV AS/NZS 1429.1 19/33 (36) KV
MV Cable with Aluminium Conductor, XLPE Insulation, Copper Screen and Unarmoured

No. of Cores	Core Cross sectional Area	Max. pulling tension on conductor	Charging Current per phase	Zero sequence impedance	Electric Stress at Conductor Screen	Short circuit rating of Phase conductor
No.	mm ²	kN	Amps/Km	Ohms/Km	kV/mm	kA, 1 sec
3	50	2.5	0.84	1.98	4.1	4.5
3	70	3.5	0.9	1.73	3.9	6.2
3	95	4.75	1.01	1.57	3.7	8.5
3	120	6	1.07	1.49	3.6	10.7
3	150	7.5	1.13	1.43	3.5	13.4
3	185	9.25	1.25	1.37	3.4	16.5
3	240	12	1.37	1.32	3.3	21.4
3	300	15	1.49	1.29	3.2	26.8
3	400	20	1.61	1.26	3.1	35.5
3	500	25	1.79	1.24	3.0	44.7



OUR CERTIFICATION
 ISO 9001 | ISO 14001 | ISO 45001



OUR CERTIFICATION
 ISO 9001 | ISO 14001 | ISO 45001



POLYCAB TRIPLEX MV AS/NZS 1429.1 3.8/6.6 (7.2) KV
MV Cable with Copper Conductor, XLPE Insulation, Copper Screen - Triplex

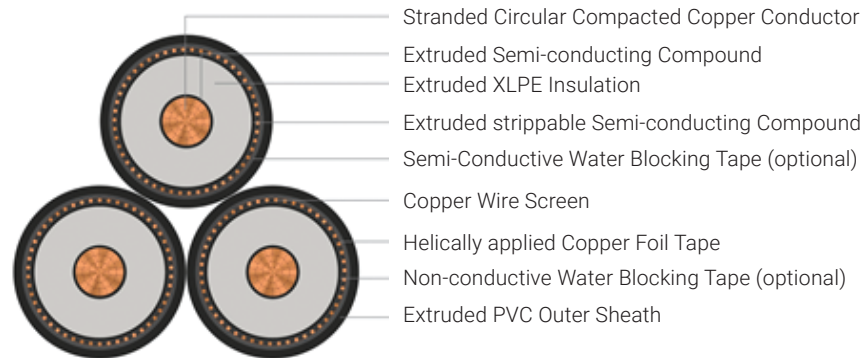

- Salient Features**
- Long life
 - UV resistant
 - Resistant to chemical exposure
 - Resistant to water (AD7/AD8 with HDPE)
 - Resistant to weather exposure
 - Termite resistant (Optional)

Application
POLYCAB MV 3.8/6.6 KV XLPE insulated with Copper conductor Triplex cable is suitable to use for power supply to wide networks i.e. Commercial, Industrial and Urban / Residential.

Voltage Rating
Nominal Voltage: 3.8/6.6 (7.2) kV

Operation Temperature
Min. installation temperature: 0°C
Operating temperature: -25°C to +90°C
Emergency operating temperature: 105°C
(max. operation of 36hrs, at 3 periods for 12 consecutive months use)
Max. Short Circuit Temperature: 250°C

Construction

- Conductor: Stranded Compacted Circular Copper conductor as per AS/NZS 1125
- Conductor Screen: Extruded Semi-conductive compound
- Insulation: XLPE
- Insulation Screen: Extruded Strippable Semi-conductive compound
- Longitudinal Water blocking : Water blocking tape above and below copper screen (Optional)
- Metallic Insulation Screen: Copper Wire Screen + helically applied copper tape (E/F current capacity – Based on requirement)
- Outer Sheath: Extruded Polyvinyl Chloride, Colour: Black
- Termite Protection: Polyamide (Nylon -12) (optional)
(Alternative Sheath: PVC+HDPE Composite Sheath or PVC + Nylon + HDPE (composite sheath with anti-termite properties) or LSZH Outer sheath, and parameters will change accordingly)

Three Single Core Cables twisted and assembled to form triplex formation

Bending Radius:
Fixed Installation: 12D (PVC) / 15D (HDPE) / 20D (Nylon)
During Installation: 18D (PVC) / 25D (HDPE) / 30D (Nylon)

D is overall diameter of each cable

Standard and References:
AS/NZS 1429.1
AS/NZS 1125
AS/NZS 3808

High Voltage Test (kV AC)	Partial discharge test (kV AC)		Impulse test Voltage (kV peak)
	200% to rated voltage	150% to rated voltage	
12.5	7.6	5.7	60

Compliance

- Conductor resistance AS/NZS 1125
- Insulation resistance AS/NZS 1429.1
- Short Circuit Temp. IEC 60986



POLYCAB TRIPLEX MV AS/NZS 1429.1 3.8/6.6 (7.2) KV
MV Cable with Copper Conductor, XLPE Insulation, Copper Screen - Triplex

DIMENSIONAL CHARACTERISTICS:

Product Code	No. of Cores	Core Cross sectional Area	Nominal Diameter		
			Under metallic screen	Over metallic screen	Overall
	No.	mm ²	mm	mm	mm
MVNZ15CXUAPH001T016SAXXXX	3	16	14.8	19.0	40.0
MVNZ15CXUAPH001T025SAXXXX	3	25	16.0	20.0	43.0
MVNZ15CXUAPH001T035SAXXXX	3	35	17.0	21.0	45.0
MVNZ15CXUAPH001T050SAXXXX	3	50	18.1	22.0	47.0
MVNZ15CXUAPH001T070SAXXXX	3	70	19.8	24.0	51.0
MVNZ15CXUAPH001T095SAXXXX	3	95	21.3	25.0	54.0
MVNZ15CXUAPH001T120SAXXXX	3	120	22.9	27.0	58.0
MVNZ15CXUAPH001T150SAXXXX	3	150	24.3	28.0	61.0
MVNZ15CXUAPH001T185SAXXXX	3	185	26.0	30.0	65.0
MVNZ15CXUAPH001T240SAXXXX	3	240	28.5	33.0	70.0
MVNZ15CXUAPH001T300SAXXXX	3	300	30.9	35.0	76.0
MVNZ15CXUAPH001T400SAXXXX	3	400	34.1	39.0	83.0
MVNZ15CXUAPH001T500SAXXXX	3	500	37.9	43.0	92.0

• Above mentioned parameters are based on 3kA/sec earth fault current capacity of copper screen



OUR CERTIFICATION
ISO 9001 | ISO 14001 | ISO 45001





OUR CERTIFICATION
ISO 9001 | ISO 14001 | ISO 45001



POLYCAB TRIPLEX MV AS/NZS 1429.1 3.8/6.6 (7.2) KV
 MV Cable with Copper Conductor, XLPE Insulation, Copper Screen - Triplex

ELECTRICAL CHARACTERISTICS:

No. of Cores	Core Cross sectional Area	Max. DC Resistance at 20°C	Max. AC Resistance at 90°C	Approx. Capacitance	Approx. Inductance	Approx. Reactance	Continuous Current Rating		
							Buried direct in ground	In a buried duct	In Air
									
No.	mm ²	Ω/km	Ω/km	μF/km	mH/km	Ω/km	Amps		
3 x 1	16	1.15	1.466	0.22	0.475	0.149	101	87	109
3 x 1	25	0.727	0.927	0.25	0.442	0.139	129	112	142
3 x 1	35	0.524	0.668	0.28	0.421	0.132	153	133	170
3 x 1	50	0.387	0.494	0.31	0.401	0.126	181	158	204
3 x 1	70	0.268	0.342	0.36	0.369	0.116	221	193	253
3 x 1	95	0.193	0.247	0.4	0.353	0.111	262	231	304
3 x 1	120	0.153	0.196	0.45	0.336	0.106	298	264	351
3 x 1	150	0.124	0.159	0.49	0.326	0.102	334	297	398
3 x 1	185	0.0991	0.128	0.54	0.316	0.099	377	336	455
3 x 1	240	0.0754	0.098	0.58	0.305	0.096	434	390	531
3 x 1	300	0.0601	0.079	0.59	0.299	0.094	489	441	606
3 x 1	400	0.047	0.063	0.62	0.291	0.091	553	501	696
3 x 1	500	0.0366	0.051	0.66	0.284	0.089	632	574	800

: Current ratings are in accordance with IEC 60502-2: Current Ratings are based on IEC 60502-2 & IEC 60287, Max. Conductor Temperature at 90°C, Ambient temperature at 30°C in Air / at 20°C in Ground, Thermal resistivity of Soil 1.5 k.m/W & for earthenware ducts 1.2k.m/W and Depth of Laying 0.8m.

Current rating de-rating factors for other than 30°C ambient air temperature.

20	25	35	40	45	50	55	60
1.08	1.04	0.96	0.91	0.87	0.82	0.76	0.71

Current rating de-rating factors for other than 20°C ground temperature.

10	15	25	30	35	40	45	50
1.07	1.04	0.96	0.93	0.89	0.85	0.80	0.76

POLYCAB TRIPLEX MV AS/NZS 1429.1 3.8/6.6 (7.2) KV
 MV Cable with Copper Conductor, XLPE Insulation, Copper Screen - Triplex

No. of Cores	Core Cross sectional Area	Max. pulling tension on conductor	Charging Current per phase	Zero sequence impedance	Electric Stress at Conductor Screen	Short circuit rating of Phase conductor
No.	mm ²	kN	Amps/Km	Ohms/Km	kV/mm	kA, 1 sec
3 x 1	16	1.1	0.26	2.6	2.1	2.3
3 x 1	25	1.8	0.3	2.1	2.0	3.6
3 x 1	35	2.5	0.33	1.8	2.0	5.0
3 x 1	50	3.5	0.37	1.7	1.9	7.2
3 x 1	70	4.9	0.43	1.5	1.9	10.0
3 x 1	95	6.7	0.48	1.4	1.8	13.6
3 x 1	120	8.4	0.54	1.4	1.8	17.1
3 x 1	150	10.5	0.58	1.3	1.8	21.4
3 x 1	185	13.0	0.64	1.3	1.7	26.4
3 x 1	240	16.8	0.69	1.3	1.7	34.3
3 x 1	300	21.0	0.7	1.2	1.5	42.8
3 x 1	400	28.0	0.74	1.2	1.4	56.9
3 x 1	500	35.0	0.79	1.2	1.3	71.5



OUR CERTIFICATION
 ISO 9001 | ISO 14001 | ISO 45001



OUR CERTIFICATION
 ISO 9001 | ISO 14001 | ISO 45001



POLYCAB TRIPLEX MV AS/NZS 1429.1 3.8/6.6 (7.2) KV
MV Cable with Aluminium Conductor, XLPE Insulation, Copper Screen - Triplex

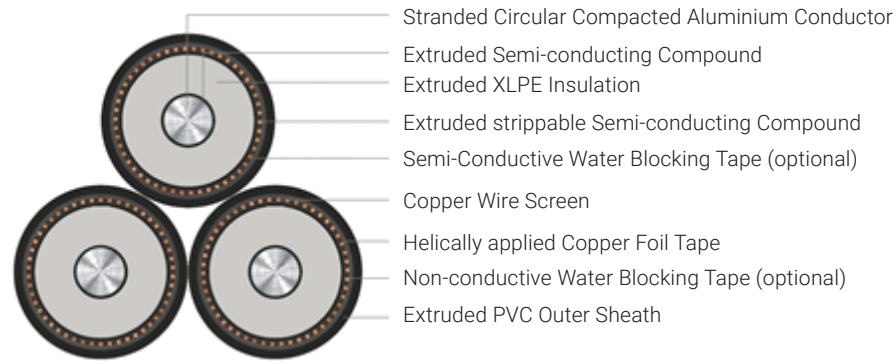

- Salient Features**
- Long life
 - UV resistant
 - Resistant to chemical exposure
 - Resistant to water (AD7/AD8 with HDPE)
 - Resistant to weather exposure

Application

POLYCAB MV 3.8/6.6 KV XLPE insulated with Aluminium conductor Triplex cable is suitable to use for power supply to wide networks i.e. Commercial, Industrial and Urban / Residential.

Voltage Rating

Nominal Voltage: 3.8/6.6 (7.2) kV

Operation Temperature

Min. installation temperature: 0°C
 Operating temperature: -25°C to +90°C
 Emergency operating temperature: 105°C
 (max. operation of 36hrs, at 3 periods for 12 consecutive months use)
 Max. Short Circuit Temperature: 250°C

Construction

- Conductor: Stranded Compacted Circular aluminium conductor as per AS/NZS 1125
- Conductor Screen: Extruded Semi-conductive compound
- Insulation: XLPE
- Insulation Screen: Extruded Strippable Semi-conductive compound
- Longitudinal Water blocking : Water blocking tape above and below copper screen (Optional)
- Metallic Insulation Screen: Copper Wire Screen + helically applied copper tape (E/F current capacity – Based on requirement)
- Outer Sheath: Extruded Polyvinyl Chloride, Colour: Black
- Termite Protection: Polyamide (Nylon -12) (optional)
 (Alternative Sheath: PVC+HDPE Composite Sheath or LSZH Outer sheath, and parameters will change accordingly)
 Three Single Core Cables twisted and assembled to form triplex formation

Bending Radius:

Fixed Installation: 12D (PVC) / 15D (HDPE)
 During Installation: 18D (PVC) / 25D (HDPE)

D is overall diameter of each cable

Standard and References:

AS/NZS 1429.1
 AS/NZS 1125
 AS/NZS 3808

High Voltage Test (kV AC)	Partial discharge test (kV AC)		Impulse test Voltage (kV peak)
	200% to rated voltage	150% to rated voltage	
12.5	7.6	5.7	60

Compliance

- Conductor resistance AS/NZS 1125
- Insulation resistance AS/NZS 1429.1
- Voltage test AS/NZS 1429.1



POLYCAB TRIPLEX MV AS/NZS 1429.1 3.8/6.6 (7.2) KV
MV Cable with Aluminium Conductor, XLPE Insulation, Copper Screen - Triplex

DIMENSIONAL CHARACTERISTICS:



Product Code	No. of Cores	Core Cross sectional Area	Nominal Diameter		
			Under metallic screen	Over metallic screen	Overall
	No.	mm ²	mm	mm	mm
MVNZ15AXUAPH001T016SAXXXX	3	16	14.7	19.0	40.0
MVNZ15AXUAPH001T025SAXXXX	3	25	16.0	20.0	43.0
MVNZ15AXUAPH001T035SAXXXX	3	35	17.0	21.0	45.0
MVNZ15AXUAPH001T050SAXXXX	3	50	18.1	22.0	47.0
MVNZ15AXUAPH001T070SAXXXX	3	70	19.7	24.0	51.0
MVNZ15AXUAPH001T095SAXXXX	3	95	21.3	25.0	54.0
MVNZ15AXUAPH001T120SAXXXX	3	120	22.9	27.0	58.0
MVNZ15AXUAPH001T150SAXXXX	3	150	24.2	28.0	60.0
MVNZ15AXUAPH001T185SAXXXX	3	185	25.9	30.0	64.0
MVNZ15AXUAPH001T240SAXXXX	3	240	28.4	33.0	70.0
MVNZ15AXUAPH001T300SAXXXX	3	300	31.0	35.0	76.0
MVNZ15AXUAPH001T400SAXXXX	3	400	34.1	39.0	83.0
MVNZ15AXUAPH001T500SAXXXX	3	500	37.9	43.0	92.0

- Above mentioned parameters are based on 3kA/sec earth fault current capacity of copper screen



POLYCAB TRIPLEX MV AS/NZS 1429.1 3.8/6.6 (7.2) KV
 MV Cable with Aluminium Conductor, XLPE Insulation, Copper Screen - Triplex

ELECTRICAL CHARACTERISTICS:

No. of Cores	Core Cross sectional Area	Max. DC Resistance at 20°C	Max. AC Resistance at 90°C	Approx. Capacitance	Approx. Inductance	Approx. Reactance	Continuous Current Rating		
							Buried direct in ground	In a buried duct	In Air
									
No.	mm ²	Ω/km	Ω/km	μF/km	mH/km	Ω/km	Amps		
3 x 1	16	1.91	2.449	0.22	0.478	0.150	78	67	84
3 x 1	25	1.2	1.539	0.25	0.442	0.139	100	87	110
3 x 1	35	0.868	1.113	0.28	0.421	0.132	119	103	132
3 x 1	50	0.641	0.822	0.31	0.401	0.126	140	122	158
3 x 1	70	0.443	0.568	0.36	0.370	0.116	171	150	196
3 x 1	95	0.32	0.411	0.4	0.353	0.111	203	179	236
3 x 1	120	0.253	0.325	0.45	0.336	0.106	232	205	273
3 x 1	150	0.206	0.265	0.49	0.326	0.103	260	231	309
3 x 1	185	0.164	0.211	0.53	0.317	0.100	294	262	355
3 x 1	240	0.125	0.161	0.58	0.306	0.096	340	305	415
3 x 1	300	0.1	0.130	0.6	0.298	0.094	384	346	475
3 x 1	400	0.0778	0.102	0.62	0.291	0.091	438	398	552
3 x 1	500	0.0605	0.080	0.66	0.284	0.089	505	460	646

: Current ratings are in accordance with IEC 60502-2: Current Ratings are based on IEC 60502-2 & IEC 60287, Max. Conductor Temperature at 90°C, Ambient temperature at 30°C in Air / at 20°C in Ground, Thermal resistivity of Soil 1.5 k.m/W & for earthenware ducts 1.2k.m/W and Depth of Laying 0.8m.

Current rating de-rating factors for other than 30°C ambient air temperature.

20	25	35	40	45	50	55	60
1.08	1.04	0.96	0.91	0.87	0.82	0.76	0.71

Current rating de-rating factors for other than 20°C ground temperature.

10	15	25	30	35	40	45	50
1.07	1.04	0.96	0.93	0.89	0.85	0.80	0.76

POLYCAB TRIPLEX MV AS/NZS 1429.1 3.8/6.6 (7.2) KV
 MV Cable with Aluminium Conductor, XLPE Insulation, Copper Screen - Triplex

No. of Cores	Core Cross sectional Area	Max. pulling tension on conductor	Charging Current per phase	Zero sequence impedance	Electric Stress at Conductor Screen	Short circuit rating of Phase conductor
No.	mm ²	kN	Amps/Km	Ohms/Km	kV/mm	kA, 1 sec
3 x 1	16	0.8	0.26	3.6	2.1	1.5
3 x 1	25	1.3	0.3	2.7	2.0	2.4
3 x 1	35	1.8	0.33	2.3	2.0	3.3
3 x 1	50	2.5	0.37	2.0	1.9	4.7
3 x 1	70	3.5	0.43	1.7	1.9	6.6
3 x 1	95	4.8	0.48	1.6	1.8	9.0
3 x 1	120	6.0	0.54	1.5	1.8	11.3
3 x 1	150	7.5	0.58	1.4	1.8	14.2
3 x 1	185	9.3	0.63	1.4	1.7	17.4
3 x 1	240	12.0	0.69	1.3	1.7	22.6
3 x 1	300	15.0	0.72	1.3	1.5	28.3
3 x 1	400	20.0	0.74	1.3	1.4	37.6
3 x 1	500	25.0	0.79	1.2	1.3	47.2



OUR CERTIFICATION
 ISO 9001 | ISO 14001 | ISO 45001



OUR CERTIFICATION
 ISO 9001 | ISO 14001 | ISO 45001



POLYCAB TRIPLEX ANTI-TERMITE MV AS/NZS 1429.1 3.8/6.6 (7.2) KV
MV Cable with Aluminium Conductor, XLPE Insulation, Copper Screen - Triplex

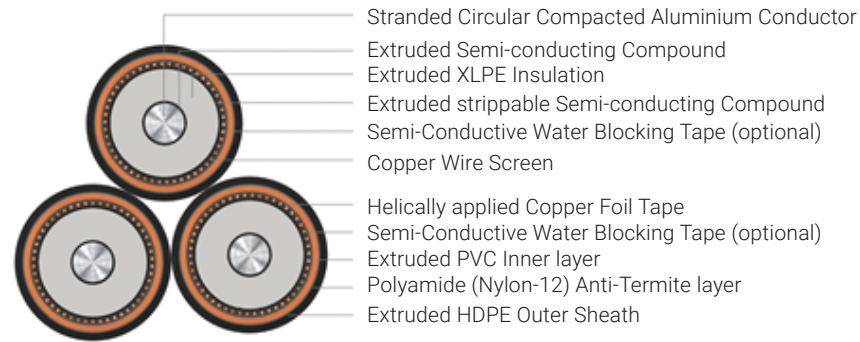

Salient Features

- Long life
- UV resistant
- Resistant to chemical exposure
- Resistant to water (AD7/AD8 with HDPE)
- Resistant to weather exposure
- Termite resistant

Application

POLYCAB MV 3.8/6.6 KV XLPE insulated with Aluminium conductor Triplex cable is suitable to use for power supply to wide networks i.e. Commercial, Industrial and Urban / Residential.

Voltage Rating

Nominal Voltage: 3.8/6.6 (7.2) kV

Operation Temperature

Min. installation temperature: 0°C
 Operating temperature: -25°C to +90°C
 Emergency operating temperature: 105°C
 (max. operation of 36hrs, at 3 periods for 12 consecutive months use)
 Max. Short Circuit Temperature: 250°C

Construction

- Conductor: Stranded Compacted Circular aluminium conductor as per AS/NZS 1125
- Conductor Screen: Extruded Semi-conductive compound
- Insulation: XLPE
- Insulation Screen: Extruded Strippable Semi-conductive compound
- Longitudinal Water blocking : Water blocking tape above and below copper screen (Optional)
- Metallic Insulation Screen: Copper Wire Screen + helically applied copper tape (E/F current capacity – Based on requirement)

Composite sheath

- Inner layer : Extruded Polyvinyl Chloride, Colour: Orange
 - Termite Protection: Polyamide (Nylon -12)
 - Outer layer: HDPE (Black)
- Three Single Core Cables twisted and assembled to form triplex formation

Bending Radius:

Fixed Installation: 20D
 During Installation: 30D

D is diameter over nylon

Standard and References:

AS/NZS 1429.1
 AS/NZS 1125
 AS/NZS 3808

High Voltage Test (kV AC)	Partial discharge test (kV AC)		Impulse test Voltage (kV peak)
	200% to rated voltage	150% to rated voltage	
12.5	7.6	5.7	60

Compliance

- Conductor resistance AS/NZS 1125
- Insulation resistance AS/NZS 1429.1
- Voltage test AS/NZS 1429.1



POLYCAB TRIPLEX MV AS/NZS 1429.1 3.8/6.6 (7.2) KV
MV Cable with Aluminium Conductor, XLPE Insulation, Copper Screen - Triplex

DIMENSIONAL CHARACTERISTICS:



Product Code	No. of Cores	Core Cross sectional Area	Nominal Diameter		
			Under metallic screen	Over metallic screen	Overall
	No.	mm ²	mm	mm	mm
MVNZ15AXUAPH001T016SAXXXX	3	16	14.7	21.0	45.0
MVNZ15AXUAPH001T025SAXXXX	3	25	16.0	22.0	47.0
MVNZ15AXUAPH001T035SAXXXX	3	35	17.0	23.0	49.0
MVNZ15AXUAPH001T050SAXXXX	3	50	18.1	24.0	52.0
MVNZ15AXUAPH001T070SAXXXX	3	70	19.7	26.0	55.0
MVNZ15AXUAPH001T095SAXXXX	3	95	21.3	27.0	59.0
MVNZ15AXUAPH001T120SAXXXX	3	120	22.9	29.0	62.0
MVNZ15AXUAPH001T150SAXXXX	3	150	24.2	30.0	65.0
MVNZ15AXUAPH001T185SAXXXX	3	185	25.9	32.0	69.0
MVNZ15AXUAPH001T240SAXXXX	3	240	28.4	35.0	74.0
MVNZ15AXUAPH001T300SAXXXX	3	300	31.0	37.0	80.0
MVNZ15AXUAPH001T400SAXXXX	3	400	34.1	40.0	86.0
MVNZ15AXUAPH001T500SAXXXX	3	500	37.9	44.0	95.0

- Above mentioned parameters are based on 3kA/sec earth fault current capacity of copper screen



POLYCAB TRIPLEX MV AS/NZS 1429.1 3.8/6.6 (7.2) KV
 MV Cable with Aluminium Conductor, XLPE Insulation, Copper Screen - Triplex

ELECTRICAL CHARACTERISTICS:

No. of Cores	Core Cross sectional Area	Max. DC Resistance at 20°C	Max. AC Resistance at 90°C	Approx. Capacitance	Approx. Inductance	Approx. Reactance	Continuous Current Rating		
							Buried direct in ground	In a buried duct	In Air
									
No.	mm ²	Ω/km	Ω/km	μF/km	mH/km	Ω/km	Amps		
3 x 1	16	1.91	2.45	0.22	0.500	0.157	78	67	84
3 x 1	25	1.2	1.54	0.25	0.463	0.145	100	87	110
3 x 1	35	0.868	1.11	0.28	0.441	0.138	119	103	132
3 x 1	50	0.641	0.82	0.31	0.421	0.132	140	122	158
3 x 1	70	0.443	0.57	0.36	0.388	0.122	171	150	196
3 x 1	95	0.32	0.41	0.4	0.370	0.116	203	179	236
3 x 1	120	0.253	0.32	0.45	0.352	0.111	232	205	273
3 x 1	150	0.206	0.26	0.49	0.342	0.107	260	231	309
3 x 1	185	0.164	0.21	0.53	0.330	0.104	294	262	355
3 x 1	240	0.125	0.16	0.58	0.318	0.100	340	305	415
3 x 1	300	0.1	0.13	0.6	0.308	0.097	384	346	475
3 x 1	400	0.0778	0.10	0.62	0.300	0.094	438	398	552
3 x 1	500	0.0605	0.08	0.66	0.290	0.091	505	460	646

: Current ratings are in accordance with IEC 60502-2: Current Ratings are based on IEC 60502-2 & IEC 60287, Max. Conductor Temperature at 90°C, Ambient temperature at 30°C in Air / at 20°C in Ground, Thermal resistivity of Soil 1.5 k.m/W & for earthenware ducts 1.2k.m/W and Depth of Laying 0.8m.

Current rating de-rating factors for other than 30°C ambient air temperature.

20	25	35	40	45	50	55	60
1.08	1.04	0.96	0.91	0.87	0.82	0.76	0.71

Current rating de-rating factors for other than 20°C ground temperature.

10	15	25	30	35	40	45	50
1.07	1.04	0.96	0.93	0.89	0.85	0.80	0.76

POLYCAB TRIPLEX MV AS/NZS 1429.1 3.8/6.6 (7.2) KV
 MV Cable with Aluminium Conductor, XLPE Insulation, Copper Screen - Triplex

No. of Cores	Core Cross sectional Area	Max. pulling tension on conductor	Charging Current per phase	Zero sequence impedance	Electric Stress at Conductor Screen	Short circuit rating of Phase conductor
No.	mm ²	kN	Amps/Km	Ohms/Km	kV/mm	kA, 1 sec
3 x 1	16	0.8	0.26	3.61	2.1	1.5
3 x 1	25	1.25	0.3	2.70	2.0	2.4
3 x 1	35	1.75	0.33	2.27	2.0	3.3
3 x 1	50	2.5	0.37	1.98	1.9	4.7
3 x 1	70	3.5	0.43	1.73	1.9	6.6
3 x 1	95	4.75	0.48	1.57	1.8	9.0
3 x 1	120	6	0.54	1.48	1.8	11.3
3 x 1	150	7.5	0.58	1.42	1.8	14.2
3 x 1	185	9.25	0.63	1.37	1.7	17.4
3 x 1	240	12	0.69	1.32	1.7	22.6
3 x 1	300	15	0.72	1.29	1.5	28.3
3 x 1	400	20	0.74	1.26	1.4	37.6
3 x 1	500	25	0.79	1.24	1.3	47.2



OUR CERTIFICATION
 ISO 9001 | ISO 14001 | ISO 45001



OUR CERTIFICATION
 ISO 9001 | ISO 14001 | ISO 45001



POLYCAB TRIPLEX MV AS/NZS 1429.1 6.35/11 (12) KV
MV Cable with Copper Conductor, XLPE Insulation, Copper Screen - Triplex

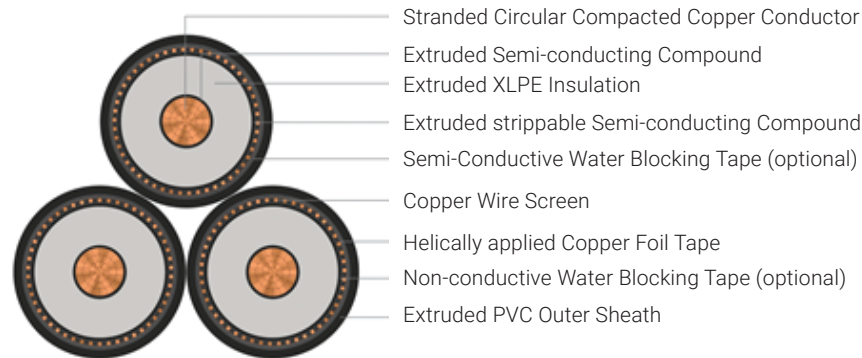

- Salient Features**
- Long life
 - UV resistant
 - Resistant to chemical exposure
 - Resistant to water (AD7/AD8 with HDPE)
 - Resistant to weather exposure
 - Termite resistant (Optional)

Application
POLYCAB MV 6.35/11 KV XLPE insulated with Copper conductor Triplex cable is suitable to use for power supply to wide networks i.e. Commercial, Industrial and Urban / Residential.

Voltage Rating
Nominal Voltage: 6.35/11 (12) kV

Operation Temperature
Min. installation temperature: 0°C
Operating temperature: -25°C to +90°C
Emergency operating temperature: 105°C
(max. operation of 36hrs, at 3 periods for 12 consecutive months use)
Max. Short Circuit Temperature: 250°C

Construction

- Conductor: Stranded Compacted Circular Copper conductor as per AS/NZS 1125
- Conductor Screen: Extruded Semi-conductive compound
- Insulation: XLPE
- Insulation Screen: Extruded Strippable Semi-conductive compound
- Longitudinal Water blocking : Water blocking tape above and below copper screen (Optional)
- Metallic Insulation Screen: Copper Wire Screen + helically applied copper tape (E/F current capacity – Based on requirement)
- Outer Sheath: Extruded Polyvinyl Chloride, Colour: Black
- Termite Protection: Polyamide (Nylon -12) (optional)
(Alternative Sheath: PVC+HDPE Composite Sheath or PVC + Nylon + HDPE (composite sheath with anti-termite properties) or LSZH Outer sheath, and parameters will change accordingly)

Three Single Core Cables twisted and assembled to form triplex formation

Bending Radius:
Fixed Installation: 12D (PVC) / 15D (HDPE) / 20D (Nylon)
During Installation: 18D (PVC) / 25D (HDPE) / 30D (Nylon)

D is overall diameter of each cable

Standard and References:
AS/NZS 1429.1
AS/NZS 1125
AS/NZS 3808

High Voltage Test (kV AC)	Partial discharge test (kV AC)		Impulse test Voltage (kV peak)
	200% to rated voltage	150% to rated voltage	
21	13	17	95

Compliance

- Conductor resistance AS/NZS 1125
- Insulation resistance AS/NZS 1429.1
- Short Circuit Temp. IEC 60986



POLYCAB TRIPLEX MV AS/NZS 1429.1 6.35/11 (12) KV
MV Cable with Copper Conductor, XLPE Insulation, Copper Screen - Triplex

DIMENSIONAL CHARACTERISTICS:



Product Code	No. of Cores	Core Cross sectional Area	Nominal Diameter		
			Under metallic screen	Over metallic screen	Overall
	No.	mm ²	mm	mm	mm
MVNZ17CXUAPH001T016SAXXXX	3	16	16.6	21.0	44.0
MVNZ17CXUAPH001T025SAXXXX	3	25	17.8	22.0	46.0
MVNZ17CXUAPH001T035SAXXXX	3	35	18.8	23.0	49.0
MVNZ17CXUAPH001T050SAXXXX	3	50	19.9	24.0	51.0
MVNZ17CXUAPH001T070SAXXXX	3	70	21.5	25.0	54.0
MVNZ17CXUAPH001T095SAXXXX	3	95	23.1	27.0	58.0
MVNZ17CXUAPH001T120SAXXXX	3	120	24.7	29.0	61.0
MVNZ17CXUAPH001T150SAXXXX	3	150	26.0	30.0	65.0
MVNZ17CXUAPH001T185SAXXXX	3	185	27.7	32.0	68.0
MVNZ17CXUAPH001T240SAXXXX	3	240	30.0	34.0	74.0
MVNZ17CXUAPH001T300SAXXXX	3	300	32.2	37.0	79.0
MVNZ17CXUAPH001T400SAXXXX	3	400	34.9	40.0	85.0
MVNZ17CXUAPH001T500SAXXXX	3	500	38.3	43.0	93.0

• Above mentioned parameters are based on 3kA/sec earth fault current capacity of copper screen



POLYCAB TRIPLEX MV AS/NZS 1429.1 6.35/11 (12) KV
 MV Cable with Copper Conductor, XLPE Insulation, Copper Screen - Triplex

ELECTRICAL CHARACTERISTICS:

No. of Cores	Core Cross sectional Area	Max. DC Resistance at 20°C	Max. AC Resistance at 90°C	Approx. Capacitance	Approx. Inductance	Approx. Reactance	Continuous Current Rating		
							Buried direct in ground	In a buried duct	In Air
									
No.	mm ²	Ω/km	Ω/km	μF/km	mH/km	Ω/km	Amps		
3 x 1	16	1.15	1.466	0.18	0.493	0.155	101	87	109
3 x 1	25	0.727	0.927	0.2	0.460	0.144	129	112	142
3 x 1	35	0.524	0.668	0.22	0.437	0.137	153	133	170
3 x 1	50	0.387	0.494	0.25	0.417	0.131	181	158	204
3 x 1	70	0.268	0.342	0.28	0.385	0.121	221	193	253
3 x 1	95	0.193	0.247	0.31	0.367	0.115	262	231	304
3 x 1	120	0.153	0.196	0.35	0.349	0.110	298	264	351
3 x 1	150	0.124	0.159	0.37	0.340	0.107	334	297	398
3 x 1	185	0.0991	0.128	0.41	0.329	0.103	377	336	455
3 x 1	240	0.0754	0.098	0.46	0.317	0.099	434	390	531
3 x 1	300	0.0601	0.079	0.5	0.306	0.096	489	441	606
3 x 1	400	0.047	0.063	0.56	0.296	0.093	553	501	696
3 x 1	500	0.0366	0.051	0.63	0.286	0.090	632	574	800

*: Current Ratings are based on IEC 60502-2 & IEC 60287, Max. Conductor Temperature at 90°C, Ambient temperature at 30°C in Air / at 20°C in Ground, Thermal resistivity of Soil 1.5 k.m/W & for earthenware ducts 1.2k.m/W and Depth of Laying 0.8m.

Current rating de-rating factors for other than 30°C ambient air temperature.

20	25	35	40	45	50	55	60
1.08	1.04	0.96	0.91	0.87	0.82	0.76	0.71

Current rating de-rating factors for other than 20°C ground temperature.

10	15	25	30	35	40	45	50
1.07	1.04	0.96	0.93	0.89	0.85	0.80	0.76

POLYCAB TRIPLEX MV AS/NZS 1429.1 6.35/11 (12) KV
 MV Cable with Copper Conductor, XLPE Insulation, Copper Screen - Triplex

No. of Cores	Core Cross sectional Area	Max. pulling tension on conductor	Charging Current per phase	Zero sequence impedance	Electric Stress at Conductor Screen	Short circuit rating of Phase conductor
No.	mm ²	kN	Amps/Km	Ohms/Km	kV/mm	kA, 1 sec
3 x 1	16	1.1	0.36	2.6	2.8	2.3
3 x 1	25	1.3	0.4	2.7	2.7	3.6
3 x 1	35	1.8	0.44	2.3	2.6	5.0
3 x 1	50	2.5	0.5	2.0	2.5	7.2
3 x 1	70	3.5	0.56	1.7	2.4	10.0
3 x 1	95	4.8	0.62	1.6	2.3	13.6
3 x 1	120	6.0	0.7	1.5	2.3	17.1
3 x 1	150	7.5	0.74	1.4	2.3	21.4
3 x 1	185	9.3	0.82	1.4	2.2	26.4
3 x 1	240	12.0	0.92	1.3	2.2	34.3
3 x 1	300	15.0	1	1.3	2.2	42.8
3 x 1	400	20.0	1.12	1.3	2.1	56.9
3 x 1	500	25.0	1.26	1.2	2.1	71.5



OUR CERTIFICATION
 ISO 9001 | ISO 14001 | ISO 45001



OUR CERTIFICATION
 ISO 9001 | ISO 14001 | ISO 45001



POLYCAB TRIPLEX MV AS/NZS 1429.1 6.35/11 (12) KV
MV Cable with Aluminium Conductor, XLPE Insulation, Copper Screen - Triplex

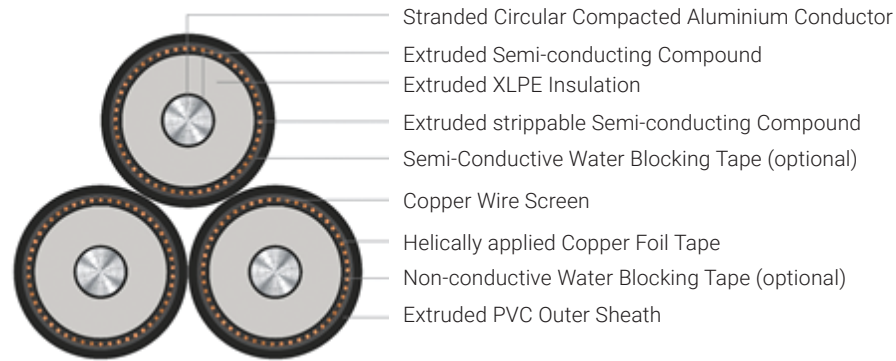

- Salient Features**
- Long life
 - UV resistant
 - Resistant to chemical exposure
 - Resistant to water (AD7/AD8 with HDPE)
 - Resistant to weather exposure

Application
POLYCAB MV 6.35/11 KV XLPE insulated with Aluminium conductor Triplex cable is suitable to use for power supply to wide networks i.e. Commercial, Industrial and Urban / Residential.

Voltage Rating
Nominal Voltage: 6.35/11 (12) kV

Operation Temperature
Min. installation temperature: 0°C
Operating temperature: -25°C to +90°C
Emergency operating temperature: 105°C
(max. operation of 36hrs, at 3 periods for 12 consecutive months use)
Max. Short Circuit Temperature: 250°C

Construction

- Conductor: Stranded Compacted Circular aluminium conductor as per AS/NZS 1125
- Conductor Screen: Extruded Semi-conductive compound
- Insulation: XLPE
- Insulation Screen: Extruded Strippable Semi-conductive compound
- Longitudinal Water blocking : Water blocking tape above and below copper screen (Optional)
- Metallic Insulation Screen: Copper Wire Screen + helically applied copper tape (E/F current capacity – Based on requirement)
- Outer Sheath: Extruded Polyvinyl Chloride, Colour: Black
- Termite Protection: Polyamide (Nylon -12) (optional)
(Alternative Sheath: PVC+HDPE Composite Sheath or LSZH Outer sheath, and parameters will change accordingly)

Three Single Core Cables twisted and assembled to form triplex formation

Bending Radius:
Fixed Installation: 12D (PVC) / 15D (HDPE)
During Installation: 18D (PVC) / 25D (HDPE)

D is overall diameter of each cable

Standard and References:
AS/NZS 1429.1
AS/NZS 1125
AS/NZS 3808

High Voltage Test (kV AC)	Partial discharge test (kV AC)		Impulse test Voltage (kV peak)
	200% to rated voltage	150% to rated voltage	
21	13	17	95

Compliance

- Conductor resistance AS/NZS 1125
- Insulation resistance AS/NZS 1429.1
- Voltage test AS/NZS 1429.1



POLYCAB TRIPLEX MV AS/NZS 1429.1 6.35/11 (12) KV
MV Cable with Aluminium Conductor, XLPE Insulation, Copper Screen - Triplex

DIMENSIONAL CHARACTERISTICS:



Product Code	No. of Cores	Core Cross sectional Area	Nominal Diameter		
			Under metallic screen	Over metallic screen	Overall
	No.	mm ²	mm	mm	mm
MVNZ17AXUAPH001T016SAXXXX	3	16	16.5	20.0	44.0
MVNZ17AXUAPH001T025SAXXXX	3	25	17.8	22.0	46.0
MVNZ17AXUAPH001T035SAXXXX	3	35	18.8	23.0	49.0
MVNZ17AXUAPH001T050SAXXXX	3	50	19.9	24.0	51.0
MVNZ17AXUAPH001T070SAXXXX	3	70	21.5	25.0	54.0
MVNZ17AXUAPH001T095SAXXXX	3	95	23.1	27.0	58.0
MVNZ17AXUAPH001T120SAXXXX	3	120	24.7	29.0	61.0
MVNZ17AXUAPH001T150SAXXXX	3	150	26.0	30.0	65.0
MVNZ17AXUAPH001T185SAXXXX	3	185	27.7	32.0	68.0
MVNZ17AXUAPH001T240SAXXXX	3	240	30.0	34.0	74.0
MVNZ17AXUAPH001T300SAXXXX	3	300	32.2	37.0	79.0
MVNZ17AXUAPH001T400SAXXXX	3	400	34.9	40.0	85.0
MVNZ17AXUAPH001T500SAXXXX	3	500	38.3	43.0	93.0

• Above mentioned parameters are based on 3kA/sec earth fault current capacity of copper screen



POLYCAB TRIPLEX MV AS/NZS 1429.1 6.35/11 (12) KV
MV Cable with Aluminium Conductor, XLPE Insulation, Copper Screen - Triplex

ELECTRICAL CHARACTERISTICS:

No. of Cores	Core Cross sectional Area	Max. DC Resistance at 20°C	Max. AC Resistance at 90°C	Approx. Capacitance	Approx. Inductance	Approx. Reactance	Continuous Current Rating		
							Buried direct in ground	In a buried duct	In Air
									
No.	mm ²	Ω/km	Ω/km	μF/km	mH/km	Ω/km	Amps		
3 x 1	16	1.91	2.449	0.17	0.497	0.156	78	67	84
3 x 1	25	1.2	1.539	0.2	0.460	0.144	100	87	110
3 x 1	35	0.868	1.113	0.22	0.437	0.137	119	103	132
3 x 1	50	0.641	0.822	0.25	0.417	0.131	140	122	158
3 x 1	70	0.443	0.568	0.28	0.385	0.121	171	150	196
3 x 1	95	0.32	0.411	0.31	0.367	0.115	203	179	236
3 x 1	120	0.253	0.325	0.35	0.349	0.110	232	205	273
3 x 1	150	0.206	0.265	0.37	0.340	0.107	260	231	309
3 x 1	185	0.164	0.211	0.41	0.329	0.103	294	262	355
3 x 1	240	0.125	0.161	0.46	0.317	0.099	340	305	415
3 x 1	300	0.1	0.130	0.5	0.306	0.096	384	346	475
3 x 1	400	0.0778	0.102	0.56	0.296	0.093	438	398	552
3 x 1	500	0.0605	0.080	0.63	0.286	0.090	505	460	646

*: Current Ratings are based on IEC 60502-2 & IEC 60287, Max. Conductor Temperature at 90°C, Ambient temperature at 30°C in Air / at 20°C in Ground, Thermal resistivity of Soil 1.5 k.m/W & for earthenware ducts 1.2k.m/W and Depth of Laying 0.8m.

Current rating de-rating factors for other than 30°C ambient air temperature.

20	25	35	40	45	50	55	60
1.08	1.04	0.96	0.91	0.87	0.82	0.76	0.71

Current rating de-rating factors for other than 20°C ground temperature.

10	15	25	30	35	40	45	50
1.07	1.04	0.96	0.93	0.89	0.85	0.80	0.76

POLYCAB TRIPLEX MV AS/NZS 1429.1 6.35/11 (12) KV
MV Cable with Aluminium Conductor, XLPE Insulation, Copper Screen - Triplex

No. of Cores	Core Cross sectional Area	Max. pulling tension on conductor	Charging Current per phase	Zero sequence impedance	Electric Stress at Conductor Screen	Short circuit rating of Phase conductor
No.	mm ²	kN	Amps/Km	Ohms/Km	kV/mm	kA, 1 sec
3 x 1	16	0.8	0.34	3.6	2.9	1.5
3 x 1	25	1.3	0.4	2.7	2.7	2.4
3 x 1	35	1.8	0.44	2.3	2.6	3.3
3 x 1	50	2.5	0.5	2.0	2.5	4.7
3 x 1	70	3.5	0.56	1.7	2.4	6.6
3 x 1	95	4.8	0.62	1.6	2.3	9.0
3 x 1	120	6.0	0.7	1.5	2.3	11.3
3 x 1	150	7.5	0.74	1.4	2.3	14.2
3 x 1	185	9.3	0.82	1.4	2.2	17.4
3 x 1	240	12.0	0.92	1.3	2.2	22.6
3 x 1	300	15.0	1	1.3	2.2	28.3
3 x 1	400	20.0	1.12	1.3	2.1	37.6
3 x 1	500	25.0	1.26	1.2	2.1	47.2



OUR CERTIFICATION
ISO 9001 | ISO 14001 | ISO 45001



OUR CERTIFICATION
ISO 9001 | ISO 14001 | ISO 45001



POLYCAB TRIPLEX ANTI-TERMITE MV AS/NZS 1429.1 6.35/11 (12) KV
MV Cable with Aluminium Conductor, XLPE Insulation, Copper Screen - Triplex

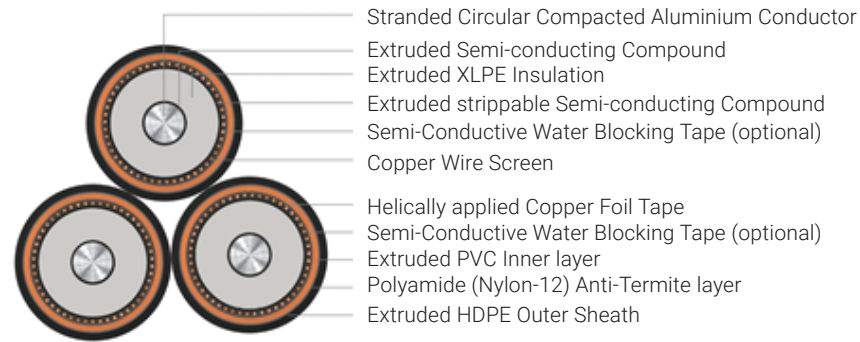

Salient Features

- Long life
- UV resistant
- Resistant to chemical exposure
- Resistant to water (AD7/AD8 with HDPE)
- Resistant to weather exposure
- Termite resistant

Application

POLYCAB MV 6.35/11 KV XLPE insulated with Aluminium conductor Triplex cable is suitable to use for power supply to wide networks i.e. Commercial, Industrial and Urban / Residential.

Voltage Rating

Nominal Voltage: 6.35/11 (12) KV

Operation Temperature

Min. installation temperature: 0°C
 Operating temperature: -25°C to +90°C
 Emergency operating temperature: 105°C
 (max. operation of 36hrs, at 3 periods for 12 consecutive months use)
 Max. Short Circuit Temperature: 250°C

Construction

- Conductor: Stranded Compacted Circular aluminium conductor as per AS/NZS 1125
- Conductor Screen: Extruded Semi-conductive compound
- Insulation: XLPE
- Insulation Screen: Extruded Strippable Semi-conductive compound
- Longitudinal Water blocking : Water blocking tape above and below copper screen (Optional)
- Metallic Insulation Screen: Copper Wire Screen + helically applied copper tape (E/F current capacity – Based on requirement)

Composite sheath

- Inner layer : Extruded Polyvinyl Chloride, Colour: Orange
 - Termite Protection: Polyamide (Nylon -12)
 - Outer layer: HDPE (Black)
- Three Single Core Cables twisted and assembled to form triplex formation

Bending Radius:

Fixed Installation: 20D
 During Installation: 30D

D is diameter over nylon

Standard and References:

AS/NZS 1429.1
 AS/NZS 1125
 AS/NZS 3808

High Voltage Test (kV AC)	Partial discharge test (kV AC)		Impulse test Voltage (kV peak)
	200% to rated voltage	150% to rated voltage	
21	13	17	95

Compliance

- Conductor resistance AS/NZS 1125
- Insulation resistance AS/NZS 1429.1
- Voltage test AS/NZS 1429.1



POLYCAB TRIPLEX ANTI-TERMITE MV AS/NZS 1429.1 6.35/11 (12) KV
MV Cable with Aluminium Conductor, XLPE Insulation, Copper Screen - Triplex

DIMENSIONAL CHARACTERISTICS:



Product Code	No. of Cores	Core Cross sectional Area	Nominal Diameter		
			Under metallic screen	Over metallic screen	Overall
	No.	mm ²	mm	mm	mm
MVNZ17AXUAPH001T016SAXXXX	3	16	16.5	20.0	44.0
MVNZ17AXUAPH001T025SAXXXX	3	25	17.8	22.0	46.0
MVNZ17AXUAPH001T035SAXXXX	3	35	18.8	23.0	49.0
MVNZ17AXUAPH001T050SAXXXX	3	50	19.9	24.0	51.0
MVNZ17AXUAPH001T070SAXXXX	3	70	21.5	25.0	54.0
MVNZ17AXUAPH001T095SAXXXX	3	95	23.1	27.0	58.0
MVNZ17AXUAPH001T120SAXXXX	3	120	24.7	29.0	61.0
MVNZ17AXUAPH001T150SAXXXX	3	150	26.0	30.0	65.0
MVNZ17AXUAPH001T185SAXXXX	3	185	27.7	32.0	68.0
MVNZ17AXUAPH001T240SAXXXX	3	240	30.0	34.0	74.0
MVNZ17AXUAPH001T300SAXXXX	3	300	32.2	37.0	79.0
MVNZ17AXUAPH001T400SAXXXX	3	400	34.9	40.0	85.0
MVNZ17AXUAPH001T500SAXXXX	3	500	38.3	43.0	93.0

- Above mentioned parameters are based on 3kA/sec earth fault current capacity of copper screen

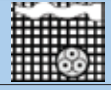

POLYCAB TRIPLEX ANTI-TERMITE MV AS/NZS 1429.1 6.35/11 (12) KV
MV Cable with Aluminium Conductor, XLPE Insulation, Copper Screen - Triplex

ELECTRICAL CHARACTERISTICS:

No. of Cores	Core Cross sectional Area	Max. DC Resistance at 20°C	Max. AC Resistance at 90°C	Approx. Capacitance	Approx. Inductance	Approx. Reactance	Continuous Current Rating		
							Buried direct in ground	In a buried duct	In Air
									
No.	mm ²	Ω/km	Ω/km	μF/km	mH/km	Ω/km	Amps		
3 x 1	16	1.91	2.449	0.17	0.497	0.156	78	67	84
3 x 1	25	1.2	1.539	0.2	0.460	0.144	100	87	110
3 x 1	35	0.868	1.113	0.22	0.437	0.137	119	103	132
3 x 1	50	0.641	0.822	0.25	0.417	0.131	140	122	158
3 x 1	70	0.443	0.568	0.28	0.385	0.121	171	150	196
3 x 1	95	0.32	0.411	0.31	0.367	0.115	203	179	236
3 x 1	120	0.253	0.325	0.35	0.349	0.110	232	205	273
3 x 1	150	0.206	0.265	0.37	0.340	0.107	260	231	309
3 x 1	185	0.164	0.211	0.41	0.329	0.103	294	262	355
3 x 1	240	0.125	0.161	0.46	0.317	0.099	340	305	415
3 x 1	300	0.1	0.130	0.5	0.306	0.096	384	346	475
3 x 1	400	0.0778	0.102	0.56	0.296	0.093	438	398	552
3 x 1	500	0.0605	0.080	0.63	0.286	0.090	505	460	646

*: Current Ratings are based on IEC 60502-2 & IEC 60287, Max. Conductor Temperature at 90°C, Ambient temperature at 30°C in Air / at 20°C in Ground, Thermal resistivity of Soil 1.5 k.m/W & for earthenware ducts 1.2k.m/W and Depth of Laying 0.8m.

Current rating de-rating factors for other than 30°C ambient air temperature.

20	25	35	40	45	50	55	60
1.08	1.04	0.96	0.91	0.87	0.82	0.76	0.71

Current rating de-rating factors for other than 20°C ground temperature.

10	15	25	30	35	40	45	50
1.07	1.04	0.96	0.93	0.89	0.85	0.80	0.76

POLYCAB TRIPLEX ANTI-TERMITE MV AS/NZS 1429.1 6.35/11 (12) KV
MV Cable with Aluminium Conductor, XLPE Insulation, Copper Screen - Triplex

No. of Cores	Core Cross sectional Area	Max. pulling tension on conductor	Charging Current per phase	Zero sequence impedance	Electric Stress at Conductor Screen	Short circuit rating of Phase conductor
No.	mm ²	kN	Amps/Km	Ohms/Km	kV/mm	kA, 1 sec
3 x 1	16	0.8	0.34	3.6	2.9	1.5
3 x 1	25	1.3	0.4	2.7	2.7	2.4
3 x 1	35	1.8	0.44	2.3	2.6	3.3
3 x 1	50	2.5	0.5	2.0	2.5	4.7
3 x 1	70	3.5	0.56	1.7	2.4	6.6
3 x 1	95	4.8	0.62	1.6	2.3	9.0
3 x 1	120	6.0	0.7	1.5	2.3	11.3
3 x 1	150	7.5	0.74	1.4	2.3	14.2
3 x 1	185	9.3	0.82	1.4	2.2	17.4
3 x 1	240	12.0	0.92	1.3	2.2	22.6
3 x 1	300	15.0	1	1.3	2.2	28.3
3 x 1	400	20.0	1.12	1.3	2.1	37.6
3 x 1	500	25.0	1.26	1.2	2.1	47.2



OUR CERTIFICATION
 ISO 9001 | ISO 14001 | ISO 45001



OUR CERTIFICATION
 ISO 9001 | ISO 14001 | ISO 45001



POLYCAB TRIPLEX MV AS/NZS 1429.1 12.7/22 (24) KV
MV Cable with Copper Conductor, XLPE Insulation, Copper Screen - Triplex

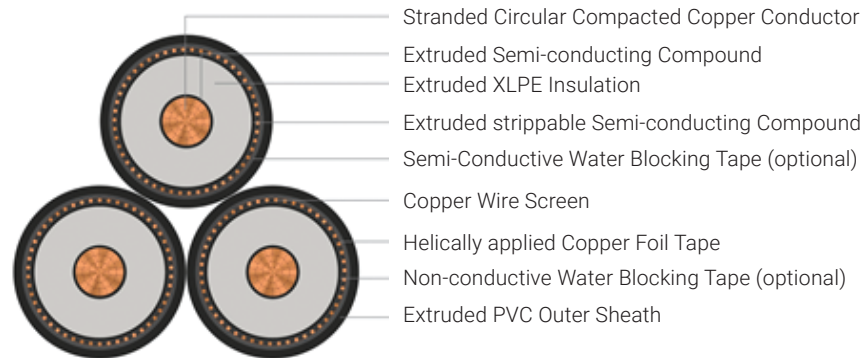

- Salient Features**
- Long life
 - UV resistant
 - Resistant to chemical exposure
 - Resistant to water (AD7/AD8 with HDPE)
 - Resistant to weather exposure
 - Termite resistant (Optional)

Application
POLYCAB MV 12.7/22 KV XLPE insulated with Copper conductor Triplex cable is suitable to use for power supply to wide networks i.e. Commercial, Industrial and Urban / Residential.

Voltage Rating
Nominal Voltage: 12.7/22 (24) kV

Operation Temperature
Min. installation temperature: 0°C
Operating temperature: -25°C to +90°C
Emergency operating temperature: 105°C
(max. operation of 36hrs, at 3 periods for 12 consecutive months use)
Max. Short Circuit Temperature: 250°C

Construction

- Conductor: Stranded Compacted Circular Copper conductor as per AS/NZS 1125
- Conductor Screen: Extruded Semi-conductive compound
- Insulation: XLPE
- Insulation Screen: Extruded Strippable Semi-conductive compound
- Longitudinal Water blocking : Water blocking tape above and below copper screen (Optional)
- Metallic Insulation Screen: Copper Wire Screen + helically applied copper tape (E/F current capacity – Based on requirement)
- Outer Sheath: Extruded Polyvinyl Chloride, Colour: Black
- Termite Protection: Polyamide (Nylon -12) (optional)
(Alternative Sheath: PVC+HDPE Composite Sheath or PVC + Nylon + HDPE (composite sheath with anti-termite properties) or LSZH Outer sheath, and parameters will change accordingly)

Three Single Core Cables twisted and assembled to form triplex formation

Bending Radius:
Fixed Installation: 12D (PVC) / 15D (HDPE) / 20D (Nylon)
During Installation: 18D (PVC) / 25D (HDPE) / 30D (Nylon)

D is overall diameter of each cable

Standard and References:
AS/NZS 1429.1
AS/NZS 1125
AS/NZS 3808

High Voltage Test (kV AC)	Partial discharge test (kV AC)		Impulse test Voltage (kV peak)
	200% to rated voltage	150% to rated voltage	
42	25	19	150

Compliance

- Conductor resistance AS/NZS 1125
- Insulation resistance AS/NZS 1429.1
- Short Circuit Temp. IEC 60986



POLYCAB TRIPLEX MV AS/NZS 1429.1 12.7/22 (24) KV
MV Cable with Copper Conductor, XLPE Insulation, Copper Screen - Triplex

DIMENSIONAL CHARACTERISTICS:



Product Code	No. of Cores	Core Cross sectional Area	Nominal Diameter		
			Under metallic screen	Over metallic screen	Overall
	No.	mm ²	mm	mm	mm
MVNZ12CXUAPH001T035SAXXXX	3	35	23.0	27.0	58.0
MVNZ12CXUAPH001T050SAXXXX	3	50	24.1	28.0	60.0
MVNZ12CXUAPH001T070SAXXXX	3	70	25.8	30.0	64.0
MVNZ12CXUAPH001T095SAXXXX	3	95	27.3	31.0	67.0
MVNZ12CXUAPH001T120SAXXXX	3	120	28.9	33.0	71.0
MVNZ12CXUAPH001T150SAXXXX	3	150	30.3	35.0	74.0
MVNZ12CXUAPH001T185SAXXXX	3	185	32.0	37.0	78.0
MVNZ12CXUAPH001T240SAXXXX	3	240	34.3	39.0	83.0
MVNZ12CXUAPH001T300SAXXXX	3	300	36.3	41.0	88.0
MVNZ12CXUAPH001T400SAXXXX	3	400	39.1	44.0	94.0
MVNZ12CXUAPH001T500SAXXXX	3	500	42.5	48.0	102.0

• Above mentioned parameters are based on 3kA/sec earth fault current capacity of copper screen



POLYCAB TRIPLEX MV AS/NZS 1429.1 12.7/22 (24) KV
 MV Cable with Copper Conductor, XLPE Insulation, Copper Screen - Triplex

ELECTRICAL CHARACTERISTICS:

No. of Cores	Core Cross sectional Area	Max. DC Resistance at 20°C	Max. AC Resistance at 90°C	Approx. Capacitance	Approx. Inductance	Approx. Reactance	Continuous Current Rating		
							Buried direct in ground	In a buried duct	In Air
									
No.	mm ²	Ω/km	Ω/km	μF/km	mH/km	Ω/km	Amps		
3 x 1	35	0.524	0.668	0.16	0.472	0.148	153	133	170
3 x 1	50	0.387	0.494	0.17	0.450	0.142	181	158	204
3 x 1	70	0.268	0.342	0.2	0.416	0.131	221	193	253
3 x 1	95	0.193	0.247	0.22	0.397	0.125	262	231	304
3 x 1	120	0.153	0.196	0.24	0.379	0.119	298	264	351
3 x 1	150	0.124	0.159	0.26	0.367	0.115	334	297	398
3 x 1	185	0.0991	0.128	0.28	0.355	0.112	377	336	455
3 x 1	240	0.0754	0.098	0.31	0.340	0.107	434	390	531
3 x 1	300	0.0601	0.079	0.33	0.329	0.103	489	441	606
3 x 1	400	0.047	0.063	0.37	0.318	0.100	553	501	696
3 x 1	500	0.0366	0.051	0.41	0.306	0.096	632	574	800

*: Current Ratings are based on IEC 60502-2 & IEC 60287, Max. Conductor Temperature at 90°C, Ambient temperature at 30°C in Air / at 20°C in Ground, Thermal resistivity of Soil 1.5 k.m/W & for earthenware ducts 1.2k.m/W and Depth of Laying 0.8m.

Current rating de-rating factors for other than 30°C ambient air temperature.

20	25	35	40	45	50	55	60
1.08	1.04	0.96	0.91	0.87	0.82	0.76	0.71

Current rating de-rating factors for other than 20°C ground temperature.

10	15	25	30	35	40	45	50
1.07	1.04	0.96	0.93	0.89	0.85	0.80	0.76

POLYCAB TRIPLEX MV AS/NZS 1429.1 12.7/22 (24) KV
 MV Cable with Copper Conductor, XLPE Insulation, Copper Screen - Triplex

No. of Cores	Core Cross sectional Area	Max. pulling tension on conductor	Charging Current per phase	Zero sequence impedance	Electric Stress at Conductor Screen	Short circuit rating of Phase conductor
No.	mm ²	kN	Amps/Km	Ohms/Km	kV/mm	kA, 1 sec
3 x 1	35	2.5	0.64	1.8	3.7	5.0
3 x 1	50	3.5	0.68	1.7	3.5	7.2
3 x 1	70	4.9	0.8	1.5	3.4	10.0
3 x 1	95	6.7	0.88	1.4	3.2	13.6
3 x 1	120	8.4	0.96	1.4	3.1	17.1
3 x 1	150	10.5	1.04	1.3	3.1	21.4
3 x 1	185	13.0	1.12	1.3	3.0	26.4
3 x 1	240	16.8	1.24	1.3	2.9	34.3
3 x 1	300	21.0	1.32	1.2	2.9	42.8
3 x 1	400	28.0	1.48	1.2	2.8	56.9
3 x 1	500	35.0	1.64	1.2	2.7	71.5



OUR CERTIFICATION
 ISO 9001 | ISO 14001 | ISO 45001



OUR CERTIFICATION
 ISO 9001 | ISO 14001 | ISO 45001



POLYCAB TRIPLEX MV AS/NZS 1429.1 12.7/22 (24) KV
MV Cable with Aluminium Conductor, XLPE Insulation, Copper Screen - Triplex

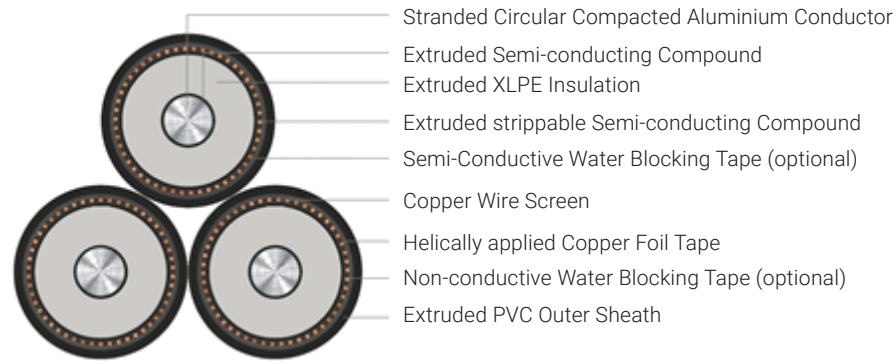

- Salient Features**
- Long life
 - UV resistant
 - Resistant to chemical exposure
 - Resistant to water (AD7/AD8 with HDPE)
 - Resistant to weather exposure

Application
POLYCAB MV 12.7/22 KV XLPE insulated with Aluminium conductor Triplex cable is suitable to use for power supply to wide networks i.e. Commercial, Industrial and Urban / Residential.

Voltage Rating
Nominal Voltage: 12.7/22 (24) kV

Operation Temperature
Min. installation temperature: 0°C
Operating temperature: -25°C to +90°C
Emergency operating temperature: 105°C
(max. operation of 36hrs, at 3 periods for 12 consecutive months use)
Max. Short Circuit Temperature: 250°C

Construction

- Conductor: Stranded Compacted Circular aluminium conductor as per AS/NZS 1125
- Conductor Screen: Extruded Semi-conductive compound
- Insulation: XLPE
- Insulation Screen: Extruded Strippable Semi-conductive compound
- Longitudinal Water blocking : Water blocking tape above and below copper screen (Optional)
- Metallic Insulation Screen: Copper Wire Screen + helically applied copper tape (E/F current capacity – Based on requirement)
- Outer Sheath: Extruded Polyvinyl Chloride, Colour: Black
- Termite Protection: Polyamide (Nylon -12) (optional)
(Alternative Sheath: PVC+HDPE Composite Sheath or LSZH Outer sheath, and parameters will change accordingly)

Three Single Core Cables twisted and assembled to form triplex formation

Bending Radius:
Fixed Installation: 12D (PVC) / 15D (HDPE)
During Installation: 18D (PVC) / 25D (HDPE)

D is overall diameter of each cable

Standard and References:
AS/NZS 1429.1
AS/NZS 1125
AS/NZS 3808

High Voltage Test (kV AC)	Partial discharge test (kV AC)		Impulse test Voltage (kV peak)
	200% to rated voltage	150% to rated voltage	
42	25	19	150

Compliance

- Conductor resistance AS/NZS 1125
- Insulation resistance AS/NZS 1429.1
- Voltage test AS/NZS 1429.1



POLYCAB TRIPLEX MV AS/NZS 1429.1 12.7/22 (24) KV
MV Cable with Aluminium Conductor, XLPE Insulation, Copper Screen - Triplex

DIMENSIONAL CHARACTERISTICS:



Product Code	No. of Cores	Core Cross sectional Area	Nominal Diameter		
			Under metallic screen	Over metallic screen	Overall
	No.	mm ²	mm	mm	mm
MVNZ12AXUAPH001T035SAXXXX	3	35	23.0	27.0	58.0
MVNZ12AXUAPH001T050SAXXXX	3	50	24.1	28.0	60.0
MVNZ12AXUAPH001T070SAXXXX	3	70	25.7	30.0	64.0
MVNZ12AXUAPH001T095SAXXXX	3	95	27.3	31.0	67.0
MVNZ12AXUAPH001T120SAXXXX	3	120	28.9	33.0	71.0
MVNZ12AXUAPH001T150SAXXXX	3	150	30.2	35.0	74.0
MVNZ12AXUAPH001T185SAXXXX	3	185	31.9	36.0	78.0
MVNZ12AXUAPH001T240SAXXXX	3	240	34.2	39.0	83.0
MVNZ12AXUAPH001T300SAXXXX	3	300	36.4	41.0	88.0
MVNZ12AXUAPH001T400SAXXXX	3	400	39.1	44.0	94.0
MVNZ12AXUAPH001T500SAXXXX	3	500	42.5	48.0	102.0

• Above mentioned parameters are based on 3kA/sec earth fault current capacity of copper screen



POLYCAB TRIPLEX MV AS/NZS 1429.1 12.7/22 (24) KV
 MV Cable with Aluminium Conductor, XLPE Insulation, Copper Screen - Triplex

ELECTRICAL CHARACTERISTICS:

No. of Cores	Core Cross sectional Area	Max. DC Resistance at 20°C	Max. AC Resistance at 90°C	Approx. Capacitance	Approx. Inductance	Approx. Reactance	Continuous Current Rating		
							Buried direct in ground	In a buried duct	In Air
									
No.	mm ²	Ω/km	Ω/km	μF/km	mH/km	Ω/km	Amps		
3 x 1	35	0.868	1.113	0.16	0.472	0.148	119	103	132
3 x 1	50	0.641	0.822	0.17	0.450	0.142	140	122	158
3 x 1	70	0.443	0.568	0.2	0.418	0.131	171	150	196
3 x 1	95	0.32	0.411	0.22	0.397	0.125	203	179	236
3 x 1	120	0.253	0.325	0.24	0.379	0.119	232	205	273
3 x 1	150	0.206	0.265	0.25	0.368	0.116	260	231	309
3 x 1	185	0.164	0.211	0.28	0.356	0.112	294	262	355
3 x 1	240	0.125	0.161	0.31	0.341	0.107	340	305	415
3 x 1	300	0.1	0.130	0.33	0.329	0.103	384	346	475
3 x 1	400	0.0778	0.102	0.37	0.318	0.100	438	398	552
3 x 1	500	0.0605	0.080	0.41	0.306	0.096	505	460	646

*: Current Ratings are based on IEC 60502-2 & IEC 60287, Max. Conductor Temperature at 90°C, Ambient temperature at 30°C in Air / at 20°C in Ground, Thermal resistivity of Soil 1.5 k.m/W & for earthenware ducts 1.2k.m/W and Depth of Laying 0.8m.

Current rating de-rating factors for other than 30°C ambient air temperature.

20	25	35	40	45	50	55	60
1.08	1.04	0.96	0.91	0.87	0.82	0.76	0.71

Current rating de-rating factors for other than 20°C ground temperature.

10	15	25	30	35	40	45	50
1.07	1.04	0.96	0.93	0.89	0.85	0.80	0.76

POLYCAB TRIPLEX MV AS/NZS 1429.1 12.7/22 (24) KV
 MV Cable with Aluminium Conductor, XLPE Insulation, Copper Screen - Triplex

No. of Cores	Core Cross sectional Area	Max. pulling tension on conductor	Charging Current per phase	Zero sequence impedance	Electric Stress at Conductor Screen	Short circuit rating of Phase conductor
No.	mm ²	kN	Amps/Km	Ohms/Km	kV/mm	kA, 1 sec
3 x 1	35	1.8	0.64	2.3	3.7	3.3
3 x 1	50	2.5	0.68	2.0	3.5	4.7
3 x 1	70	3.5	0.8	1.7	3.4	6.6
3 x 1	95	4.8	0.88	1.6	3.2	9.0
3 x 1	120	6.0	0.96	1.5	3.1	11.3
3 x 1	150	7.5	1	1.4	3.1	14.2
3 x 1	185	9.3	1.12	1.4	3.0	17.4
3 x 1	240	12.0	1.24	1.3	2.9	22.6
3 x 1	300	15.0	1.32	1.3	2.9	28.3
3 x 1	400	20.0	1.48	1.3	2.8	37.6
3 x 1	500	25.0	1.64	1.2	2.7	47.2



OUR CERTIFICATION
 ISO 9001 | ISO 14001 | ISO 45001



OUR CERTIFICATION
 ISO 9001 | ISO 14001 | ISO 45001



POLYCAB TRIPLEX ANTI-TERMITE MV AS/NZS 1429.1 12.7/22 (24) KV
MV Cable with Aluminium Conductor, XLPE Insulation, Copper Screen - Triplex

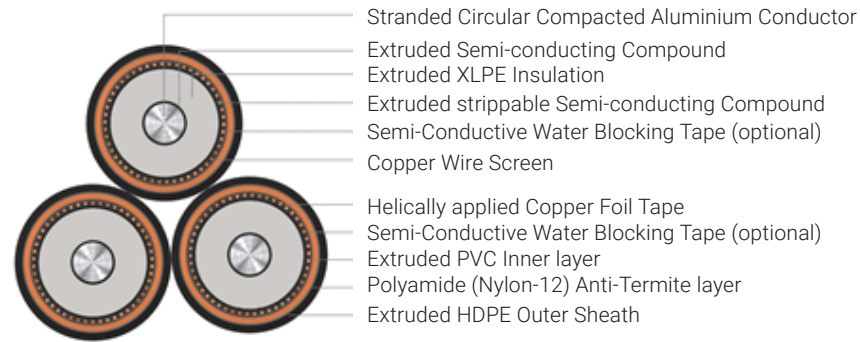

Salient Features

- Long life
- UV resistant
- Resistant to chemical exposure
- Resistant to water (AD7/AD8 with HDPE)
- Resistant to weather exposure
- Termite resistant

Application

POLYCAB MV 12.7/22 KV XLPE insulated with Aluminium conductor Triplex cable is suitable to use for power supply to wide networks i.e. Commercial, Industrial and Urban / Residential.

Voltage Rating

Nominal Voltage: 12.7/22 (24) kV

Operation Temperature

Min. installation temperature: 0°C
 Operating temperature: -25°C to +90°C
 Emergency operating temperature: 105°C
 (max. operation of 36hrs, at 3 periods for 12 consecutive months use)
 Max. Short Circuit Temperature: 250°C

Construction

- Conductor: Stranded Compacted Circular aluminium conductor as per AS/NZS 1125
- Conductor Screen: Extruded Semi-conductive compound
- Insulation: XLPE
- Insulation Screen: Extruded Strippable Semi-conductive compound
- Longitudinal Water blocking : Water blocking tape above and below copper screen (Optional)
- Metallic Insulation Screen: Copper Wire Screen + helically applied copper tape (E/F current capacity – Based on requirement)

Composite sheath

- Inner layer : Extruded Polyvinyl Chloride, Colour: Orange
 - Termite Protection: Polyamide (Nylon -12)
 - Outer layer: HDPE (Black)
- Three Single Core Cables twisted and assembled to form triplex formation

Bending Radius:

Fixed Installation: 20D
 During Installation: 30D

D is diameter over nylon

Standard and References:

AS/NZS 1429.1
 AS/NZS 1125
 AS/NZS 3808

High Voltage Test (kV AC)	Partial discharge test (kV AC)		Impulse test Voltage (kV peak)
	200% to rated voltage	150% to rated voltage	
42	25	19	150

Compliance

- Conductor resistance AS/NZS 1125
- Insulation resistance AS/NZS 1429.1
- Voltage test AS/NZS 1429.1



POLYCAB TRIPLEX ANTI-TERMITE MV AS/NZS 1429.1 12.7/22 (24) KV
MV Cable with Aluminium Conductor, XLPE Insulation, Copper Screen - Triplex

DIMENSIONAL CHARACTERISTICS:

Product Code	No. of Cores	Core Cross sectional Area	Nominal Diameter		
			Under metallic screen	Over metallic screen	Overall
	No.	mm ²	mm	mm	mm
MVNZ12AXUAPH001T035SAXXXX	3	35	23.0	29.0	62.0
MVNZ12AXUAPH001T050SAXXXX	3	50	24.1	30.0	65.0
MVNZ12AXUAPH001T070SAXXXX	3	70	25.7	32.0	68.0
MVNZ12AXUAPH001T095SAXXXX	3	95	27.3	33.0	72.0
MVNZ12AXUAPH001T120SAXXXX	3	120	28.9	35.0	75.0
MVNZ12AXUAPH001T150SAXXXX	3	150	30.2	36.0	78.0
MVNZ12AXUAPH001T185SAXXXX	3	185	31.9	38.0	82.0
MVNZ12AXUAPH001T240SAXXXX	3	240	34.2	40.0	87.0
MVNZ12AXUAPH001T300SAXXXX	3	300	36.4	43.0	91.0
MVNZ12AXUAPH001T400SAXXXX	3	400	39.1	45.0	97.0
MVNZ12AXUAPH001T500SAXXXX	3	500	42.5	49.0	105.0

- Above mentioned parameters are based on 3kA/sec earth fault current capacity of copper screen



OUR CERTIFICATION
 ISO 9001 | ISO 14001 | ISO 45001





OUR CERTIFICATION
 ISO 9001 | ISO 14001 | ISO 45001



POLYCAB TRIPLEX ANTI-TERMITE MV AS/NZS 1429.1 12.7/22 (24) KV
MV Cable with Aluminium Conductor, XLPE Insulation, Copper Screen - Triplex

ELECTRICAL CHARACTERISTICS:

No. of Cores	Core Cross sectional Area	Max. DC Resistance at 20°C	Max. AC Resistance at 90°C	Approx. Capacitance	Approx. Inductance	Approx. Reactance	Continuous Current Rating		
							Buried direct in ground	In a buried duct	In Air
									
No.	mm ²	Ω/km	Ω/km	μF/km	mH/km	Ω/km	Amps		
3 x 1	35	0.868	1.11	0.16	0.488	0.153	119	103	132
3 x 1	50	0.641	0.82	0.17	0.466	0.146	140	122	158
3 x 1	70	0.443	0.57	0.2	0.432	0.136	171	150	196
3 x 1	95	0.32	0.41	0.22	0.411	0.129	203	179	236
3 x 1	120	0.253	0.32	0.24	0.392	0.123	232	205	273
3 x 1	150	0.206	0.26	0.25	0.380	0.119	260	231	309
3 x 1	185	0.164	0.21	0.28	0.367	0.115	294	262	355
3 x 1	240	0.125	0.16	0.31	0.350	0.110	340	305	415
3 x 1	300	0.1	0.13	0.33	0.337	0.106	384	346	475
3 x 1	400	0.0778	0.10	0.37	0.324	0.102	438	398	552
3 x 1	500	0.0605	0.08	0.41	0.311	0.098	505	460	646

*: Current Ratings are based on IEC 60502-2 & IEC 60287, Max. Conductor Temperature at 90°C, Ambient temperature at 30°C in Air / at 20°C in Ground, Thermal resistivity of Soil 1.5 k.m/W & for earthenware ducts 1.2k.m/W and Depth of Laying 0.8m.

Current rating de-rating factors for other than 30°C ambient air temperature.

20	25	35	40	45	50	55	60
1.08	1.04	0.96	0.91	0.87	0.82	0.76	0.71

Current rating de-rating factors for other than 20°C ground temperature.

10	15	25	30	35	40	45	50
1.07	1.04	0.96	0.93	0.89	0.85	0.80	0.76

POLYCAB TRIPLEX ANTI-TERMITE MV AS/NZS 1429.1 12.7/22 (24) KV
MV Cable with Aluminium Conductor, XLPE Insulation, Copper Screen - Triplex

No. of Cores	Core Cross sectional Area	Max. pulling tension on conductor	Charging Current per phase	Zero sequence impedance	Electric Stress at Conductor Screen	Short circuit rating of Phase conductor
No.	mm ²	kN	Amps/Km	Ohms/Km	kV/mm	kA, 1 sec
3 x 1	35	1.75	0.64	2.27	3.7	3.3
3 x 1	50	2.5	0.68	1.98	3.5	4.7
3 x 1	70	3.5	0.8	1.73	3.4	6.6
3 x 1	95	4.75	0.88	1.57	3.2	9.0
3 x 1	120	6	0.96	1.49	3.1	11.3
3 x 1	150	7.5	1	1.43	3.1	14.2
3 x 1	185	9.25	1.12	1.37	3.0	17.4
3 x 1	240	12	1.24	1.32	2.9	22.6
3 x 1	300	15	1.32	1.29	2.9	28.3
3 x 1	400	20	1.48	1.26	2.8	37.6
3 x 1	500	25	1.64	1.24	2.7	47.2



OUR CERTIFICATION
 ISO 9001 | ISO 14001 | ISO 45001



OUR CERTIFICATION
 ISO 9001 | ISO 14001 | ISO 45001



POLYCAB TRIPLEX MV AS/NZS 1429.1 19/33 (36) KV
MV Cable with Copper Conductor, XLPE Insulation, Copper Screen - Triplex

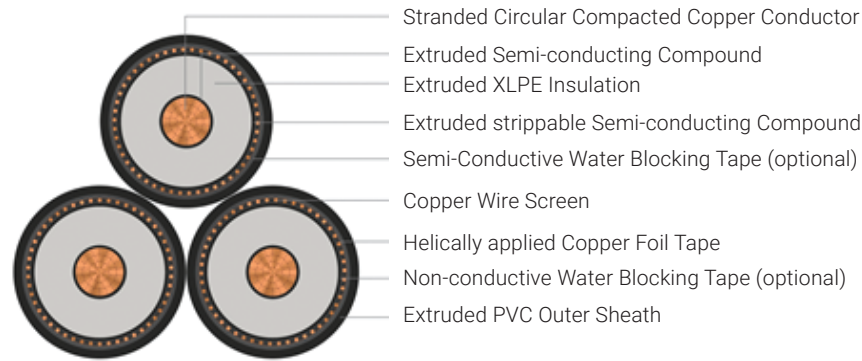

- Salient Features**
- Long life
 - UV resistant
 - Resistant to chemical exposure
 - Resistant to water (AD7/AD8 with HDPE)
 - Resistant to weather exposure
 - Termite resistant (Optional)

Application

POLYCAB MV 19/33 KV XLPE insulated with Copper conductor Triplex cable is suitable to use for power supply to wide networks i.e. Commercial, Industrial and Urban / Residential.

Voltage Rating

Nominal Voltage: 19/33 (36) kV

Operation Temperature

Min. installation temperature: 0°C
 Operating temperature: -25°C to +90°C
 Emergency operating temperature: 105°C
 (max. operation of 36hrs, at 3 periods for 12 consecutive months use)
 Max. Short Circuit Temperature: 250°C

Construction

- Conductor: Stranded Compacted Circular Copper conductor as per AS/NZS 1125
- Conductor Screen: Extruded Semi-conductive compound
- Insulation: XLPE
- Insulation Screen: Extruded Strippable Semi-conductive compound
- Longitudinal Water blocking : Water blocking tape above and below copper screen (Optional)
- Metallic Insulation Screen: Copper Wire Screen + helically applied copper tape (E/F current capacity – Based on requirement)
- Outer Sheath: Extruded Polyvinyl Chloride, Colour: Black
- Termite Protection: Polyamide (Nylon -12) (optional)
 (Alternative Sheath: PVC+HDPE Composite Sheath or PVC + Nylon + HDPE (composite sheath with anti-termite properties) or LSZH Outer sheath, and parameters will change accordingly)
 Three Single Core Cables twisted and assembled to form triplex formation

Bending Radius:

Fixed Installation: 12D (PVC) / 15D (HDPE) / 20D (Nylon)
 During Installation: 18D (PVC) / 25D (HDPE) / 30D (Nylon)

D is overall diameter of each cable

Standard and References:

AS/NZS 1429.1
 AS/NZS 1125
 AS/NZS 3808

High Voltage Test (kV AC)	Partial discharge test (kV AC)		Impulse test Voltage (kV peak)
	200% to rated voltage	150% to rated voltage	
63	38	29	200

Compliance

- Conductor resistance AS/NZS 1125
- Insulation resistance AS/NZS 1429.1
- Short Circuit Temp. IEC 60986



POLYCAB TRIPLEX MV AS/NZS 1429.1 19/33 (36) KV
MV Cable with Copper Conductor, XLPE Insulation, Copper Screen - Triplex

DIMENSIONAL CHARACTERISTICS:

Product Code	No. of Cores	Core Cross sectional Area	Nominal Diameter		
			Under metallic screen	Over metallic screen	Overall
	No.	mm ²	mm	mm	mm
MVNZ13CXUAPH001T050SAXXXX	3	50	29.1	33.0	72.0
MVNZ13CXUAPH001T070SAXXXX	3	70	30.8	35.0	75.0
MVNZ13CXUAPH001T095SAXXXX	3	95	32.3	37.0	79.0
MVNZ13CXUAPH001T120SAXXXX	3	120	33.9	38.0	82.0
MVNZ13CXUAPH001T150SAXXXX	3	150	35.3	40.0	86.0
MVNZ13CXUAPH001T185SAXXXX	3	185	37.0	42.0	90.0
MVNZ13CXUAPH001T240SAXXXX	3	240	39.3	44.0	95.0
MVNZ13CXUAPH001T300SAXXXX	3	300	41.3	46.0	100.0
MVNZ13CXUAPH001T400SAXXXX	3	400	44.1	49.0	106.0
MVNZ13CXUAPH001T500SAXXXX	3	500	47.5	53.0	114.0

- Above mentioned parameters are based on 3kA/sec earth fault current capacity of copper screen



OUR CERTIFICATION
 ISO 9001 | ISO 14001 | ISO 45001





OUR CERTIFICATION
 ISO 9001 | ISO 14001 | ISO 45001



POLYCAB TRIPLEX MV AS/NZS 1429.1 19/33 (36) KV
MV Cable with Copper Conductor, XLPE Insulation, Copper Screen - Triplex

ELECTRICAL CHARACTERISTICS:

No. of Cores	Core Cross sectional Area	Max. DC Resistance at 20°C	Max. AC Resistance at 90°C	Approx. Capacitance	Approx. Inductance	Approx. Reactance	Continuous Current Rating		
							Buried direct in ground	In a buried duct	In Air
									
No.	mm ²	Ω/km	Ω/km	μF/km	mH/km	Ω/km	Amps		
3 x 1	50	0.387	0.494	0.14	0.486	0.153	181	158	204
3 x 1	70	0.268	0.342	0.15	0.449	0.141	221	193	253
3 x 1	95	0.193	0.247	0.17	0.429	0.135	262	231	304
3 x 1	120	0.153	0.196	0.18	0.409	0.128	298	264	351
3 x 1	150	0.124	0.159	0.19	0.396	0.124	334	297	398
3 x 1	185	0.0991	0.127	0.21	0.382	0.120	377	336	455
3 x 1	240	0.0754	0.098	0.23	0.367	0.115	434	390	531
3 x 1	300	0.0601	0.079	0.25	0.354	0.111	489	441	606
3 x 1	400	0.047	0.063	0.27	0.341	0.107	553	501	696
3 x 1	500	0.0366	0.050	0.3	0.327	0.103	632	574	800

*: Current Ratings are based on IEC 60502-2 & IEC 60287, Max. Conductor Temperature at 90°C, Ambient temperature at 30°C in Air / at 20°C in Ground, Thermal resistivity of Soil 1.5 k.m/W & for earthenware ducts 1.2k.m/W and Depth of Laying 0.8m.

Current rating de-rating factors for other than 30°C ambient air temperature.

20	25	35	40	45	50	55	60
1.08	1.04	0.96	0.91	0.87	0.82	0.76	0.71

Current rating de-rating factors for other than 20°C ground temperature.

10	15	25	30	35	40	45	50
1.07	1.04	0.96	0.93	0.89	0.85	0.80	0.76

POLYCAB TRIPLEX MV AS/NZS 1429.1 19/33 (36) KV
MV Cable with Copper Conductor, XLPE Insulation, Copper Screen - Triplex

No. of Cores	Core Cross sectional Area	Max. pulling tension on conductor	Charging Current per phase	Zero sequence impedance	Electric Stress at Conductor Screen	Short circuit rating of Phase conductor
No.	mm ²	kN	Amps/Km	Ohms/Km	kV/mm	kA, 1 sec
3 x 1	50	3.5	0.84	1.7	4.1	7.2
3 x 1	70	4.9	0.9	1.5	3.9	10.0
3 x 1	95	6.7	1.01	1.4	3.7	13.6
3 x 1	120	8.4	1.07	1.4	3.6	17.1
3 x 1	150	10.5	1.13	1.3	3.5	21.4
3 x 1	185	13.0	1.25	1.3	3.4	26.4
3 x 1	240	16.8	1.37	1.3	3.3	34.3
3 x 1	300	21.0	1.49	1.2	3.2	42.8
3 x 1	400	28.0	1.61	1.2	3.1	56.9
3 x 1	500	35.0	1.79	1.2	3.0	71.5



OUR CERTIFICATION
 ISO 9001 | ISO 14001 | ISO 45001



OUR CERTIFICATION
 ISO 9001 | ISO 14001 | ISO 45001



POLYCAB TRIPLEX MV AS/NZS 1429.1 19/33 (36) KV
MV Cable with Aluminium Conductor, XLPE Insulation, Copper Screen - Triplex

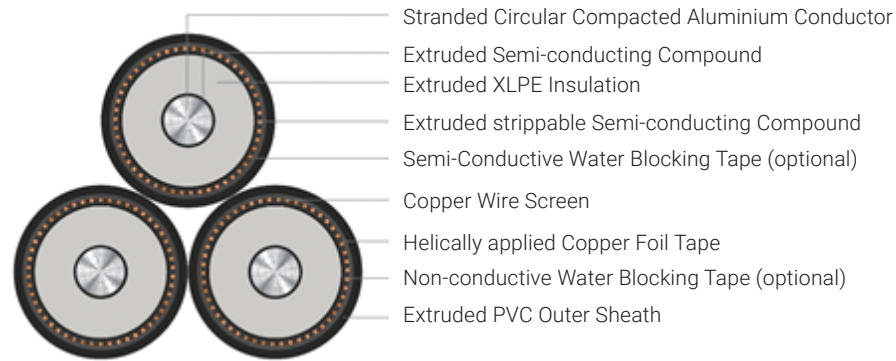

- Salient Features**
- Long life
 - UV resistant
 - Resistant to chemical exposure
 - Resistant to water (AD7/AD8 with HDPE)
 - Resistant to weather exposure

Application

POLYCAB MV 19/33 KV XLPE insulated with Aluminium conductor Triplex cable is suitable to use for power supply to wide networks i.e. Commercial, Industrial and Urban / Residential.

Voltage Rating

Nominal Voltage: 19/33 (36) kv

Operation Temperature

Min. installation temperature: 0°C
 Operating temperature: -25°C to +90°C
 Emergency operating temperature: 105°C
 (max. operation of 36hrs, at 3 periods for 12 consecutive months use)
 Max. Short Circuit Temperature: 250°C

Construction

- Conductor: Stranded Compacted Circular aluminium conductor as per AS/NZS 1125
- Conductor Screen: Extruded Semi-conductive compound
- Insulation: XLPE
- Insulation Screen: Extruded Strippable Semi-conductive compound
- Longitudinal Water blocking : Water blocking tape above and below copper screen (Optional)
- Metallic Insulation Screen: Copper Wire Screen + helically applied copper tape (E/F current capacity – Based on requirement)
- Outer Sheath: Extruded Polyvinyl Chloride, Colour: Black
- Termite Protection: Polyamide (Nylon -12) (optional)
 (Alternative Sheath: PVC+HDPE Composite Sheath or LSZH Outer sheath, and parameters will change accordingly)
 Three Single Core Cables twisted and assembled to form triplex formation

Bending Radius:

Fixed Installation: 12D (PVC) / 15D (HDPE)
 During Installation: 18D (PVC) / 25D (HDPE)

D is overall diameter of each cable

Standard and References:

AS/NZS 1429.1
 AS/NZS 1125
 AS/NZS 3808

High Voltage Test (kV AC)	Partial discharge test (kV AC)		Impulse test Voltage (kV peak)
	200% to rated voltage	150% to rated voltage	
63	38	29	200

Compliance

- Conductor resistance AS/NZS 1125
- Insulation resistance AS/NZS 1429.1
- Voltage test AS/NZS 1429.1



POLYCAB TRIPLEX MV AS/NZS 1429.1 19/33 (36) KV
MV Cable with Aluminium Conductor, XLPE Insulation, Copper Screen - Triplex

DIMENSIONAL CHARACTERISTICS:

Product Code	No. of Cores	Core Cross sectional Area	Nominal Diameter		
			Under metallic screen	Over metallic screen	Overall
	No.	mm ²	mm	mm	mm
MVNZ13AXUAPH001T050SAXXXX	3	50	29.1	33.0	72.0
MVNZ13AXUAPH001T070SAXXXX	3	70	30.7	35.0	75.0
MVNZ13AXUAPH001T095SAXXXX	3	95	32.3	37.0	79.0
MVNZ13AXUAPH001T120SAXXXX	3	120	33.9	38.0	82.0
MVNZ13AXUAPH001T150SAXXXX	3	150	35.2	40.0	86.0
MVNZ13AXUAPH001T185SAXXXX	3	185	36.9	42.0	89.0
MVNZ13AXUAPH001T240SAXXXX	3	240	39.2	44.0	95.0
MVNZ13AXUAPH001T300SAXXXX	3	300	41.4	46.0	100.0
MVNZ13AXUAPH001T400SAXXXX	3	400	44.1	49.0	106.0
MVNZ13AXUAPH001T500SAXXXX	3	500	47.5	53.0	114.0

- Above mentioned parameters are based on 3kA/sec earth fault current capacity of copper screen



OUR CERTIFICATION
 ISO 9001 | ISO 14001 | ISO 45001





OUR CERTIFICATION
 ISO 9001 | ISO 14001 | ISO 45001



POLYCAB TRIPLEX MV AS/NZS 1429.1 19/33 (36) KV
 MV Cable with Aluminium Conductor, XLPE Insulation, Copper Screen - Triplex

ELECTRICAL CHARACTERISTICS:

No. of Cores	Core Cross sectional Area	Max. DC Resistance at 20°C	Max. AC Resistance at 90°C	Approx. Capacitance	Approx. Inductance	Approx. Reactance	Continuous Current Rating		
							Buried direct in ground	In a buried duct	In Air
									
No.	mm ²	Ω/km	Ω/km	μF/km	mH/km	Ω/km	Amps		
3 x 1	50	0.641	0.822	0.14	0.486	0.153	140	122	158
3 x 1	70	0.443	0.568	0.15	0.450	0.141	171	150	196
3 x 1	95	0.32	0.411	0.17	0.429	0.135	203	179	236
3 x 1	120	0.253	0.325	0.18	0.409	0.128	232	205	273
3 x 1	150	0.206	0.265	0.19	0.397	0.125	260	231	309
3 x 1	185	0.164	0.211	0.21	0.383	0.120	294	262	355
3 x 1	240	0.125	0.161	0.23	0.367	0.115	340	305	415
3 x 1	300	0.1	0.129	0.25	0.354	0.111	384	346	475
3 x 1	400	0.0778	0.101	0.27	0.341	0.107	438	398	552
3 x 1	500	0.0605	0.080	0.3	0.327	0.103	505	460	646

*: Current Ratings are based on IEC 60502-2 & IEC 60287, Max. Conductor Temperature at 90°C, Ambient temperature at 30°C in Air / at 20°C in Ground, Thermal resistivity of Soil 1.5 k.m/W & for earthenware ducts 1.2k.m/W and Depth of Laying 0.8m.

Current rating de-rating factors for other than 30°C ambient air temperature.

20	25	35	40	45	50	55	60
1.08	1.04	0.96	0.91	0.87	0.82	0.76	0.71

Current rating de-rating factors for other than 20°C ground temperature.

10	15	25	30	35	40	45	50
1.07	1.04	0.96	0.93	0.89	0.85	0.80	0.76

POLYCAB TRIPLEX MV AS/NZS 1429.1 19/33 (36) KV
 MV Cable with Aluminium Conductor, XLPE Insulation, Copper Screen - Triplex

No. of Cores	Core Cross sectional Area	Max. pulling tension on conductor	Charging Current per phase	Zero sequence impedance	Electric Stress at Conductor Screen	Short circuit rating of Phase conductor
No.	mm ²	kN	Amps/Km	Ohms/Km	kV/mm	kA, 1 sec
3 x 1	50	2.5	0.84	2.0	4.1	4.7
3 x 1	70	3.5	0.9	1.7	3.9	6.6
3 x 1	95	4.8	1.01	1.6	3.7	9.0
3 x 1	120	6.0	1.07	1.5	3.6	11.3
3 x 1	150	7.5	1.13	1.4	3.5	14.2
3 x 1	185	9.3	1.25	1.4	3.4	17.4
3 x 1	240	12.0	1.37	1.3	3.3	22.6
3 x 1	300	15.0	1.49	1.3	3.2	28.3
3 x 1	400	20.0	1.61	1.3	3.1	37.6
3 x 1	500	25.0	1.79	1.2	3.0	47.2



OUR CERTIFICATION
 ISO 9001 | ISO 14001 | ISO 45001



OUR CERTIFICATION
 ISO 9001 | ISO 14001 | ISO 45001



POLYCAB TRIPLEX ANTI-TERMITE MV AS/NZS 1429.1 19/33 (36) KV
MV Cable with Aluminium Conductor, XLPE Insulation, Copper Screen - Triplex

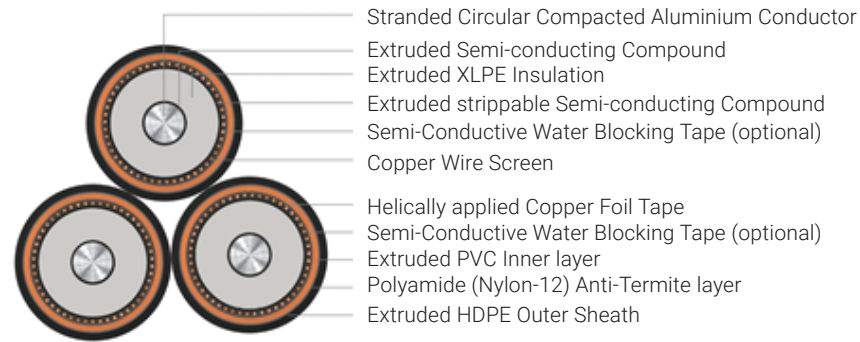

- Salient Features**
- Long life
 - UV resistant
 - Resistant to chemical exposure
 - Resistant to water (AD7/AD8 with HDPE)
 - Resistant to weather exposure
 - Termite resistant

Application
POLYCAB MV 19/33 KV XLPE insulated with Aluminium conductor Triplex cable is suitable to use for power supply to wide networks i.e. Commercial, Industrial and Urban / Residential.

Voltage Rating
Nominal Voltage: 19/33 (36) kV

Operation Temperature
Min. installation temperature: 0°C
Operating temperature: -25°C to +90°C
Emergency operating temperature: 105°C
(max. operation of 36hrs, at 3 periods for 12 consecutive months use)
Max. Short Circuit Temperature: 250°C

- Construction**
- Conductor: Stranded Compacted Circular aluminium conductor as per AS/NZS 1125
 - Conductor Screen: Extruded Semi-conductive compound
 - Insulation: XLPE
 - Insulation Screen: Extruded Strippable Semi-conductive compound
 - Longitudinal Water blocking : Water blocking tape above and below copper screen (Optional)
 - Metallic Insulation Screen: Copper Wire Screen + helically applied copper tape (E/F current capacity – Based on requirement)

- Composite sheath**
- Inner layer : Extruded Polyvinyl Chloride, Colour: Orange
 - Termite Protection: Polyamide (Nylon -12)
 - Outer layer: HDPE (Black)
- Three Single Core Cables twisted and assembled to form triplex formation

Bending Radius:
Fixed Installation: 20D
During Installation: 30D

D is diameter over nylon

Standard and References:
AS/NZS 1429.1
AS/NZS 1125
AS/NZS 3808

High Voltage Test (kV AC)	Partial discharge test (kV AC)		Impulse test Voltage (kV peak)
	200% to rated voltage	150% to rated voltage	
63	38	29	200

- Compliance**
- Conductor resistance AS/NZS 1125
 - Insulation resistance AS/NZS 1429.1
 - Voltage test AS/NZS 1429.1



POLYCAB TRIPLEX ANTI-TERMITE MV AS/NZS 1429.1 19/33 (36) KV
MV Cable with Aluminium Conductor, XLPE Insulation, Copper Screen - Triplex

DIMENSIONAL CHARACTERISTICS:



Product Code	No. of Cores	Core Cross sectional Area	Nominal Diameter		
			Under metallic screen	Over metallic screen	Overall
	No.	mm ²	mm	mm	mm
MVNZ13AXUAPH001T050SAXXXX	3	50	29.1	35.0	76.0
MVNZ13AXUAPH001T070SAXXXX	3	70	30.7	37.0	79.0
MVNZ13AXUAPH001T095SAXXXX	3	95	32.3	38.0	83.0
MVNZ13AXUAPH001T120SAXXXX	3	120	33.9	40.0	86.0
MVNZ13AXUAPH001T150SAXXXX	3	150	35.2	41.0	89.0
MVNZ13AXUAPH001T185SAXXXX	3	185	36.9	43.0	92.0
MVNZ13AXUAPH001T240SAXXXX	3	240	39.2	45.0	97.0
MVNZ13AXUAPH001T300SAXXXX	3	300	41.4	48.0	102.0
MVNZ13AXUAPH001T400SAXXXX	3	400	44.1	50.0	108.0
MVNZ13AXUAPH001T500SAXXXX	3	500	47.5	54.0	115.0

- Above mentioned parameters are based on 3kA/sec earth fault current capacity of copper screen



POLYCAB TRIPLEX ANTI-TERMITE MV AS/NZS 1429.1 19/33 (36) KV
MV Cable with Aluminium Conductor, XLPE Insulation, Copper Screen - Triplex

ELECTRICAL CHARACTERISTICS:

No. of Cores	Core Cross sectional Area	Max. DC Resistance at 20°C	Max. AC Resistance at 90°C	Approx. Capacitance	Approx. Inductance	Approx. Reactance	Continuous Current Rating		
							Buried direct in ground	In a buried duct	In Air
									
No.	mm ²	Ω/km	Ω/km	μF/km	mH/km	Ω/km	Amps		
3 x 1	50	0.641	0.82	0.14	0.497	0.156	140	122	158
3 x 1	70	0.443	0.57	0.15	0.460	0.145	171	150	196
3 x 1	95	0.32	0.41	0.17	0.438	0.138	203	179	236
3 x 1	120	0.253	0.32	0.18	0.417	0.131	232	205	273
3 x 1	150	0.206	0.26	0.19	0.404	0.127	260	231	309
3 x 1	185	0.164	0.21	0.21	0.390	0.122	294	262	355
3 x 1	240	0.125	0.16	0.23	0.373	0.117	340	305	415
3 x 1	300	0.1	0.13	0.25	0.358	0.113	384	346	475
3 x 1	400	0.0778	0.10	0.27	0.344	0.108	438	398	552
3 x 1	500	0.0605	0.08	0.3	0.330	0.104	505	460	646

*: Current Ratings are based on IEC 60502-2 & IEC 60287, Max. Conductor Temperature at 90°C, Ambient temperature at 30°C in Air / at 20°C in Ground, Thermal resistivity of Soil 1.5 k.m/W & for earthenware ducts 1.2k.m/W and Depth of Laying 0.8m.

Current rating de-rating factors for other than 30°C ambient air temperature.

20	25	35	40	45	50	55	60
1.08	1.04	0.96	0.91	0.87	0.82	0.76	0.71

Current rating de-rating factors for other than 20°C ground temperature.

10	15	25	30	35	40	45	50
1.07	1.04	0.96	0.93	0.89	0.85	0.80	0.76

POLYCAB TRIPLEX ANTI-TERMITE MV AS/NZS 1429.1 19/33 (36) KV
MV Cable with Aluminium Conductor, XLPE Insulation, Copper Screen - Triplex

No. of Cores	Core Cross sectional Area	Max. pulling tension on conductor	Charging Current per phase	Zero sequence impedance	Electric Stress at Conductor Screen	Short circuit rating of Phase conductor
No.	mm ²	kN	Amps/Km	Ohms/Km	kV/mm	kA, 1 sec
3 x 1	50	2.5	0.84	1.98	4.1	4.7
3 x 1	70	3.5	0.9	1.73	3.9	6.6
3 x 1	95	4.75	1.01	1.57	3.7	9.0
3 x 1	120	6	1.07	1.49	3.6	11.3
3 x 1	150	7.5	1.13	1.43	3.5	14.2
3 x 1	185	9.25	1.25	1.37	3.4	17.4
3 x 1	240	12	1.37	1.32	3.3	22.6
3 x 1	300	15	1.49	1.29	3.2	28.3
3 x 1	400	20	1.61	1.26	3.1	37.6
3 x 1	500	25	1.79	1.24	3.0	47.2



OUR CERTIFICATION
 ISO 9001 | ISO 14001 | ISO 45001



OUR CERTIFICATION
 ISO 9001 | ISO 14001 | ISO 45001



Polycab XLPE insulated round wire armored Power cable conforming to BS 5467 standard



These include low voltage and medium voltage armored cable conforming to the construction and performance of voltage rating 600/1000 V and 1900/3300 V as per BS 5467. These cables are suitable for use in fixed installations like industrial area, building or similar applications.

These cables are available in single and multicore with maximum operating conductor temperature of 90°C and maximum short circuit conductor temperature 250°C.

Conductor: The high conductivity annealed plain stranded copper conductor is produced in-house on state-of-the-art CONTIROD® line.

Insulation: The high insulation resistance cross-linked polyethylene thermoset insulation or ethylene propylene rubber is developed in-house.

Bedding: A protective barrier created between insulation and armour by extruded layer of polymeric material.

Armour: Made of steel or aluminium wire, the armour helps the cable to withstand mechanical & electrical stresses.

Sheath: Developed in-house, the PVC compound sheath can withstand mechanical abrasion.

The construction is based on the application and requirement of the user against BS 5467.



POLYCAB BS 5467 SC - Power Cable, 1.9/3.3 KV AC



POLYCAB BS 5467 MC (SHAPED CONDUCTOR) - Power Cable, 1.9/3.3 KV AC



POLYCAB BS 5467 MC - Power Cable, 1.9/3.3 KV AC

**POLYCAB BS 5467 MC
Power Cable, 1.9/3.3 KV AC**

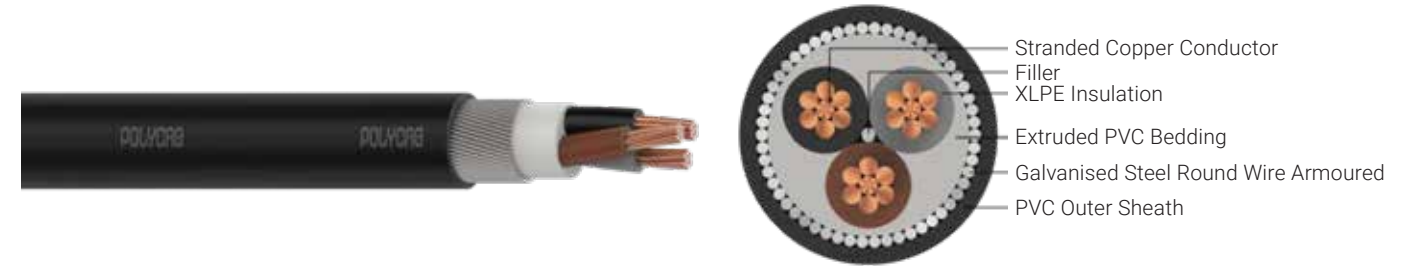

- Stranded Copper Conductor
- Filler
- XLPE Insulation
- Extruded PVC Bedding
- Galvanised Steel Round Wire Armoured
- PVC Outer Sheath

Application

POLYCAB BS 5467 MC stranded copper conductor with thermosetting insulation Multi core armored cable fulfils the requirement as per BS EN 5467. These cables are suitable for fixed installation in industrial area, buildings, Power network in underground, outdoor, indoor and similar application where mechanical protection is required.

Voltage Rating

1900/3300 V

Operation Temperature

Fixed: -15°C to +90° C

Short circuit temperature 250°C

Construction

- Annealed stranded copper conductor as per IEC 60228, class 2
- Insulated with cross linked type GP8 to BS 7655-1.3 or type GP 6 to BS 7655-1.2
- Bedding shall be extruded layer of polymeric material
- Armoured with Galvanised steel wire
- Sheathed with PVC conforming to Type 9 of BS 7655-4.2

Core Identification

Three Core – Brown, Black & Grey

Bending Radius

Fixed installation- 12 x Overall diameter

Standard and References:

- IEC 60228
- BS 7655-1.3/1.2
- BS 7655-4.2
- BS 5467
- EN 50265

Test Voltage

11250V AC at (20±5) °C

Compliance

- Conductor Resistance test - IEC 60228
- Insulation Resistance test - BS 5467
- Spark test - BS EN 5099
- Smoke emission test - BS EN 61034
- Flame propagation test - BS EN 50265-2-1

Approval

The Cable approved for BASEC, A British approval service for cables. The cable compliant with European regulation EN 50575, the construction Products Regulation(CPR).



POLYCAB BS 5467 MC
Power Cable, 1.9/3.3 KV AC

Product Code	Size of Conductor mm ²	Number of Core	Nominal insulation Thickness mm	Overall Diameter (Approx.) mm	Weight (Approx.) kg/km	POLYCAB/DOWEL Gland Size
MVBS10CXSWY2003C010S	10	3	2	26.9	1461	DBW-05A/DBF-05A
MVBS10CXSWY2003C016S	16	3	2	29.3	1774	DBW-05A/DBF-05A
MVBS10CXSWY2003C025S	25	3	2	32.2	2241	DBW-06A/DBF-06A
MVBS10CXSWY2003C035S	35	3	2	34.8	2695	DBW-07/DBF-07

- DBW – Weather proof series
- DBF – Flame proof series

Electrical Characteristics:

Current carrying capacity and Maximum Dc conductor resistance.

Nominal cross sectional area mm ²	Clipped direct	In free air on a perforated cable tray etc, horizontal or vertical at 30°C	Direct in ground or in ducting in ground, in or around buildings at 20°C	Max. resistance of conductor at 20°C Ω/km
	1 three-or 1 four-core cable, three-phase a.c. Amp.	1 three-or 1 four-core cable, three-phase a.c. Amp.	1 three-or 1 four-core cable, three-phase a.c. Amp.	
10	73	78	58	1.83
16	94	99	75	1.15
25	124	131	96	0.727
35	154	162	115	0.524

Ambient temperature: 30°C

Ground ambient temperature: 20°C

Conductor operating temperature: 90°C

Note* Where cables in this table are connected to equipment or accessories designed to operate at a temperature not exceeding 70°C thermoplastic insulated cable (table 4D4A) must be used.

The above table is in accordance with Table 4E4A of BS 7671.

De-Rating Factor

De-rating factor for 90°C thermosetting insulated cable

Ambient temperature	35°C to 50°C	55°C	60°C	65°C	70°C
De-rating factor	1	0.96	0.83	0.67	0.47

POLYCAB BS 5467 MC (SHAPED CONDUCTOR)
Power Cable, 1.9/3.3 KV AC

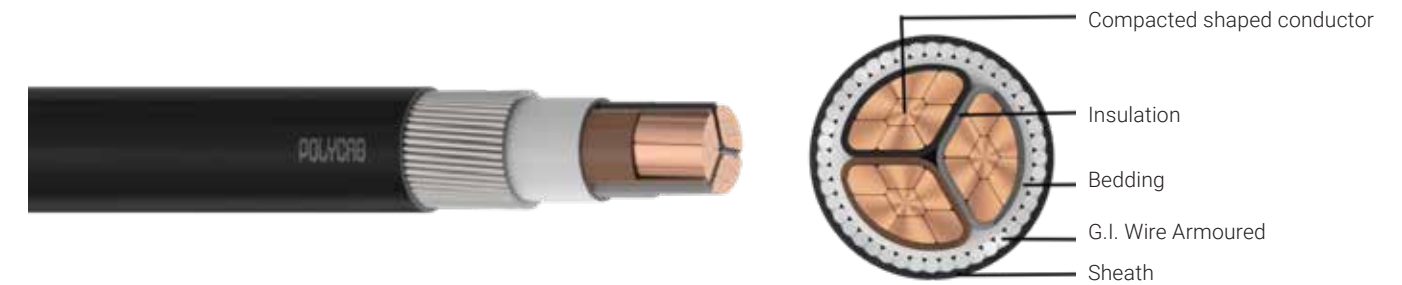

Application

POLYCAB BS 5467 MC Stranded sector shaped copper conductor thermosetting material insulated Multi core armoured cable fulfils the requirement as per BS EN 5467. These cables are suitable for fixed installation in industrial area, buildings, Power network in underground, outdoor, indoor and similar application where mechanical protection is required.

Voltage Rating

1900/3300 V

Operation Temperature

Fixed: -15°C to +90° C

Short circuit temperature 250°C

Construction

- Annealed compacted stranded copper conductor as per IEC 60228, class 2
- Insulated with cross linked type GP8 to BS 7655-1.3 or type GP 6 to BS 7655-1.2
- Bedding shall be extruded layer of polymeric material
- Armoured with Galvanised steel wire
- Sheathed with PVC conforming to Type 9 of BS 7655-4.2

Core Identification

Three Core – Brown, Black & Grey

Bending Radius

Fixed installation- 12 x Overall diameter

Standard and References:

- IEC 60228
- BS 7655-1.3/1.2
- BS 7655-4.2
- BS 5467
- EN 50265

Test Voltage

11250V AC at (20±5) °C

Compliance

- Conductor Resistance test - IEC 60228
- Insulation Resistance test - BS 5467
- Spark test - BS EN 5099
- Smoke emission test - BS EN 61034
- Flame propagation test - BS EN 50265-2-1

Approval

The Cable is approved for BASEC, A British approval service for cables.

The cable is compliant with European Regulation EN 50575, the construction Products Regulation(CPR).



OUR CERTIFICATION
ISO 9001 | ISO 14001 | ISO 45001



OUR CERTIFICATION
ISO 9001 | ISO 14001 | ISO 45001



POLYCAB BS 5467 MC (SHAPED CONDUCTOR)
Power Cable, 1.9/3.3 KV AC

Product Code	Size of Conductor mm ²	Nominal insulation Thickness mm	Overall Diameter (Approx.) mm	Weight (Approx.) kg/km	POLYCAB/DOWEL Gland Size
MVBS10CXSWY2003C035S	35	2	31.1	2251	DBW 06A/DBF 06A
MVBS10CXSWY2003C050S	50	2	34.7	3063	DBW 07/DBF 07
MVBS10CXSWY2003C070S	70	2	38	3799	DBW 08/DBF 08
MVBS10CXSWY2003C095S	95	2	41.4	4715	DBW 09/DBF 09
MVBS10CXSWY2003C120S	120	2	45.7	5973	DBW 09/DBF 09
MVBS10CXSWY2003C150S	150	2	48.5	7088	DBW 010A/DBF 010A
MVBS10CXSWY2003C185S	185	2	51.9	8286	DBW 010A/DBF 010A
MVBS10CXSWY2003C240S	240	2	56.9	10248	DBW 011/DBF 011
MVBS10CXSWY2003C300S	300	2	61.2	12258	DBW 012/DBF 012
MVBS10CXSWY2003C400S	400	2	66.6	14718	DBW 013A/DBF 013A

• DBW – Weather proof series • DBF – Flame proof series

Electrical Characteristics:

Current carrying capacity and Maximum Dc conductor resistance.

Nominal cross sectional area mm ²	Clipped direct	In free air on a perforated cable tray etc, horizontal or vertical at 30°C	Direct in ground or in ducting in ground, in or around buildings at 20°C	Max. resistance of conductor at 20°C Ω/km
	1 three-or 1 four-core cable, three-phase a.c. Amp.	1 three-or 1 four-core cable, three-phase a.c. Amp.	1 three-or 1 four-core cable, three-phase a.c. Amp.	
35	154	162	115	0.524
50	187	197	135	0.387
70	238	251	167	0.268
95	289	304	197	0.193
120	335	353	223	0.153
150	386	406	251	0.124
185	441	463	281	0.0991
240	520	546	324	0.0754
300	599	628	365	0.0601
400	-	-	-	0.047

Ambient temperature: 30°C Ground ambient temperature: 20°C Conductor operating temperature: 90°C

Note* Where cables in this table are connected to equipment or accessories designed to operate at a temperature not exceeding 70°C thermoplastic insulated cable (table 4D4A) must be used.

The above table is in accordance with Table 4E4A of BS 7671:2018

De-Rating Factor

De-rating factor for 90°C thermosetting insulated cable

Ambient temperature	35°C to 50°C	55°C	60°C	65°C	70°C
De-rating factor	1	0.96	0.83	0.67	0.47



OUR CERTIFICATION
ISO 9001 | ISO 14001 | ISO 45001



POLYCAB BS 5467 SC
Power Cable, 1.9/3.3 KV AC

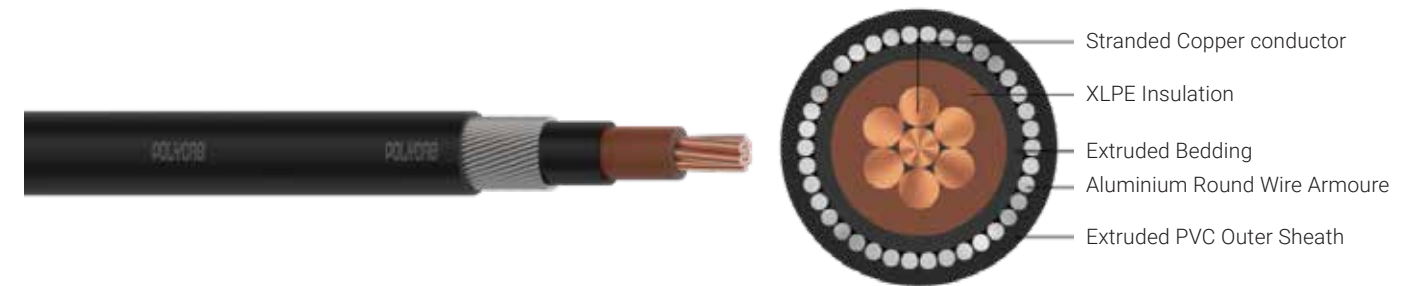

Application

POLYCAB BS 5467 SC stranded copper conductor thermosetting material insulated single core armoured cable fulfils the requirement as per BS EN 5467. These cables suitable for power network, underground in freedraining soil, outdoor and indoor applications, and cable ducting.

Voltage Rating

1900/3300 V

Operation Temperature

Maximum operating: +90° C
Short circuit temperature 250°C

Construction

- Annealed stranded copper conductor as per IEC 60228, class 2
- Insulated with cross linked type GP8 to BS 7655-1.3 or type GP 6 to BS 7655-1.2
- Bedding shall be extruded layer of polymeric material.
- Armoured with Aluminium round wire armoured.
- Sheathed with PVC conforming to requirements for Type 9 to BS 7655-4.2

Core Identification

Brown or Blue

Bending Radius

Fixed installation – 6 x Overall Diameter

Standard and References:

- IEC 60228
- BS 7655-1.3/1.2
- BS 7655-4.2
- BS 5467
- EN 50265

Test Voltage

11250V AC at (20±5) °C

Compliance

- Conductor Resistance test - IEC 60228
- Insulation Resistance test - BS 5467
- Spark test - BS EN 5099
- Smoke emission test - BS EN 61034
- Flame propagation test - BS EN 50265-2-1

Approval

The Cable approved for BASEC, A British approval service for cables.

The cable compliant with European Regulation EN 50575, the construction Products Regulation.



OUR CERTIFICATION
ISO 9001 | ISO 14001 | ISO 45001



POLYCAB BS 5467 SC
Power Cable, 1.9/3.3 KV AC

Product Code	Size of Conductor mm ²	Nominal insulation Thickness mm	Overall Diameter (Approx.) mm	Weight (Approx.) kg/km	POLYCAB/DOWEL Gland Size
MVBS10CXAWY2001C050S	50	2	20.6	896	DBW 03/DBF 03
MVBS10CXAWY2001C070S	70	2	22.4	1122	DBW 03/DBF 03
MVBS10CXAWY2001C095S	95	2	24.3	1405	DBW 04A/DBF 04A
MVBS10CXAWY2001C120S	120	2	27.2	1775	DBW 05A/DBF 05A
MVBS10CXAWY2001C150S	150	2	28.8	2102	DBW 05A/DBF 05A
MVBS10CXAWY2001C185S	185	2	30.8	2489	DBW 06A/DBF 06A
MVBS10CXAWY2001C240S	240	2	33.5	3104	DBW 07/DBF 07
MVBS10CXAWY2001C300S	300	2	36.1	3752	DBW 07/DBF 07
MVBS10CXAWY2001C400S	400	2	40.5	4895	DBW 08/DBF 08
MVBS10CXAWY2001C500S	500	2.2	44.2	5990	DBW 09/DBF 09
MVBS10CXAWY2001C630S	630	2.4	48.8	7432	DBW 010A/DBF 010A

• DBW – Weather proof series • DBF – Flame proof series

Electrical Characteristics:

Current carrying capacity and Maximum Dc conductor resistance.

Nominal cross sectional area mm ²	Reference Method C (clipped direct)	Reference Method E (in free air or on a perforated cable tray etc, horizontal or vertical)	Reference Method D (direct in ground or in ducting in ground, in or around buildings)	Maximum DC conductor resistance at 20°C Ω/km
	1 three-or 1 four-core cable, three-phase a.c. Amp.	1 three-or 1 four-core cable, three-phase a.c. Amp.	1 three-or 1 four-core cable, three-phase a.c. Amp.	
50	187	197	135	0.387
70	238	251	167	0.268
95	289	304	197	0.193
120	335	353	223	0.153
150	386	406	251	0.124
185	441	463	281	0.0991
240	520	546	324	0.0754
300	599	628	365	0.0601
400	-	-	-	0.047
500	-	-	-	0.0366
630	-	-	-	0.0283

Ambient temperature: 30°C Ambient ground temperature: 20°C, Conductor operating temperature: 90°C

Note * Where cables in this table are connected to equipment or accessories designed to operate at a temperature not exceeding 70°C, the current ratings given in the equivalent table for 70°C thermoplastic insulated cables (Table 4D4A) must be used.

The above table is in accordance with Table 4E4A of BS 7671:2018

De-Rating Factor

De-rating factor for 90°C thermosetting insulated cable

Ambient temperature	35°C to 50°C	55°C	60°C	65°C	70°C
De-rating factor	1	0.96	0.83	0.67	0.47



OUR CERTIFICATION
ISO 9001 | ISO 14001 | ISO 45001



OUR CERTIFICATION
ISO 9001 | ISO 14001 | ISO 45001



Polycab, XLPE Insulated Round Wire armoured Power Cable conforming to BS 6622



These include medium voltage armoured cable conforming to the construction and performance of voltage grade 3.8/6.6 (7.2) kV, 6.35/11 (12) kV, 8.7/15(17.5) kV, 12.7/22 (24) kV and 19/33 (36) kV as per BS 6622. These cables are suitable for use in power networks, underground and in cable ducts.

These cables are available in single and three core with maximum operating conductor temperature of 90°C and maximum short circuit conductor temperature 250°C.

Conductor: The high conductivity annealed plain stranded compacted aluminium/copper conductor is produced in-house with highly advanced machines.

Screen: Semi-conducting compound.

Insulation: High insulation resistance cross-linked polyethylene or EPR insulation.

Screen: Insulation screened by semi-conducting compound followed by copper tape.

Inner covering: Made from extruded polyvinyl chloride (PVC) or halogen free compound, the inner covering is placed between insulation screen and armour.

Armour: Made of steel or aluminium wire, the armour helps the cable to withstand mechanical & electrical stresses.

Sheath: Developed in-house, the PVC compound or medium density polyethylene sheath can withstand mechanical abrasion and weather.

The manufacturing process at Polycab follows stringent quality control principles, with additional testing at every stage. This ensures that only the highest quality product rolls out of the factory.

The construction based on the application and requirement of the user against BS 6622.



POLYCAB MV CU BS 6622 3.8/6.6 KV - Medium Voltage Armoured Cable, 3.8/6.6 (7.2) KV AC



POLYCAB MV CU BS 6622 6.35/11 KV - Medium Voltage Armoured Cable, 6.35/11 (12) KV AC



POLYCAB MV CU BS 6622 8.7/15 KV - Medium Voltage Armoured Cable, 8.7/15 (17.5) KV AC



POLYCAB MV CU BS 6622 12.7/22 KV - Medium Voltage Armoured Cable, 12.7/22 (24) KV AC



POLYCAB MV CU BS 6622 19/33 KV - Medium Voltage Armoured Cable, 19/33 (36) KV AC



POLYCAB MV AL BS 6622 3.8/6.6 KV - Medium Voltage Armoured Cable, 3.8/6.6 (7.2) KV AC



POLYCAB MV AL BS 6622 6.35/11 KV - Medium Voltage Armoured Cable, 6.35/11 (12) KV AC



POLYCAB MV AL BS 6622 8.7/15 KV - Medium Voltage Armoured Cable, 8.7/15 (17.5) KV AC



POLYCAB MV AL BS 6622 12.7/22 KV - Medium Voltage Armoured Cable, 12.7/22 (24) KV AC



POLYCAB MV AL BS 6622 19/33 KV - Medium Voltage Armoured Cable, 19/33 (36) KV AC

POLYCAB MV AL BS 6622 8.7/15 KV
Medium Voltage Armoured Cable, 8.7/15 (17.5) KV AC

Single Core



Three Core



Outstanding Features

- Flame retardant
- High life
- UV resistant
- Oil resistant

Application

POLYCAB MV AL BS 6622 8.7/15 KV XLPE insulated with aluminium conductor single & multi core cable is suitable to use for power networks, underground and in cable ducting.

Voltage Rating

Nominal Voltage: 8.7/15 (17.5) kV

Operation Temperature

Max. operating temperature: +90°C

Max. Short Circuit Temperature: 250°C

Construction

- Conductor: Circular Compacted aluminium conductor as per BS EN/IEC 60228, class 2
- Conductor Screen: Extruded Semi-conductive compound
- Insulation: XLPE as per BS 7655-1.3 or EPR as per BS 7655-1.2
- Non-Metallic Insulation Screen: Extruded Semi-conductive compound
- Metallic Insulation Screen: Copper tape screen
- Inner Covering: Extruded Polyvinyl Chloride or Halogen free compound
- Armour:
 - Single Core: Aluminium Round Wire Armoured (AWA)
 - Multi Core: Galvanised Steel Round Wire Armoured (SWA)
- Outer Sheath: Extruded Polyvinyl Chloride as per BS 7655-4.2 or Medium density Polyethylene as per BS 7655-10.1 Colour: Black

Standard and References:

BS EN/IEC 60228
BS 7655-1.3/1.2
BS 7655-4.2/10.1
BS 6622

Test Voltage

35kV AC

Impulse Test Voltage

Peak 112kV AC

Compliance

Conductor resistance BS EN/IEC 60228
Insulation resistance BS 6622
Flame Retardant test BS EN/IEC 60332-1-2
Partial Discharge test BS 6622

Approval



POLYCAB MV AL BS 6622 8.7/15 KV
Medium Voltage Armoured Cable, 8.7/15 (17.5) KV AC

Product Code	No. of Cores	Nominal Cross sectional Area	Nominal Diameter			Weight (Approx.)
			Under armour	Over armour screen	Overall	
	No.	mm ²	mm	mm	mm	Kg/Km
MVBS23AXAWY2001C070S	1	70	23.0	26.2	30.0	1100
MVBS23AXAWY2001C095S	1	95	24.8	28.0	32.0	1250
MVBS23AXAWY2001C120S	1	120	26.4	30.4	34.0	1500
MVBS23AXAWY2001C150S	1	150	28.5	32.5	37.0	1700
MVBS23AXAWY2001C185S	1	185	30.2	34.2	38.0	1850
MVBS23AXAWY2001C240S	1	240	32.6	36.6	41.0	2150
MVBS23AXAWY2001C300S	1	300	35.1	39.1	44.0	2500
MVBS23AXAWY2001C400S	1	400	38.3	43.3	48.0	3050
MVBS23AXAWY2001C500S	1	500	42.0	47.0	52.0	3600
MVBS23AXAWY2001C630S	1	630	45.4	50.4	56.0	4150
MVBS23AXAWY2001C800S	1	800	49.5	54.5	60.0	4900
MVBS23AXAWY2001C01KS	1	1000	54.2	59.2	65.0	5800
MVBS23AXSWY2003C070S	3	70	48.8	53.8	59.0	5350
MVBS23AXSWY2003C095S	3	95	52.6	57.6	64.0	6050
MVBS23AXSWY2003C120S	3	120	56.0	61.0	67.0	6650
MVBS23AXSWY2003C150S	3	150	59.7	64.7	71.0	7400
MVBS23AXSWY2003C185S	3	185	63.3	69.6	76.0	8950
MVBS23AXSWY2003C240S	3	240	69.1	75.4	82.0	10300
MVBS23AXSWY2003C300S	3	300	74.4	80.7	88.0	11600
MVBS23AXSWY2003C400S	3	400	81.4	87.7	96.0	13500
MVBS23AXSWY2003C500S	3	500	88.9	95.2	103.0	15600
MVBS23AXSWY2003C630S	3	630	96.1	102.4	111.0	17800



Electrical Characteristics:

No. of Cores	Nominal Cross sectional Area	Max. DC Resistance at 20°C	Max. AC Resistance at 90°C	Short circuit current rating	Capacitance (Approx.)	Inductance (Approx.)	Reactance (Approx.)
No.	mm ²	Ω/km	Ω/km	kA/s	μF/km	mH/km	Ω/km
1	70	0.443	0.568	6.61	0.22	0.40	0.13
1	95	0.320	0.411	8.98	0.24	0.38	0.12
1	120	0.253	0.325	11.34	0.27	0.37	0.12
1	150	0.206	0.265	14.17	0.29	0.36	0.11
1	185	0.164	0.211	17.48	0.32	0.35	0.11
1	240	0.125	0.161	22.68	0.35	0.33	0.10
1	300	0.100	0.129	28.35	0.39	0.32	0.10
1	400	0.0778	0.101	37.79	0.44	0.32	0.10
1	500	0.0605	0.080	47.24	0.522	0.256	0.080
1	630	0.0469	0.063	59.52	0.574	0.247	0.078
1	800	0.0367	0.051	75.59	0.638	0.239	0.075
1	1000	0.0291	0.042	94.48	0.704	0.232	0.073

No. of Cores	Nominal Cross sectional Area	Max. DC Resistance at 20°C	Max. AC Resistance at 90°C	Short circuit current rating	Capacitance (Approx.)	Inductance (Approx.)	Reactance (Approx.)
No.	mm ²	Ω/km	Ω/km	kA/s	μF/km	mH/km	Ω/km
3	70	0.443	0.568	6.61	0.22	0.34	0.11
3	95	0.320	0.411	8.98	0.24	0.32	0.10
3	120	0.253	0.325	11.34	0.27	0.31	0.10
3	150	0.206	0.265	14.17	0.29	0.30	0.09
3	185	0.164	0.211	17.48	0.32	0.29	0.09
3	240	0.125	0.161	22.68	0.35	0.28	0.09
3	300	0.100	0.129	28.35	0.39	0.27	0.09
3	400	0.0778	0.101	37.79	0.44	0.26	0.08
3	500	0.0605	0.080	47.24	0.48	0.256	0.080
3	630	0.0469	0.063	59.52	0.53	0.250	0.079

Current Carrying Capacity

No. of core	Nominal Cross sectional area	Continuous Current Rating					
		Buried direct in the ground		In single-way ducts		In air	
		Trefoil Amp.	Flat spaced Amp.	Trefoil ducts Amp.	Flat touching Amp.	Trefoil Amp.	Flat touching Amp.
No.	mm ²						
1	70	186	192	176	178	230	236
1	95	221	229	210	213	280	287
1	120	252	260	240	242	324	332
1	150	281	288	267	271	368	376
1	185	317	324	303	307	424	432
1	240	367	373	351	356	502	511
1	300	414	419	397	402	577	586
1	400	470	466	451	457	673	676
1	500	498	471	433	389	748	712
1	630	555	514	481	421	856	798
1	800	597	536	514	436	949	859
1	1000	643	565	550	457	1049	931

No. of core	Nominal Cross sectional area	Continuous current capacity		
		In ground at 20°C Amp.	In a buried duct Amp.	In air Amp.
No.	mm ²			
3	70	171	150	196
3	95	204	180	238
3	120	232	206	274
3	150	259	231	309
3	185	293	262	354
3	240	338	304	415
3	300	380	343	472
3	400	432	393	545
3	500	494	435	649

Maximum conductor temperature 90°C
 Ambient air temperature 30°C
 Ground temperature 20°C
 Depth of laying 0.8 m
 Thermal resistivity of soil 1.5 K.m/W
 Thermal resistivity of earthenware ducts 1.2 K.m/W

Current rating de-rating factors for other than 30°C ambient air temperature.

Air Temperature	20	25	35	40	45	50	55	60
De-rating factor	1.08	1.04	0.96	0.91	0.87	0.82	0.76	0.71

Current rating de-rating factors for other than 20°C ground temperature.

Ground Temperature	10	15	25	30	35	40	45	50
De-rating factor	1.07	1.04	0.96	0.93	0.89	0.85	0.8	0.76



OUR CERTIFICATION
ISO 9001 | ISO 14001 | ISO 45001



OUR CERTIFICATION
ISO 9001 | ISO 14001 | ISO 45001



POLYCAB MV AL BS 6622 3.8/6.6 KV
Medium Voltage Armoured Cable, 3.8/6.6 (7.2) KV AC

Single Core



Three Core



Outstanding Features

- Flame retardant
- High life
- UV resistant
- Oil resistant

Application

POLYCAB MV AL BS 6622 3.8/6.6 KV XLPE insulated with aluminium conductor single & multi core cable is suitable to use for power distribution for external and direct burial applications in power network system.

Voltage Rating

Nominal Voltage: 3.8/6.6 (7.2) kV

Operation Temperature

Max. operating temperature: +90°C
Max. Short Circuit Temperature: 250°C

Construction

- Conductor: Circular Compacted Aluminium conductor as per BS EN/IEC 60228, class 2
- Conductor Screen: Extruded Semi-conductive compound
- Insulation: XLPE as per BS 7655 – 1.3 or EPR as per BS 7655 – 1.2
- Non-Metallic Insulation Screen: Extruded Semiconductive compound
- Metallic Insulation Screen: Copper tape screen
- Inner Covering: Extruded Polyvinyl Chloride or Halogen free compound
- Armour:
Single Core: Aluminium Round Wire Armoured (AWA)
Multi Core: Galvanised Steel Round Wire Armoured (SWA)
- Outer Sheath: Extruded Polyvinyl Chloride as per BS 7655-4.2 or Medium density Polyethylene as per BS 7655-10.1 Colour: Black

Standard and References:

BS EN/IEC 60228
BS 7655 – 1.3/1.2
BS 7655-4.2/10.1
BS 6622

Test Voltage

15kV AC

Impulse Test Voltage

Peak 75kV AC

Compliance

Conductor resistance IEC 60228
Insulation resistance BS 6622
Flame Retardant test EN/IEC 60332-1-2
Partial Discharge test BS 6622

Approval



POLYCAB MV AL BS 6622 3.8/6.6 KV
Medium Voltage Armoured Cable, 3.8/6.6 (7.2) KV AC

Product Code	No. of Cores	Nominal Cross sectional Area	Nominal Diameter			Weight (Approx.)
			Under armour	Over armour screen	Overall	
	No.	mm ²	mm	mm	mm	Kg/Km
MVBS21AXAWY2001C070S	1	70	19.00	22.20	26.0	850
MVBS21AXAWY2001C095S	1	95	20.80	24.00	28.0	1000
MVBS21AXAWY2001C120S	1	120	22.40	25.60	29.5	1150
MVBS21AXAWY2001C150S	1	150	24.10	27.30	31.5	1300
MVBS21AXAWY2001C185S	1	185	25.80	29.00	33.0	1450
MVBS21AXAWY2001C240S	1	240	28.80	32.80	37.0	1850
MVBS21AXAWY2001C300S	1	300	31.70	35.70	40.5	2200
MVBS21AXAWY2001C400S	1	400	35.30	39.30	44.0	2650
MVBS21AXAWY2001C500S	1	500	39.00	44.00	49.0	3300
MVBS21AXAWY2001C630S	1	630	42.90	47.90	53.0	3900
MVBS21AXAWY2001C800S	1	800	46.90	51.90	57.5	4600
MVBS21AXAWY2001C01KS	1	1000	51.60	56.60	62.5	5450
MVBS21AXSWY2003C070S	3	70	39.70	44.70	50.0	4050
MVBS21AXSWY2003C095S	3	95	43.60	48.60	54.0	4700
MVBS21AXSWY2003C120S	3	120	46.90	51.90	58.0	5250
MVBS21AXSWY2003C150S	3	150	51.10	56.10	62.0	6050
MVBS21AXSWY2003C185S	3	185	54.70	59.70	66.0	6700
MVBS21AXSWY2003C240S	3	240	60.40	65.40	72.0	8000
MVBS21AXSWY2003C300S	3	300	67.10	73.40	80.0	10150
MVBS21AXSWY2003C400S	3	400	74.90	81.20	89.0	12100
MVBS21AXSWY2003C500S	3	500	82.00	88.30	96.0	14000
MVBS21AXSWY2003C630S	3	630	89.90	96.20	104.0	16400



OUR CERTIFICATION
ISO 9001 | ISO 14001 | ISO 45001



OUR CERTIFICATION
ISO 9001 | ISO 14001 | ISO 45001



Electrical Characteristics:

No. of Cores	Nominal Cross sectional Area	Max. DC Resistance at 20°C	Max. AC Resistance at 90°C	Short circuit current rating	Capacitance (Approx.)	Inductance (Approx.)	Reactance (Approx.)
No.	mm ²	Ω/km	Ω/km	kA/s	μF/km	mH/km	Ω/km
1	70	0.443	0.568	6.61	0.33	0.37	0.12
1	95	0.320	0.411	8.98	0.38	0.35	0.11
1	120	0.253	0.325	11.34	0.41	0.34	0.11
1	150	0.206	0.265	14.17	0.46	0.33	0.10
1	185	0.164	0.211	17.48	0.50	0.32	0.10
1	240	0.125	0.161	22.68	0.54	0.31	0.10
1	300	0.100	0.129	28.35	0.57	0.31	0.10
1	400	0.0778	0.101	37.79	0.61	0.30	0.09
1	500	0.0605	0.080	47.24	0.708	0.24	0.08
1	630	0.0469	0.063	59.52	0.784	0.24	0.07
1	800	0.0367	0.051	75.59	0.870	0.23	0.07
1	1000	0.0291	0.042	94.48	0.963	0.22	0.07

No. of Cores	Nominal Cross sectional Area	Max. DC Resistance at 20°C	Max. AC Resistance at 90°C	Short circuit current rating	Capacitance (Approx.)	Inductance (Approx.)	Reactance (Approx.)
No.	mm ²	Ω/km	Ω/km	kA/s	μF/km	mH/km	Ω/km
3	70	0.443	0.568	6.61	0.33	0.30	0.092
3	95	0.320	0.411	8.98	0.38	0.29	0.088
3	120	0.253	0.325	11.34	0.41	0.28	0.085
3	150	0.206	0.265	14.17	0.46	0.27	0.083
3	185	0.164	0.211	17.48	0.50	0.26	0.081
3	240	0.125	0.161	22.68	0.54	0.26	0.079
3	300	0.100	0.129	28.35	0.57	0.25	0.078
3	400	0.0778	0.101	37.79	0.61	0.25	0.077
3	500	0.0605	0.080	47.24	0.68	0.25	0.075
3	630	0.0469	0.063	59.52	0.75	0.25	0.074

Current Carrying Capacity

No. of core	Nominal Cross sectional area	Continuous Current Rating					
		Buried direct in the ground		In single-way ducts		In air	
		Trefoil Amp.	Flat spaced Amp.	Trefoil ducts Amp.	Flat touching Amp.	Trefoil Amp.	Flat touching Amp.
No.	mm ²						
1	70	186	192	176	178	230	236
1	95	221	229	210	213	280	287
1	120	252	260	240	242	324	332
1	150	281	288	267	271	368	376
1	185	317	324	303	307	424	432
1	240	367	373	351	356	502	511
1	300	414	419	397	402	577	586
1	400	470	466	451	457	673	676
1	500	498	471	433	389	748	712
1	630	555	513	481	421	855	798
1	800	596	535	514	435	949	858
1	1000	643	565	550	457	1049	931

No. of core	Nominal Cross sectional area	Continuous current capacity		
		In ground at 20°C Amp.	In a buried duct Amp.	In air Amp.
No.	mm ²			
3	70	171	150	196
3	95	204	180	238
3	120	232	206	274
3	150	259	231	309
3	185	293	262	354
3	240	338	304	415
3	300	380	343	472
3	400	432	393	545
3	500	494	435	649

Maximum conductor temperature 90°C
Ambient air temperature 30°C
Ground temperature 20°C
Depth of laying 0.8 m
Thermal resistivity of soil 1.5 K.m/W
Thermal resistivity of earthenware ducts 1.2 K.m/W

Current rating de-rating factors for other than 30°C ambient air temperature.

Air Temperature	20	25	35	40	45	50	55	60
De-rating factor	1.08	1.04	0.96	0.91	0.87	0.82	0.76	0.71

Current rating de-rating factors for other than 20°C ground temperature.

Ground Temperature	10	15	25	30	35	40	45	50
De-rating factor	1.07	1.04	0.96	0.93	0.89	0.85	0.8	0.76



POLYCAB MV AL BS 6622 6.35/11 KV
Medium Voltage Armoured Cable, 6.35/11 (12) KV AC

Single Core



Three Core



Outstanding Features

- Flame retardant
- High life
- UV resistant
- Oil resistant

Application

POLYCAB MV AL BS 6622 6.35/11 KV XLPE insulated with aluminium conductor single & multi core cable is suitable to use for power networks, underground and in cable ducting.

Voltage Rating

Nominal Voltage: 6.35/11 (12) kV

Operation Temperature

Max. operating temperature: +90°C
Max. Short Circuit Temperature: 250°C

Construction

- Conductor: Circular Compacted Aluminium conductor as per BS EN/IEC 60228, class 2
- Conductor Screen: Extruded Semi-conductive compound
- Insulation: XLPE as per BS 7655-1.3 or EPR as per BS 7655-1.2
- Non-Metallic Insulation Screen: Extruded Semi-conductive compound
- Metallic Insulation Screen: Copper tape screen
- Inner Covering: Extruded Polyvinyl Chloride or Halogen free compound
- Armour:
 - Single Core: Aluminium Round Wire Armoured (AWA)
 - Multi Core: Galvanised Steel Round Wire Armoured (SWA)
- Outer Sheath: Extruded Polyvinyl Chloride as per BS 7655-4.2 or Medium density Polyethylene as per BS 7655-10.1 Colour: Black

Standard and References:

BS EN/IEC 60228
BS 7655-1.3/1.2
BS 7655-4.2/10.1
BS 6622

Test Voltage

25.5kV AC

Impulse Test Voltage

Peak 95kV AC

Compliance

Conductor resistance BS EN/IEC 60228
Insulation resistance BS 6622
Flame Retardant test BS EN/IEC 60332-1-2
Partial Discharge test BS 6622

Approval



Bending Radius:

Single core cable
Fixed Installation: 15 x Overall diameter
Three core cable
Fixed Installation: 12 x Overall diameter



OUR CERTIFICATION
ISO 9001 | ISO 14001 | ISO 45001



POLYCAB MV AL BS 6622 6.35/11 KV
Medium Voltage Armoured Cable, 6.35/11 (12) KV AC

Product Code	No. of Cores	Nominal Cross sectional Area	Nominal Diameter			Weight (Approx.)
			Under armour	Over armour	Overall	
	No.	mm ²	mm	mm	mm	Kg/Km
MVBS22AXAWY2001C070S	1	70	20.8	24.0	28.0	950
MVBS22AXAWY2001C095S	1	95	22.6	25.8	30.0	1100
MVBS22AXAWY2001C120S	1	120	24.2	27.4	31.0	1250
MVBS22AXAWY2001C150S	1	150	25.9	29.1	33.0	1400
MVBS22AXAWY2001C185S	1	185	28.0	32.0	36.0	1700
MVBS22AXAWY2001C240S	1	240	30.4	34.4	39.0	1950
MVBS22AXAWY2001C300S	1	300	32.9	36.9	41.0	2250
MVBS22AXAWY2001C400S	1	400	36.1	40.1	45.0	2700
MVBS22AXAWY2001C500S	1	500	39.4	44.4	49.0	3300
MVBS22AXAWY2001C630S	1	630	43.2	48.2	53.0	3950
MVBS22AXAWY2001C800S	1	800	47.3	52.3	58.0	4650
MVBS22AXAWY2001C01KS	1	1000	52.0	57.0	63.0	5500
MVBS22AXSWY2003C070S	3	70	43.6	48.6	54.0	4600
MVBS22AXSWY2003C095S	3	95	47.5	52.5	58.0	5250
MVBS22AXSWY2003C120S	3	120	51.2	56.2	62.0	5900
MVBS22AXSWY2003C150S	3	150	55.0	60.0	66.0	6650
MVBS22AXSWY2003C185S	3	185	58.6	63.6	70.0	7350
MVBS22AXSWY2003C240S	3	240	63.9	70.2	77.0	9250
MVBS22AXSWY2003C300S	3	300	69.7	76.0	83.0	10700
MVBS22AXSWY2003C400S	3	400	76.6	82.9	90.0	12450
MVBS22AXSWY2003C500S	3	500	83.7	90.0	98.0	14400
MVBS22AXSWY2003C630S	3	630	91.4	97.7	106.0	16700



OUR CERTIFICATION
ISO 9001 | ISO 14001 | ISO 45001



Electrical Characteristics:

No. of Cores	Nominal Cross sectional Area	Max. DC Resistance at 20°C	Max. AC Resistance at 90°C	Short circuit current rating	Capacitance (Approx.)	Inductance (Approx.)	Reactance (Approx.)
No.	mm ²	Ω/km	Ω/km	kA/s	μF/km	mH/km	Ω/km
1	70	0.443	0.568	6.61	0.26	0.38	0.12
1	95	0.320	0.411	8.98	0.30	0.37	0.12
1	120	0.253	0.325	11.34	0.33	0.35	0.11
1	150	0.206	0.265	14.17	0.36	0.34	0.11
1	185	0.164	0.211	17.48	0.39	0.34	0.11
1	240	0.125	0.161	22.68	0.44	0.32	0.10
1	300	0.100	0.129	28.35	0.49	0.31	0.10
1	400	0.0778	0.101	37.79	0.55	0.30	0.09
1	500	0.0605	0.080	47.24	0.670	0.245	0.077
1	630	0.0469	0.063	59.52	0.739	0.239	0.075
1	800	0.0367	0.051	75.59	0.823	0.231	0.073
1	1000	0.0291	0.042	94.48	0.911	0.225	0.071

No. of Cores	Nominal Cross sectional Area	Max. DC Resistance at 20°C	Max. AC Resistance at 90°C	Short circuit current rating	Capacitance (Approx.)	Inductance (Approx.)	Reactance (Approx.)
No.	mm ²	Ω/km	Ω/km	kA/s	μF/km	mH/km	Ω/km
3	70	0.443	0.568	6.61	0.26	0.31	0.098
3	95	0.320	0.411	8.98	0.30	0.30	0.094
3	120	0.253	0.325	11.34	0.33	0.29	0.090
3	150	0.206	0.265	14.17	0.36	0.28	0.088
3	185	0.164	0.211	17.48	0.39	0.27	0.086
3	240	0.125	0.161	22.68	0.44	0.26	0.083
3	300	0.100	0.129	28.35	0.49	0.26	0.081
3	400	0.0778	0.101	37.79	0.55	0.25	0.078
3	500	0.0605	0.080	47.24	0.61	0.244	0.077
3	630	0.0469	0.063	59.52	0.67	0.239	0.075

Current Carrying Capacity

No. of core	Nominal Cross sectional area	Continuous Current Rating					
		Buried direct in the ground		In single-way ducts		In air	
		Trefoil Amp.	Flat spaced Amp.	Trefoil ducts Amp.	Flat touching Amp.	Trefoil Amp.	Flat touching Amp.
No.	mm ²						
1	70	186	192	176	178	230	236
1	95	221	229	210	213	280	287
1	120	252	260	240	242	324	332
1	150	281	288	267	271	368	376
1	185	317	324	303	307	424	432
1	240	367	373	351	356	502	511
1	300	414	419	397	402	577	586
1	400	470	466	451	457	673	676
1	500	498	471	433	389	748	712
1	630	555	514	481	421	856	798
1	800	597	536	514	436	949	859
1	1000	643	565	550	457	1049	931

No. of core	Nominal Cross sectional area	Continuous current capacity		
		In ground at 20°C Amp.	In a buried duct Amp.	In air Amp.
No.	mm ²			
3	70	171	150	196
3	95	204	180	238
3	120	232	206	274
3	150	259	231	309
3	185	293	262	354
3	240	338	304	415
3	300	380	343	472
3	400	432	393	545
3	500	494	435	649

Maximum conductor temperature 90°C
 Ambient air temperature 30°C
 Ground temperature 20°C
 Depth of laying 0.8 m
 Thermal resistivity of soil 1.5 K.m/W
 Thermal resistivity of earthenware ducts 1.2 K.m/W

Current rating de-rating factors for other than 30°C ambient air temperature.

Air Temperature	20	25	35	40	45	50	55	60
De-rating factor	1.08	1.04	0.96	0.91	0.87	0.82	0.76	0.71

Current rating de-rating factors for other than 20°C ground temperature.

Ground Temperature	10	15	25	30	35	40	45	50
De-rating factor	1.07	1.04	0.96	0.93	0.89	0.85	0.8	0.76



OUR CERTIFICATION
ISO 9001 | ISO 14001 | ISO 45001



OUR CERTIFICATION
ISO 9001 | ISO 14001 | ISO 45001



POLYCAB MV AL BS 6622 12.7/22 KV
Medium Voltage Armoured Cable, 12.7/22 (24) KV AC

Single Core



Three Core



Outstanding Features

- Flame retardant
- High life
- UV resistant
- Oil resistant

Application

POLYCAB MV AL BS 6622 12.7/22 KV XLPE insulated with aluminium conductor single & multi core cable is suitable to use for power networks, underground and in cable ducting.

Voltage Rating

Nominal Voltage: 12.7/22 (24) kV

Operation Temperature

Max. operating temperature: +90°C
Max. Short Circuit Temperature: 250°C

Construction

- Conductor: Circular Compacted aluminium conductor as per BS EN/IEC 60228, class 2
- Conductor Screen: Extruded Semi-conductive compound
- Insulation: XLPE as per BS 7655-1.3 or EPR as per BS 7655-1.2
- Non-Metallic Insulation Screen: Extruded Semi-conductive compound
- Metallic Insulation Screen: Copper tape screen
- Inner Covering: Extruded Polyvinyl Chloride or Halogen free compound
- Armour:
 - Single Core: Aluminium Round Wire Armoured (AWA)
 - Multi Core: Galvanised Steel Round Wire Armoured (SWA)
- Outer Sheath: Extruded Polyvinyl Chloride as per BS 7655-4.2 or Medium density polyethylene as per BS 7655-10.1, Colour: Black

Standard and References:

BS EN/IEC 60228
BS 7655-1.3/1.2
BS 7655-4.2/10.1
BS 6622

Test Voltage

51kV AC

Impulse Test Voltage

Peak 144kV AC

Compliance

Conductor resistance BS EN/IEC 60228
Insulation resistance BS 6622
Flame Retardant test BS EN/IEC 60332-1-2
Partial Discharge test BS 6622

Approval



Bending Radius:

Single core cable
Fixed Installation: 15 x Overall diameter
Three core cable
Fixed Installation: 12 x Overall diameter

POLYCAB MV AL BS 6622 12.7/22 KV
Medium Voltage Armoured Cable, 12.7/22 (24) KV AC

Product Code	No. of Cores	Nominal Cross sectional Area mm ²	Nominal Diameter			Weight (Approx.) Kg/Km
			Under armour mm	Over armour mm	Overall mm	
MVBS19AXAWY2001C070S	1	70	25.0	28.2	32.0	1250
MVBS19AXAWY2001C095S	1	95	26.8	30.8	35.0	1500
MVBS19AXAWY2001C120S	1	120	28.8	32.8	37.0	1700
MVBS19AXAWY2001C150S	1	150	30.5	34.5	39.0	1850
MVBS19AXAWY2001C185S	1	185	32.2	36.2	41.0	2050
MVBS19AXAWY2001C240S	1	240	34.6	38.6	43.0	2350
MVBS19AXAWY2001C300S	1	300	37.1	41.1	46.0	2650
MVBS19AXAWY2001C400S	1	400	40.7	45.7	51.0	3300
MVBS19AXAWY2001C500S	1	500	44.0	49.0	54.0	3850
MVBS19AXAWY2001C630S	1	630	47.4	52.4	58.0	4400
MVBS19AXAWY2001C800S	1	800	51.9	56.9	63.0	5200
MVBS19AXAWY2001C01KS	1	1000	56.2	61.2	67.0	6100
MVBS19AXSWY2003C070S	3	70	53.1	58.1	64.0	6000
MVBS19AXSWY2003C095S	3	95	56.9	61.9	68.0	6700
MVBS19AXSWY2003C120S	3	120	60.3	65.3	72.0	7350
MVBS19AXSWY2003C150S	3	150	64.4	70.7	78.0	9050
MVBS19AXSWY2003C185S	3	185	68.0	74.3	81.0	9850
MVBS19AXSWY2003C240S	3	240	73.4	79.7	87.0	11150
MVBS19AXSWY2003C300S	3	300	78.8	85.1	93.0	12500
MVBS19AXSWY2003C400S	3	400	85.7	92.0	100.0	14400
MVBS19AXAWY2003C500S	3	500	93.2	99.5	108.0	16550
MVBS19AXAWY2003C630S	3	630	100.5	106.8	116.0	18950



Electrical Characteristics:

No. of Cores	Nominal Cross sectional Area	Max. DC Resistance at 20°C	Max. AC Resistance at 90°C	Short circuit current rating	Capacitance (Approx.)	Inductance (Approx.)	Reactance (Approx.)
No.	mm ²	Ω/km	Ω/km	kA/s	μF/km	mH/km	Ω/km
1	70	0.443	0.568	6.61	0.19	0.41	0.13
1	95	0.320	0.411	8.98	0.21	0.40	0.13
1	120	0.253	0.325	11.34	0.23	0.38	0.12
1	150	0.206	0.265	14.17	0.25	0.37	0.12
1	185	0.164	0.211	17.48	0.27	0.36	0.11
1	240	0.125	0.161	22.68	0.30	0.34	0.11
1	300	0.100	0.129	28.35	0.33	0.33	0.10
1	400	0.0778	0.101	37.79	0.37	0.33	0.10
1	500	0.0605	0.080	47.24	0.439	0.264	0.083
1	630	0.0469	0.063	59.52	0.481	0.255	0.080
1	800	0.0367	0.051	75.59	0.533	0.247	0.078
1	1000	0.0291	0.042	94.48	0.588	0.239	0.075

No. of Cores	Nominal Cross sectional Area	Max. DC Resistance at 20°C	Max. AC Resistance at 90°C	Short circuit current rating	Capacitance (Approx.)	Inductance (Approx.)	Reactance (Approx.)
No.	mm ²	Ω/km	Ω/km	kA/s	μF/km	mH/km	Ω/km
3	70	0.443	0.568	6.61	0.19	0.35	0.11
3	95	0.320	0.411	8.98	0.21	0.34	0.11
3	120	0.253	0.325	11.34	0.23	0.32	0.10
3	150	0.206	0.265	14.17	0.25	0.31	0.10
3	185	0.164	0.211	17.48	0.27	0.30	0.10
3	240	0.125	0.161	22.68	0.30	0.29	0.09
3	300	0.100	0.129	28.35	0.33	0.28	0.09
3	400	0.0778	0.101	37.79	0.37	0.27	0.09
3	500	0.0605	0.080	47.24	0.41	0.27	0.08
3	630	0.0469	0.063	59.52	0.45	0.26	0.08

Current Carrying Capacity

No. of core	Nominal Cross sectional area	Continuous Current Rating					
		Buried direct in the ground		In single-way ducts		In air	
		Trefoil Amp.	Flat spaced Amp.	Trefoil ducts Amp.	Flat touching Amp.	Trefoil Amp.	Flat touching Amp.
No.	mm ²						
1	70	186	192	176	178	230	236
1	95	221	229	210	213	280	287
1	120	252	260	240	242	324	332
1	150	281	288	267	271	368	376
1	185	317	324	303	307	424	432
1	240	367	373	351	356	502	511
1	300	414	419	397	402	577	586
1	400	470	466	451	457	673	676
1	500	483	450	415	367	746	705
1	630	536	489	458	396	847	787
1	800	586	525	513	434	953	868
1	1000	618	549	538	450	1038	936

No. of core	Nominal Cross sectional area	Continuous current capacity		
		In ground at 20°C Amp.	In a buried duct Amp.	In air Amp.
No.	mm ²			
3	70	171	150	196
3	95	204	180	238
3	120	232	206	274
3	150	259	231	309
3	185	293	262	354
3	240	338	304	415
3	300	380	343	472
3	400	432	393	545
3	500	494	441	658

Maximum conductor temperature 90°C
 Ambient air temperature 30°C
 Ground temperature 20°C
 Depth of laying 0.8 m
 Thermal resistivity of soil 1.5 K.m/W
 Thermal resistivity of earthenware ducts 1.2 K.m/W

Current rating de-rating factors for other than 30°C ambient air temperature.

Air Temperature	20	25	35	40	45	50	55	60
De-rating factor	1.08	1.04	0.96	0.91	0.87	0.82	0.76	0.71

Current rating de-rating factors for other than 20°C ground temperature.

Ground Temperature	10	15	25	30	35	40	45	50
De-rating factor	1.07	1.04	0.96	0.93	0.89	0.85	0.8	0.76



OUR CERTIFICATION
ISO 9001 | ISO 14001 | ISO 45001



OUR CERTIFICATION
ISO 9001 | ISO 14001 | ISO 45001



POLYCAB MV AL BS 6622 19/33 KV
Medium Voltage Armoured Cable, 19/33 (36) KV AC

Single Core



Three Core



Outstanding Features

- Flame retardant
- High life
- UV resistant
- Oil resistant

Application

POLYCAB MV AL BS 6622 19/33 KV XLPE insulated with aluminium conductor single & multi core cable is suitable to use for power networks, underground and in cable ducting.

Voltage Rating

Nominal Voltage: 19/33 (36) kV

Operation Temperature

Max. operating temperature: +90°C
Max. Short Circuit Temperature: 250°C

Construction

- Conductor: Circular Compacted aluminium conductor as per BS EN/IEC 60228, class 2
- Conductor Screen: Extruded Semi-conductive compound
- Insulation: XLPE as per BS 7655-1.3 or EPR as per BS 7655-1.2
- Non-Metallic Insulation Screen: Extruded Semi-conductive compound
- Metallic Insulation Screen: Copper tape screen
- Inner Covering: Extruded Polyvinyl Chloride or Halogen free compound
- Armour:
 - Single Core: Aluminium Round Wire Armoured (AWA)
 - Multi Core: Galvanised Steel Round Wire Armoured (SWA)
- Outer Sheath: Extruded Polyvinyl Chloride as per BS 7655-4.2 or Medium density polyethylene as per BS 7655-10.1,
Colour: Black

Bending Radius:

Single core cable
Fixed Installation: 15 x Overall diameter
Three core cable
Fixed Installation: 12 x Overall diameter

Standard and References:

BS EN/IEC 60228
BS 7655-1.3/1.2
BS 7655-4.2/10.1
BS 6622

Test Voltage

76kV AC

Impulse Test Voltage

Peak 194kV AC

Compliance

Conductor resistance BS EN/IEC 60228
Insulation resistance BS 6622
Flame Retardant test BS EN/IEC 60332-1-2
Partial Discharge test BS 6622

Approval



POLYCAB MV AL BS 6622 19/33 KV
Medium Voltage Armoured Cable, 19/33 (36) KV AC

Product Code	No. of Cores	Nominal Cross sectional Area	Nominal Diameter			Weight (Approx.)
			Under armour	Over armour	Overall	
	No.	mm ²	mm	mm	mm	Kg/Km
MVBS20AXAWY2001C070S	1	70	30.4	34.4	39.0	1750
MVBS20AXAWY2001C095S	1	95	32.2	36.2	41.0	1900
MVBS20AXAWY2001C120S	1	120	33.8	37.8	42.0	2100
MVBS20AXAWY2001C150S	1	150	35.5	39.5	44.0	2300
MVBS20AXAWY2001C185S	1	185	37.2	42.2	47.0	2650
MVBS20AXAWY2001C240S	1	240	40.0	45.0	50.0	3000
MVBS20AXAWY2001C300S	1	300	42.5	47.5	53.0	3400
MVBS20AXAWY2001C400S	1	400	45.7	50.7	56.0	3850
MVBS20AXAWY2001C500S	1	500	49.0	54.0	60.0	4400
MVBS20AXAWY2001C630S	1	630	52.8	57.8	64.0	5100
MVBS20AXAWY2001C800S	1	800	56.9	61.9	68.0	5850
MVBS20AXAWY2001C01KS	1	1000	61.2	66.2	72.0	6750
MVBS20AXSWY2003C070S	3	70	64.3	70.6	77.0	8700
MVBS20AXSWY2003C095S	3	95	68.1	74.4	81.0	9450
MVBS20AXSWY2003C120S	3	120	71.5	77.8	85.0	10250
MVBS20AXSWY2003C150S	3	150	75.2	81.5	89.0	11100
MVBS20AXSWY2003C185S	3	185	78.8	85.1	93.0	12050
MVBS20AXSWY2003C240S	3	240	84.2	90.5	99.0	13400
MVBS20AXSWY2003C300S	3	300	90.0	96.3	105.0	15000
MVBS20AXSWY2003C400S	3	400	96.9	103.2	112.0	17050
MVBS20AXSWY2003C500S	3	500	104.0	110.3	120.0	19250
MVBS20AXSWY2003C630S	3	630	111.3	117.6	127.0	21700



OUR CERTIFICATION
ISO 9001 | ISO 14001 | ISO 45001



OUR CERTIFICATION
ISO 9001 | ISO 14001 | ISO 45001



Electrical Characteristics:

No. of Cores	Nominal Cross sectional Area	Max. DC Resistance at 20°C	Max. AC Resistance at 90°C	Short circuit current rating	Capacitance (Approx.)	Inductance (Approx.)	Reactance (Approx.)
No.	mm ²	Ω/km	Ω/km	kA/s	μF/km	mH/km	Ω/km
1	70	0.443	0.568	6.61	0.15	0.45	0.14
1	95	0.320	0.411	8.98	0.16	0.43	0.13
1	120	0.253	0.325	11.34	0.18	0.41	0.13
1	150	0.206	0.265	14.17	0.19	0.40	0.12
1	185	0.164	0.211	17.48	0.21	0.39	0.12
1	240	0.125	0.161	22.68	0.23	0.37	0.12
1	300	0.100	0.129	28.35	0.25	0.36	0.11
1	400	0.0778	0.101	37.79	0.28	0.35	0.11
1	500	0.0605	0.080	47.24	0.321	0.283	0.089
1	630	0.0469	0.063	59.52	0.350	0.274	0.086
1	800	0.0367	0.051	75.59	0.386	0.263	0.083
1	1000	0.0291	0.042	94.48	0.424	0.254	0.080

No. of Cores	Nominal Cross sectional Area	Max. DC Resistance at 20°C	Max. AC Resistance at 90°C	Short circuit current rating	Capacitance (Approx.)	Inductance (Approx.)	Reactance (Approx.)
No.	mm ²	Ω/km	Ω/km	kA/s	μF/km	mH/km	Ω/km
3	70	0.443	0.568	6.61	0.15	0.39	0.12
3	95	0.320	0.411	8.98	0.16	0.37	0.12
3	120	0.253	0.325	11.34	0.18	0.36	0.11
3	150	0.206	0.265	14.17	0.19	0.35	0.11
3	185	0.164	0.211	17.48	0.21	0.34	0.11
3	240	0.125	0.161	22.68	0.23	0.32	0.10
3	300	0.100	0.129	28.35	0.25	0.31	0.10
3	400	0.0778	0.101	37.79	0.28	0.30	0.09
3	500	0.0605	0.080	47.24	0.31	0.289	0.091
3	630	0.0469	0.063	59.52	0.33	0.281	0.088

Current Carrying Capacity

No. of core	Nominal Cross sectional area	Continuous Current Rating					
		Buried direct in the ground		In single-way ducts		In air	
		Trefoil Amp.	Flat spaced Amp.	Trefoil ducts Amp.	Flat touching Amp.	Trefoil Amp.	Flat touching Amp.
No.	mm ²						
1	70	186	192	176	178	230	236
1	95	221	229	210	213	280	287
1	120	252	260	240	242	324	332
1	150	281	288	267	271	368	376
1	185	317	324	303	307	424	432
1	240	367	373	351	356	502	511
1	300	414	419	397	402	577	586
1	400	470	466	451	457	673	676
1	500	483	450	415	367	746	705
1	630	536	489	458	396	847	787
1	800	586	525	513	434	953	868
1	1000	618	549	538	450	1038	936

No. of core	Nominal Cross sectional area	Continuous current capacity		
		In ground at 20°C Amp.	In a buried duct Amp.	In air Amp.
No.	mm ²			
3	70	171	150	196
3	95	204	180	238
3	120	232	206	274
3	150	259	231	309
3	185	293	262	354
3	240	338	304	415
3	300	380	343	472
3	400	432	393	545
3	500	494	441	658

Maximum conductor temperature 90°C
 Ambient air temperature 30°C
 Ground temperature 20°C
 Depth of laying 0.8 m
 Thermal resistivity of soil 1.5 K.m/W
 Thermal resistivity of earthenware ducts 1.2 K.m/W

Current rating de-rating factors for other than 30°C ambient air temperature.

Air Temperature	20	25	35	40	45	50	55	60
De-rating factor	1.08	1.04	0.96	0.91	0.87	0.82	0.76	0.71

Current rating de-rating factors for other than 20°C ground temperature.

Ground Temperature	10	15	25	30	35	40	45	50
De-rating factor	1.07	1.04	0.96	0.93	0.89	0.85	0.8	0.76



OUR CERTIFICATION
ISO 9001 | ISO 14001 | ISO 45001



OUR CERTIFICATION
ISO 9001 | ISO 14001 | ISO 45001



POLYCAB MV CU BS 6622 8.7/15 KV
Medium Voltage Armoured Cable, 8.7/15 (17.5) KV AC

Single Core



Three Core



Outstanding Features

- Flame retardant
- High life
- UV resistant
- Oil resistant

Application

POLYCAB MV CU BS 6622 8.7/15 KV XLPE insulated with copper conductor single & multi core cable is suitable to use for power networks, underground and in cable ducting.

Voltage Rating

Nominal Voltage: 8.7/15 (17.5) kV

Operation Temperature

Max. operating temperature: +90°C

Max. Short Circuit Temperature: 250°C

Construction

- Conductor: Circular Compacted Copper conductor as per BS EN/IEC 60228, class 2
- Conductor Screen: Extruded Semi-conductive compound
- Insulation: XLPE as per BS 7655-1.3 or EPR as per BS 7655-1.2
- Non-Metallic Insulation Screen: Extruded Semi-conductive compound
- Metallic Insulation Screen: Copper tape screen
- Inner Covering: Extruded Polyvinyl Chloride or Halogen free compound
- Armour:
 - Single Core: Aluminium Round Wire Armoured (AWA)
 - Multi Core: Galvanised Steel Round Wire Armoured (SWA)
- Outer Sheath: Extruded Polyvinyl Chloride as per BS 7655-4.2 or Medium density Polyethylene as per BS 7655-10.1
Colour: Black

Standard and References:

BS EN/IEC 60228
BS 7655-1.3/1.2
BS 7655-4.2/10.1
BS 6622

Test Voltage

35kV AC

Impulse Test Voltage

Peak 112kV AC

Compliance

Conductor resistance BS EN/IEC 60228
Insulation resistance BS 6622
Flame Retardant test BS EN/IEC 60332-1-2
Partial Discharge test BS 6622

Approval



POLYCAB MV CU BS 6622 8.7/15 KV
Medium Voltage Armoured Cable, 8.7/15 (17.5) KV AC

Product Code	No. of Cores	Nominal Cross sectional Area mm ²	Nominal Diameter			Weight (Approx.) Kg/Km
			Under armour mm	Over armour screen mm	Overall mm	
MVBS23CXAWY2001C070S	1	70	23.0	26.2	30.0	1600
MVBS23CXAWY2001C095S	1	95	24.8	28.0	32.0	1950
MVBS23CXAWY2001C120S	1	120	26.4	30.4	34.0	2200
MVBS23CXAWY2001C150S	1	150	28.5	32.5	37.0	2600
MVBS23CXAWY2001C185S	1	185	30.2	34.2	38.0	3000
MVBS23CXAWY2001C240S	1	240	32.6	36.6	41.0	3650
MVBS23CXAWY2001C300S	1	300	35.1	39.1	44.0	4350
MVBS23CXAWY2001C400S	1	400	38.3	43.3	48.0	5500
MVBS23CXAWY2001C500S	1	500	42.0	47.0	52.0	6700
MVBS23CXAWY2001C630S	1	630	45.4	50.4	56.0	8050
MVBS23CXAWY2001C800S	1	800	49.5	54.5	60.0	9800
MVBS23CXAWY2001C01KS	1	1000	54.2	59.2	65.0	11950
MVBS23CXSWY2003C070S	3	70	48.8	53.8	59.0	6650
MVBS23CXSWY2003C095S	3	95	52.6	57.6	64.0	7850
MVBS23CXSWY2003C120S	3	120	56.0	61.0	67.0	8950
MVBS23CXSWY2003C150S	3	150	59.7	64.7	71.0	10250
MVBS23CXSWY2003C185S	3	185	63.3	69.6	76.0	12450
MVBS23CXSWY2003C240S	3	240	69.1	75.4	82.0	14850
MVBS23CXSWY2003C300S	3	300	74.4	80.7	88.0	17350
MVBS23CXSWY2003C400S	3	400	81.4	87.7	96.0	21100
MVBS23CXSWY2003C500S	3	500	88.9	95.2	103.0	25300
MVBS23CXSWY2003C630S	3	630	96.1	102.4	111.0	29750



Electrical Characteristics:

No. of Cores	Nominal Cross sectional Area	Max. DC Resistance at 20°C	Max. AC Resistance at 90°C	Short circuit current rating	Capacitance (Approx.)	Inductance (Approx.)	Reactance (Approx.)
No.	mm ²	Ω/km	Ω/km	kA/s	μF/km	mH/km	Ω/km
1	70	0.268	0.342	10.02	0.22	0.40	0.13
1	95	0.193	0.247	13.59	0.24	0.38	0.12
1	120	0.153	0.196	17.17	0.27	0.37	0.12
1	150	0.124	0.159	21.46	0.29	0.36	0.11
1	185	0.0991	0.128	26.47	0.32	0.35	0.11
1	240	0.0754	0.098	34.34	0.35	0.33	0.10
1	300	0.0601	0.080	42.93	0.39	0.32	0.10
1	400	0.047	0.064	57.23	0.44	0.32	0.10
1	500	0.0366	0.052	71.54	0.522	0.256	0.080
1	630	0.0283	0.042	90.14	0.574	0.247	0.078
1	800	0.0221	0.036	114.47	0.638	0.239	0.075
1	1000	0.0176	0.032	143.08	0.704	0.232	0.073

No. of Cores	Nominal Cross sectional Area	Max. DC Resistance at 20°C	Max. AC Resistance at 90°C	Short circuit current rating	Capacitance (Approx.)	Inductance (Approx.)	Reactance (Approx.)
No.	mm ²	Ω/km	Ω/km	kA/s	μF/km	mH/km	Ω/km
3	70	0.268	0.342	10.02	0.22	0.34	0.11
3	95	0.193	0.247	13.59	0.24	0.32	0.10
3	120	0.153	0.196	17.17	0.27	0.31	0.10
3	150	0.124	0.159	21.46	0.29	0.30	0.09
3	185	0.0991	0.128	26.47	0.32	0.29	0.09
3	240	0.0754	0.098	34.34	0.35	0.28	0.09
3	300	0.0601	0.080	42.93	0.39	0.27	0.09
3	400	0.047	0.064	57.23	0.44	0.26	0.08
3	500	0.0366	0.052	71.54	0.48	0.256	0.080
3	630	0.0283	0.042	90.14	0.53	0.250	0.079

Current Carrying Capacity

No. of core	Nominal Cross sectional area	Continuous Current Rating					
		Buried direct in the ground		In single-way ducts		In air	
		Trefoil Amp.	Flat spaced Amp.	Trefoil ducts Amp.	Flat touching Amp.	Trefoil Amp.	Flat touching Amp.
No.	mm ²						
1	70	239	246	227	229	296	303
1	95	285	293	271	274	361	369
1	120	323	332	308	311	417	426
1	150	361	366	343	347	473	481
1	185	406	410	387	391	543	550
1	240	469	470	447	453	641	647
1	300	526	524	504	510	735	739
1	400	590	572	564	571	845	837
1	500	604	551	525	454	911	837
1	630	660	588	571	482	1023	919
1	800	690	594	594	484	1103	960
1	1000	726	615	621	497	1191	1020

No. of core	Nominal Cross sectional area	Continuous current capacity		
		In ground at 20°C Amp.	In a buried duct Amp.	In air Amp.
No.	mm ²			
3	70	220	194	253
3	95	263	232	307
3	120	298	264	352
3	150	332	296	397
3	185	374	335	453
3	240	431	387	529
3	300	482	435	599
3	400	541	492	683
3	500	610	537	804

Maximum conductor temperature 90°C
 Ambient air temperature 30°C
 Ground temperature 20°C
 Depth of laying 0.8 m
 Thermal resistivity of soil 1.5 K.m/W
 Thermal resistivity of earthenware ducts 1.2 K.m/W

Current rating de-rating factors for other than 30°C ambient air temperature.

Air Temperature	20	25	35	40	45	50	55	60
De-rating factor	1.08	1.04	0.96	0.91	0.87	0.82	0.76	0.71

Current rating de-rating factors for other than 20°C ground temperature.

Ground Temperature	10	15	25	30	35	40	45	50
De-rating factor	1.07	1.04	0.96	0.93	0.89	0.85	0.8	0.76



OUR CERTIFICATION
 ISO 9001 | ISO 14001 | ISO 45001



OUR CERTIFICATION
 ISO 9001 | ISO 14001 | ISO 45001



POLYCAB MV CU BS 6622 3.8/6.6 KV
Medium Voltage Armoured Cable, 3.8/6.6 (7.2) KV AC

Single Core



Three Core



Outstanding Features

- Flame retardant
- High life
- UV resistant
- Oil resistant

Application

POLYCAB MV CU BS 6622 3.8/6.6 KV XLPE insulated with copper conductor single & multi core cable is suitable to use for power distribution for external and direct burial applications in power network system.

Voltage Rating

Nominal Voltage: 3.8/6.6 (7.2) kV

Operation Temperature

Max. operating temperature: +90°C

Max. Short Circuit Temperature: 250°C

Construction

- Conductor: Circular Compacted Aluminium conductor as per BS EN/IEC 60228, class 2
- Conductor Screen: Extruded Semi-conductive compound
- Insulation: XLPE as per BS 7655 – 1.3 or EPR as per BS 7655 – 1.2
- Non-Metallic Insulation Screen: Extruded Semiconductive compound
- Metallic Insulation Screen: Copper tape screen
- Inner Covering: Extruded Polyvinyl Chloride or Halogen free compound
- Armour:
 - Single Core: Aluminium Round Wire Armoured (AWA)
 - Multi Core: Galvanised Steel Round Wire Armoured (SWA)
- Outer Sheath: Extruded Polyvinyl Chloride as per BS 7655-4.2 or Medium density Polyethylene as per BS 7655-10.1 Colour: Black

Standard and References:

BS EN/IEC 60228
BS 7655 – 1.3/1.2
BS 7655-4.2/10.1
BS 6622

Test Voltage

15kV AC

Impulse Test Voltage

Peak 75kV AC

Compliance

Conductor resistance IEC 60228
Insulation resistance BS 6622
Flame Retardant test EN/IEC 60332-1-2
Partial Discharge test BS 6622

Approval



POLYCAB MV CU BS 6622 3.8/6.6 KV
Medium Voltage Armoured Cable, 3.8/6.6 (7.2) KV AC

Product Code	No. of Cores	Nominal Cross sectional Area	Nominal Diameter			Weight (Approx.)
			Under armour	Over armour screen	Overall	
	No.	mm ²	mm	mm	mm	Kg/Km
MVBS21CXAWY2001C070S	1	70	19.00	22.20	26.0	1300
MVBS21CXAWY2001C095S	1	95	20.80	24.00	28.0	1550
MVBS21CXAWY2001C120S	1	120	22.40	25.60	29.5	1850
MVBS21CXAWY2001C150S	1	150	24.10	27.30	31.5	2200
MVBS21CXAWY2001C185S	1	185	25.80	29.00	33.0	2600
MVBS21CXAWY2001C240S	1	240	28.80	32.80	37.0	3350
MVBS21CXAWY2001C300S	1	300	31.70	35.70	40.5	4050
MVBS21CXAWY2001C400S	1	400	35.30	39.30	44.0	5050
MVBS21CXAWY2001C500S	1	500	39.00	44.00	49.0	6400
MVBS21CXAWY2001C630S	1	630	42.90	47.90	53.0	7750
MVBS21CXAWY2001C800S	1	800	46.90	51.90	57.5	9500
MVBS21CXAWY2001C01KS	1	1000	51.60	56.60	62.5	11600
MVBS21CXSWY2003C070S	3	70	39.70	44.70	50.0	5400
MVBS21CXSWY2003C095S	3	95	43.60	48.60	54.0	6500
MVBS21CXSWY2003C120S	3	120	46.90	51.90	58.0	7550
MVBS21CXSWY2003C150S	3	150	51.10	56.10	62.0	8900
MVBS21CXSWY2003C185S	3	185	54.70	59.70	66.0	10200
MVBS21CXSWY2003C240S	3	240	60.40	65.40	72.0	12400
MVBS21CXSWY2003C300S	3	300	67.10	73.40	80.0	15900
MVBS21CXSWY2003C400S	3	400	74.90	81.20	89.0	19650
MVBS21CXSWY2003C500S	3	500	82.00	88.30	96.0	23600
MVBS21CXSWY2003C630S	3	630	89.90	96.20	104.0	28400



Electrical Characteristics:

No. of Cores	Nominal Cross sectional Area	Max. DC Resistance at 20°C	Max. AC Resistance at 90°C	Short circuit current rating	Capacitance (Approx.)	Inductance (Approx.)	Reactance (Approx.)
No.	mm ²	Ω/km	Ω/km	kA/s	μF/km	mH/km	Ω/km
1	70	0.268	0.342	10.02	0.33	0.37	0.12
1	95	0.193	0.247	13.59	0.38	0.35	0.11
1	120	0.153	0.196	17.17	0.41	0.34	0.11
1	150	0.124	0.159	21.46	0.46	0.33	0.10
1	185	0.0991	0.128	26.47	0.50	0.32	0.10
1	240	0.0754	0.098	34.34	0.54	0.31	0.10
1	300	0.0601	0.080	42.93	0.57	0.31	0.10
1	400	0.047	0.064	57.23	0.61	0.30	0.09
1	500	0.0366	0.052	71.54	0.708	0.24	0.08
1	630	0.0283	0.042	90.14	0.784	0.24	0.07
1	800	0.0221	0.036	114.47	0.870	0.23	0.07
1	1000	0.0176	0.032	143.08	0.963	0.22	0.07

No. of Cores	Nominal Cross sectional Area	Max. DC Resistance at 20°C	Max. AC Resistance at 90°C	Short circuit current rating	Capacitance (Approx.)	Inductance (Approx.)	Reactance (Approx.)
No.	mm ²	Ω/km	Ω/km	kA/s	μF/km	mH/km	Ω/km
3	70	0.268	0.342	10.02	0.33	0.30	0.092
3	95	0.193	0.247	13.59	0.38	0.29	0.088
3	120	0.153	0.196	17.17	0.41	0.28	0.085
3	150	0.124	0.159	21.46	0.46	0.27	0.083
3	185	0.0991	0.128	26.47	0.50	0.26	0.081
3	240	0.0754	0.098	34.34	0.54	0.26	0.079
3	300	0.0601	0.080	42.93	0.57	0.25	0.078
3	400	0.047	0.064	57.23	0.61	0.25	0.077
3	500	0.0366	0.052	71.54	0.68	0.25	0.075
3	630	0.0283	0.042	90.14	0.75	0.25	0.074

Current Carrying Capacity

No. of core	Nominal Cross sectional area	Continuous Current Rating					
		Buried direct in the ground		In single-way ducts		In air	
		Trefoil Amp.	Flat spaced Amp.	Trefoil ducts Amp.	Flat touching Amp.	Trefoil Amp.	Flat touching Amp.
No.	mm ²						
1	70	239	246	227	229	296	303
1	95	285	293	271	274	361	369
1	120	323	332	308	311	417	426
1	150	361	366	343	347	473	481
1	185	406	410	387	391	543	550
1	240	469	470	447	453	641	647
1	300	526	524	504	510	735	739
1	400	590	572	564	571	845	837
1	500	604	550	525	454	911	837
1	630	660	586	571	482	1022	917
1	800	689	593	593	483	1102	959
1	1000	726	615	621	497	1191	1020

No. of core	Nominal Cross sectional area	Continuous current capacity		
		In ground at 20°C Amp.	In a buried duct Amp.	In air Amp.
No.	mm ²			
3	70	220	194	253
3	95	263	232	307
3	120	298	264	352
3	150	332	296	397
3	185	374	335	453
3	240	431	387	529
3	300	482	435	599
3	400	541	492	683
3	500	610	537	803

Maximum conductor temperature 90°C
Ambient air temperature 30°C
Ground temperature 20°C
Depth of laying 0.8 m
Thermal resistivity of soil 1.5 K.m/W
Thermal resistivity of earthenware ducts 1.2 K.m/W

Current rating de-rating factors for other than 30°C ambient air temperature.

Air Temperature	20	25	35	40	45	50	55	60
De-rating factor	1.08	1.04	0.96	0.91	0.87	0.82	0.76	0.71

Current rating de-rating factors for other than 20°C ground temperature.

Ground Temperature	10	15	25	30	35	40	45	50
De-rating factor	1.07	1.04	0.96	0.93	0.89	0.85	0.8	0.76



POLYCAB MV CU BS 6622 6.35/11 KV
Medium Voltage Armoured Cable, 6.35/11 (12) KV AC

Single Core



Three Core



Outstanding Features

- Flame retardant
- High life
- UV resistant
- Oil resistant

Application

POLYCAB MV BS 6622 6.35/11 KV XLPE insulated with copper conductor single & multi core cable is suitable to use for power networks, underground and in cable ducting.

Voltage Rating

Nominal Voltage: 6.35/11 (12) kV

Operation Temperature

Max. operating temperature: +90°C
Max. Short Circuit Temperature: 250°C

Construction

- Conductor: Circular Compacted Copper conductor as per BS EN/IEC 60228, class 2
- Conductor Screen: Extruded Semi-conductive compound
- Insulation: XLPE as per BS 7655-1.3 or EPR as per BS 7655-1.2
- Non-Metallic Insulation Screen: Extruded Semi-conductive compound
- Metallic Insulation Screen: Copper tape screen
- Inner Covering: Extruded Polyvinyl Chloride or Halogen free compound
- Armour:
 - Single Core: Aluminium Round Wire Armoured (AWA)
 - Multi Core: Galvanised Steel Round Wire Armoured (SWA)
- Outer Sheath: Extruded Polyvinyl Chloride as per BS 7655-4.2 or Medium density Polyethylene as per BS 7655-10.1 Colour: Black

Standard and References:

BS EN/IEC 60228
BS 7655-1.3/1.2
BS 7655-4.2/10.1
BS 6622

Test Voltage

25.5kV AC

Impulse Test Voltage

Peak 95kV AC

Compliance

Conductor resistance BS EN/IEC 60228
Insulation resistance BS 6622
Flame Retardant test BS EN/IEC 60332-1-2
Partial Discharge test BS 6622

Approval



POLYCAB MV CU BS 6622 6.35/11 KV
Medium Voltage Armoured Cable, 6.35/11 (12) KV AC

Product Code	No. of Cores	Nominal Cross sectional Area	Nominal Diameter			Weight (Approx.)
			Under armour	Over armour	Overall	
	No.	mm ²	mm	mm	mm	Kg/Km
MVBS22CXAWY2001C070S	1	70	20.8	24.0	28.0	1400
MVBS22CXAWY2001C095S	1	95	22.6	25.8	30.0	1700
MVBS22CXAWY2001C120S	1	120	24.2	27.4	31.0	2000
MVBS22CXAWY2001C150S	1	150	25.9	29.1	33.0	2350
MVBS22CXAWY2001C185S	1	185	28.0	32.0	36.0	2850
MVBS22CXAWY2001C240S	1	240	30.4	34.4	39.0	3450
MVBS22CXAWY2001C300S	1	300	32.9	36.9	41.0	4150
MVBS22CXAWY2001C400S	1	400	36.1	40.1	45.0	5150
MVBS22CXAWY2001C500S	1	500	39.4	44.4	49.0	6400
MVBS22CXAWY2001C630S	1	630	43.2	48.2	53.0	7800
MVBS22CXAWY2001C800S	1	800	47.3	52.3	58.0	9550
MVBS22CXAWY2001C01KS	1	1000	52.0	57.0	63.0	11650
MVBS22CXSWY2003C070S	3	70	43.6	48.6	54.0	5900
MVBS22CXSWY2003C095S	3	95	47.5	52.5	58.0	7050
MVBS22CXSWY2003C120S	3	120	51.2	56.2	62.0	8200
MVBS22CXSWY2003C150S	3	150	55.0	60.0	66.0	9500
MVBS22CXSWY2003C185S	3	185	58.6	63.6	70.0	10800
MVBS22CXSWY2003C240S	3	240	63.9	70.2	77.0	13800
MVBS22CXSWY2003C300S	3	300	69.7	76.0	83.0	16450
MVBS22CXSWY2003C400S	3	400	76.6	82.9	90.0	20000
MVBS22CXSWY2003C500S	3	500	83.7	90.0	98.0	24000
MVBS22CXSWY2003C630S	3	630	91.4	97.7	106.0	28650



Electrical Characteristics:

No. of Cores	Nominal Cross sectional Area	Max. DC Resistance at 20°C	Max. AC Resistance at 90°C	Short circuit current rating	Capacitance (Approx.)	Inductance (Approx.)	Reactance (Approx.)
No.	mm ²	Ω/km	Ω/km	kA/s	μF/km	mH/km	Ω/km
1	70	0.268	0.342	10.02	0.26	0.38	0.12
1	95	0.193	0.247	13.59	0.30	0.37	0.12
1	120	0.153	0.196	17.17	0.33	0.35	0.11
1	150	0.124	0.159	21.46	0.36	0.34	0.11
1	185	0.0991	0.128	26.47	0.39	0.34	0.11
1	240	0.0754	0.098	34.34	0.44	0.32	0.10
1	300	0.0601	0.080	42.93	0.49	0.31	0.10
1	400	0.047	0.064	57.23	0.55	0.30	0.09
1	500	0.0366	0.052	71.54	0.670	0.245	0.077
1	630	0.0283	0.042	90.14	0.739	0.239	0.075
1	800	0.0221	0.036	10.02	0.823	0.231	0.073
1	1000	0.0176	0.032	13.59	0.911	0.225	0.071

No. of Cores	Nominal Cross sectional Area	Max. DC Resistance at 20°C	Max. AC Resistance at 90°C	Short circuit current rating	Capacitance (Approx.)	Inductance (Approx.)	Reactance (Approx.)
No.	mm ²	Ω/km	Ω/km	kA/s	μF/km	mH/km	Ω/km
3	70	0.268	0.342	10.02	0.26	0.31	0.098
3	95	0.193	0.247	13.59	0.30	0.30	0.094
3	120	0.153	0.196	17.17	0.33	0.29	0.090
3	150	0.124	0.159	21.46	0.36	0.28	0.088
3	185	0.0991	0.128	26.47	0.39	0.27	0.086
3	240	0.0754	0.098	34.34	0.44	0.26	0.083
3	300	0.0601	0.080	42.93	0.49	0.26	0.081
3	400	0.047	0.064	57.23	0.55	0.25	0.078
3	500	0.0366	0.052	71.54	0.61	0.244	0.077
3	630	0.0283	0.042	90.14	0.67	0.239	0.075

Current Carrying Capacity

No. of core	Nominal Cross sectional area	Continuous Current Rating					
		Buried direct in the ground		In single-way ducts		In air	
		Trefoil Amp.	Flat spaced Amp.	Trefoil ducts Amp.	Flat touching Amp.	Trefoil Amp.	Flat touching Amp.
No.	mm ²						
1	70	239	246	227	229	296	303
1	95	285	293	271	274	361	369
1	120	323	332	308	311	417	426
1	150	361	366	343	347	473	481
1	185	406	410	387	391	543	550
1	240	469	470	447	453	641	647
1	300	526	524	504	510	735	739
1	400	590	572	564	571	845	837
1	500	604	551	525	454	911	837
1	630	660	588	571	482	1023	919
1	800	690	594	594	484	1103	960
1	1000	726	615	621	497	1191	1020

No. of core	Nominal Cross sectional area	Continuous current capacity		
		In ground at 20°C Amp.	In a buried duct Amp.	In air Amp.
No.	mm ²			
3	70	220	194	253
3	95	263	232	307
3	120	298	264	352
3	150	332	296	397
3	185	374	335	453
3	240	431	387	529
3	300	482	435	599
3	400	541	492	683
3	500	610	537	804

Maximum conductor temperature 90°C
 Ambient air temperature 30°C
 Ground temperature 20°C
 Depth of laying 0.8 m
 Thermal resistivity of soil 1.5 K.m/W
 Thermal resistivity of earthenware ducts 1.2 K.m/W

Current rating de-rating factors for other than 30°C ambient air temperature.

Air Temperature	20	25	35	40	45	50	55	60
De-rating factor	1.08	1.04	0.96	0.91	0.87	0.82	0.76	0.71

Current rating de-rating factors for other than 20°C ground temperature.

Ground Temperature	10	15	25	30	35	40	45	50
De-rating factor	1.07	1.04	0.96	0.93	0.89	0.85	0.8	0.76



OUR CERTIFICATION
 ISO 9001 | ISO 14001 | ISO 45001



OUR CERTIFICATION
 ISO 9001 | ISO 14001 | ISO 45001



POLYCAB MV CU BS 6622 12.7/22 KV
Medium Voltage Armoured Cable, 12.7/22 (24) KV AC

Single Core



Three Core



Outstanding Features

- Flame retardant
- High life
- UV resistant
- Oil resistant

Application

POLYCAB MV CU BS 6622 12.7/22 KV XLPE insulated with copper conductor single & multi core cable is suitable to use for power networks, underground and in cable ducting.

Voltage Rating

Nominal Voltage: 12.7/22 (24) kV

Operation Temperature

Max. operating temperature: +90°C

Max. Short Circuit Temperature: 250°C

Construction

- Conductor: Circular Compacted Copper conductor as per BS EN/IEC 60228, class 2
- Conductor Screen: Extruded Semi-conductive compound
- Insulation: XLPE as per BS 7655-1.3 or EPR as per BS 7655-1.2
- Non-Metallic Insulation Screen: Extruded Semi-conductive compound
- Metallic Insulation Screen: Copper tape screen
- Inner Covering: Extruded Polyvinyl Chloride or Halogen free compound
- Armour:
 - Single Core: Aluminium Round Wire Armoured (AWA)
 - Multi Core: Galvanised Steel Round Wire Armoured (SWA)
- Outer Sheath: Extruded Polyvinyl Chloride as per BS 7655-4.2 or Medium density polyethylene as per BS 7655-10.1, Colour: Black

Standard and References:

BS EN/IEC 60228
BS 7655-1.3/1.2
BS 7655-4.2/10.1
BS 6622

Test Voltage

51kV AC

Impulse Test Voltage

Peak 144kV AC

Compliance

Conductor resistance BS EN/IEC 60228
Insulation resistance BS 6622
Flame Retardant test BS EN/IEC 60332-1-2
Partial Discharge test BS 6622

Approval



Bending Radius:

Single core cable

Fixed Installation: 15 x Overall diameter

Three core cable

Fixed Installation: 12 x Overall diameter



OUR CERTIFICATION
ISO 9001 | ISO 14001 | ISO 45001



POLYCAB MV CU BS 6622 12.7/22 KV
Medium Voltage Armoured Cable, 12.7/22 (24) KV AC

Product Code	No. of Cores	Nominal Cross sectional Area mm ²	Nominal Diameter			Weight (Approx.) Kg/Km
			Under armour mm	Over armour mm	Overall mm	
MVBS19CXAWY2001C070S	1	70	25.0	28.2	32.0	1800
MVBS19CXAWY2001C095S	1	95	26.8	30.8	35.0	2100
MVBS19CXAWY2001C120S	1	120	28.8	32.8	37.0	2450
MVBS19CXAWY2001C150S	1	150	30.5	34.5	39.0	2800
MVBS19CXAWY2001C185S	1	185	32.2	36.2	41.0	3200
MVBS19CXAWY2001C240S	1	240	34.6	38.6	43.0	3850
MVBS19CXAWY2001C300S	1	300	37.1	41.1	46.0	4600
MVBS19CXAWY2001C400S	1	400	40.7	45.7	51.0	5850
MVBS19CXAWY2001C500S	1	500	44.0	49.0	54.0	7050
MVBS19CXAWY2001C630S	1	630	47.4	52.4	58.0	8400
MVBS19CXAWY2001C800S	1	800	51.9	56.9	63.0	10250
MVBS19CXAWY2001C01KS	1	1000	56.2	61.2	67.0	12400
MVBS19CXSWY2003C070S	3	70	53.1	58.1	64.0	7300
MVBS19CXSWY2003C095S	3	95	56.9	61.9	68.0	8500
MVBS19CXSWY2003C120S	3	120	60.3	65.3	72.0	9600
MVBS19CXSWY2003C150S	3	150	64.4	70.7	78.0	11900
MVBS19CXSWY2003C185S	3	185	68.0	74.3	81.0	13350
MVBS19CXSWY2003C240S	3	240	73.4	79.7	87.0	15700
MVBS19CXSWY2003C300S	3	300	78.8	85.1	93.0	18300
MVBS19CXSWY2003C400S	3	400	85.7	92.0	100.0	21750
MVBS19CXAWY2003C500S	3	500	93.2	99.5	108.0	26050
MVBS19CXAWY2003C630S	3	630	100.5	106.8	116.0	30900



OUR CERTIFICATION
ISO 9001 | ISO 14001 | ISO 45001



Electrical Characteristics:

No. of Cores	Nominal Cross sectional Area	Max. DC Resistance at 20°C	Max. AC Resistance at 90°C	Short circuit current rating	Capacitance (Approx.)	Inductance (Approx.)	Reactance (Approx.)
No.	mm ²	Ω/km	Ω/km	kA/s	μF/km	mH/km	Ω/km
1	70	0.268	0.342	10.02	0.19	0.41	0.13
1	95	0.193	0.247	13.59	0.21	0.40	0.13
1	120	0.153	0.196	17.17	0.23	0.38	0.12
1	150	0.124	0.159	21.46	0.25	0.37	0.12
1	185	0.0991	0.128	26.47	0.27	0.36	0.11
1	240	0.0754	0.098	34.34	0.30	0.34	0.11
1	300	0.0601	0.080	42.93	0.33	0.33	0.10
1	400	0.047	0.064	57.23	0.37	0.33	0.10
1	500	0.0366	0.052	71.54	0.439	0.264	0.083
1	630	0.0283	0.042	90.14	0.481	0.255	0.080
1	800	0.0221	0.036	10.02	0.533	0.247	0.078
1	1000	0.0176	0.032	13.59	0.588	0.239	0.075

No. of Cores	Nominal Cross sectional Area	Max. DC Resistance at 20°C	Max. AC Resistance at 90°C	Short circuit current rating	Capacitance (Approx.)	Inductance (Approx.)	Reactance (Approx.)
No.	mm ²	Ω/km	Ω/km	kA/s	μF/km	mH/km	Ω/km
3	70	0.268	0.342	10.02	0.19	0.35	0.11
3	95	0.193	0.247	13.59	0.21	0.34	0.11
3	120	0.153	0.196	17.17	0.23	0.32	0.10
3	150	0.124	0.159	21.46	0.25	0.31	0.10
3	185	0.0991	0.128	26.47	0.27	0.30	0.10
3	240	0.0754	0.098	34.34	0.30	0.29	0.09
3	300	0.0601	0.080	42.93	0.33	0.28	0.09
3	400	0.047	0.064	57.23	0.37	0.27	0.09
3	500	0.0366	0.052	71.54	0.41	0.27	0.08
3	630	0.0283	0.042	90.14	0.45	0.26	0.08

Current Carrying Capacity

No. of core	Nominal Cross sectional area	Continuous Current Rating					
		Buried direct in the ground		In single-way ducts		In air	
		Trefoil Amp.	Flat spaced Amp.	Trefoil ducts Amp.	Flat touching Amp.	Trefoil Amp.	Flat touching Amp.
No.	mm ²						
1	70	239	246	227	229	296	303
1	95	285	293	271	274	361	369
1	120	323	332	308	311	417	426
1	150	361	366	343	347	473	481
1	185	406	410	387	391	543	550
1	240	469	470	447	453	641	647
1	300	526	524	504	510	735	739
1	400	590	572	564	571	845	837
1	500	581	521	499	424	908	828
1	630	633	554	541	449	1012	905
1	800	679	583	594	483	1115	979
1	1000	694	596	605	489	1181	1032

No. of core	Nominal Cross sectional area	Continuous current capacity		
		In ground at 20°C Amp.	In a buried duct Amp.	In air Amp.
No.	mm ²			
3	70	220	194	253
3	95	263	232	307
3	120	298	264	352
3	150	332	296	397
3	185	374	335	453
3	240	431	387	529
3	300	482	435	599
3	400	541	492	683
3	500	608	548	820

Maximum conductor temperature 90°C
 Ambient air temperature 30°C
 Ground temperature 20°C
 Depth of laying 0.8 m
 Thermal resistivity of soil 1.5 K.m/W
 Thermal resistivity of earthenware ducts 1.2 K.m/W

Current rating de-rating factors for other than 30°C ambient air temperature.

Air Temperature	20	25	35	40	45	50	55	60
De-rating factor	1.08	1.04	0.96	0.91	0.87	0.82	0.76	0.71

Current rating de-rating factors for other than 20°C ground temperature.

Ground Temperature	10	15	25	30	35	40	45	50
De-rating factor	1.07	1.04	0.96	0.93	0.89	0.85	0.8	0.76



OUR CERTIFICATION
ISO 9001 | ISO 14001 | ISO 45001



OUR CERTIFICATION
ISO 9001 | ISO 14001 | ISO 45001



POLYCAB MV CU BS 6622 19/33 KV
Medium Voltage Armoured Cable, 19/33 (36) KV AC

Single Core



Three Core



Outstanding Features

- Flame retardant
- High life
- UV resistant
- Oil resistant

Application

POLYCAB MV CU BS 6622 19/33 KV XLPE insulated with copper conductor single & multi core cable is suitable to use for power networks, underground and in cable ducting.

Voltage Rating

Nominal Voltage: 19/33 (36) kV

Operation Temperature

Max. operating temperature: +90°C
Max. Short Circuit Temperature: 250°C

Construction

- Conductor: Circular Compacted Copper conductor as per BS EN/IEC 60228, class 2
- Conductor Screen: Extruded Semi-conductive compound
- Insulation: XLPE as per BS 7655-1.3 or EPR as per BS 7655-1.2
- Non-Metallic Insulation Screen: Extruded Semi-conductive compound
- Metallic Insulation Screen: Copper tape screen
- Inner Covering: Extruded Polyvinyl Chloride or Halogen free compound
- Armour:
 - Single Core: Aluminium Round Wire Armoured (AWA)
 - Multi Core: Galvanised Steel Round Wire Armoured (SWA)
- Outer Sheath: Extruded Polyvinyl Chloride as per BS 7655-4.2 or Medium density polyethylene as per BS 7655-10.1, Colour: Black

Standard and References:

BS EN/IEC 60228
BS 7655-1.3/1.2
BS 7655-4.2/10.1
BS 6622

Test Voltage

76kV AC

Impulse Test Voltage

Peak 194kV AC

Compliance

Conductor resistance BS EN/IEC 60228
Insulation resistance BS 6622
Flame Retardant test BS EN/IEC 60332-1-2
Partial Discharge test BS 6622

Approval



POLYCAB MV CU BS 6622 19/33 KV
Medium Voltage Armoured Cable, 19/33 (36) KV AC

Product Code	No. of Cores	Nominal Cross sectional Area	Nominal Diameter			Weight (Approx.)
			Under armour	Over armour	Overall	
	No.	mm ²	mm	mm	mm	Kg/Km
MVBS20CXAWY2001C070S	1	70	30.4	34.4	39.0	2200
MVBS20CXAWY2001C095S	1	95	32.2	36.2	41.0	2500
MVBS20CXAWY2001C120S	1	120	33.8	37.8	42.0	2850
MVBS20CXAWY2001C150S	1	150	35.5	39.5	44.0	3250
MVBS20CXAWY2001C185S	1	185	37.2	42.2	47.0	3800
MVBS20CXAWY2001C240S	1	240	40.0	45.0	50.0	4550
MVBS20CXAWY2001C300S	1	300	42.5	47.5	53.0	5300
MVBS20CXAWY2001C400S	1	400	45.7	50.7	56.0	6400
MVBS20CXAWY2001C500S	1	500	49.0	54.0	60.0	7600
MVBS20CXAWY2001C630S	1	630	52.8	57.8	64.0	9050
MVBS20CXAWY2001C800S	1	800	56.9	61.9	68.0	10900
MVBS20CXAWY2001C01KS	1	1000	61.2	66.2	72.0	13050
MVBS20CXSWY2003C070S	3	70	64.3	70.6	77.0	10000
MVBS20CXSWY2003C095S	3	95	68.1	74.4	81.0	11250
MVBS20CXSWY2003C120S	3	120	71.5	77.8	85.0	12550
MVBS20CXSWY2003C150S	3	150	75.2	81.5	89.0	13950
MVBS20CXSWY2003C185S	3	185	78.8	85.1	93.0	15550
MVBS20CXSWY2003C240S	3	240	84.2	90.5	99.0	17950
MVBS20CXSWY2003C300S	3	300	90.0	96.3	105.0	20800
MVBS20CXSWY2003C400S	3	400	96.9	103.2	112.0	24550
MVBS20CXSWY2003C500S	3	500	104.0	110.3	120.0	28800
MVBS20CXSWY2003C630S	3	630	111.3	117.6	127.0	33650



Electrical Characteristics:

No. of Cores	Nominal Cross sectional Area	Max. DC Resistance at 20°C	Max. AC Resistance at 90°C	Short circuit current rating	Capacitance (Approx.)	Inductance (Approx.)	Reactance (Approx.)
No.	mm ²	Ω/km	Ω/km	kA/s	μF/km	mH/km	Ω/km
1	70	0.268	0.342	10.02	0.15	0.45	0.14
1	95	0.193	0.247	13.59	0.16	0.43	0.13
1	120	0.153	0.196	17.17	0.18	0.41	0.13
1	150	0.124	0.159	21.46	0.19	0.40	0.12
1	185	0.0991	0.128	26.47	0.21	0.39	0.12
1	240	0.0754	0.098	34.34	0.23	0.37	0.12
1	300	0.0601	0.080	42.93	0.25	0.36	0.11
1	400	0.047	0.064	57.23	0.28	0.35	0.11
1	500	0.0366	0.052	71.54	0.321	0.283	0.089
1	630	0.0283	0.042	90.14	0.350	0.274	0.086
1	800	0.0221	0.036	10.02	0.386	0.263	0.083
1	1000	0.0176	0.032	13.59	0.424	0.254	0.080

No. of Cores	Nominal Cross sectional Area	Max. DC Resistance at 20°C	Max. AC Resistance at 90°C	Short circuit current rating	Capacitance (Approx.)	Inductance (Approx.)	Reactance (Approx.)
No.	mm ²	Ω/km	Ω/km	kA/s	μF/km	mH/km	Ω/km
3	70	0.268	0.342	10.02	0.15	0.39	0.12
3	95	0.193	0.247	13.59	0.16	0.37	0.12
3	120	0.153	0.196	17.17	0.18	0.36	0.11
3	150	0.124	0.159	21.46	0.19	0.35	0.11
3	185	0.0991	0.128	26.47	0.21	0.34	0.11
3	240	0.0754	0.098	34.34	0.23	0.32	0.10
3	300	0.0601	0.080	42.93	0.25	0.31	0.10
3	400	0.047	0.064	57.23	0.28	0.30	0.09
3	500	0.0366	0.052	71.54	0.31	0.289	0.091
3	630	0.0283	0.042	90.14	0.33	0.281	0.088

Current Carrying Capacity

No. of core	Nominal Cross sectional area	Continuous Current Rating					
		Buried direct in the ground		In single-way ducts		In air	
		Trefoil Amp.	Flat spaced Amp.	Trefoil ducts Amp.	Flat touching Amp.	Trefoil Amp.	Flat touching Amp.
No.	mm ²						
1	70	239	246	227	229	296	303
1	95	285	293	271	274	361	369
1	120	323	332	308	311	417	426
1	150	361	366	343	347	473	481
1	185	406	410	387	391	543	550
1	240	469	470	447	453	641	647
1	300	526	524	504	510	735	739
1	400	590	572	564	571	845	837
1	500	581	521	499	424	908	828
1	630	633	554	541	449	1012	905
1	800	679	583	594	483	1115	979
1	1000	694	596	605	489	1181	1032

No. of core	Nominal Cross sectional area	Continuous current capacity		
		In ground at 20°C Amp.	In a buried duct Amp.	In air Amp.
No.	mm ²			
3	70	220	194	253
3	95	263	232	307
3	120	298	264	352
3	150	332	296	397
3	185	374	335	453
3	240	431	387	529
3	300	482	435	599
3	400	541	492	683
3	500	608	548	820

Maximum conductor temperature 90°C
 Ambient air temperature 30°C
 Ground temperature 20°C
 Depth of laying 0.8 m
 Thermal resistivity of soil 1.5 K.m/W
 Thermal resistivity of earthenware ducts 1.2 K.m/W

Current rating de-rating factors for other than 30°C ambient air temperature.

Air Temperature	20	25	35	40	45	50	55	60
De-rating factor	1.08	1.04	0.96	0.91	0.87	0.82	0.76	0.71

Current rating de-rating factors for other than 20°C ground temperature.

Ground Temperature	10	15	25	30	35	40	45	50
De-rating factor	1.07	1.04	0.96	0.93	0.89	0.85	0.8	0.76



OUR CERTIFICATION
ISO 9001 | ISO 14001 | ISO 45001



OUR CERTIFICATION
ISO 9001 | ISO 14001 | ISO 45001



Polycab XLPE Insulated Round Wire Armored Power Cable conforming to BS 6724 standard



These include low voltage and medium voltage armoured cable conforming to the construction and performance of voltage rating 600/1000 V and 1900/3300 V as per BS 6724. These cables emit extremely low levels of smoke and fumes when exposed to fire, thus making them suitable for use in public areas. The cables are available in single and multicore with maximum conductor operating temperature of 90°C and maximum conductor short circuit temperature 250°C.

Conductor: The high conductivity annealed plain stranded copper conductor is produced in-house on state-of-the-art CONTIROD® line.

Insulation: The high insulation resistance; made of cross-linked polyethylene thermoset insulation, or ethylene propylene rubber, or cross linked polyolefin, is developed in-house.

Bedding: A protective barrier created between insulation and armour by extruded layer of polymeric material.
Armour: Made of steel or aluminium wire, the armour helps the cable to withstand mechanical & electrical stresses.

Sheath: Developed in-house, the thermoplastic compound Type LTS1 emits low levels of smoke and corrosive gases when exposed to fire.

The construction is based on the application and requirement of the user against BS 6724.



POLYCAB BS 6724 MC SWA LSZH (SHAPED CONDUCTOR)
- Power Cable, 1.9/3.3 KV AC



POLYCAB BS 6724 SC AWA LSZH - Power Cable, 1.9/3.3 KV AC



POLYCAB BS 6724 MC SWA LSZH - Power Cable, 1.9/3.3 KV AC



POLYCAB BS 6724 MC SWA LSZH
Power Cable, 1.9/3.3 KV AC

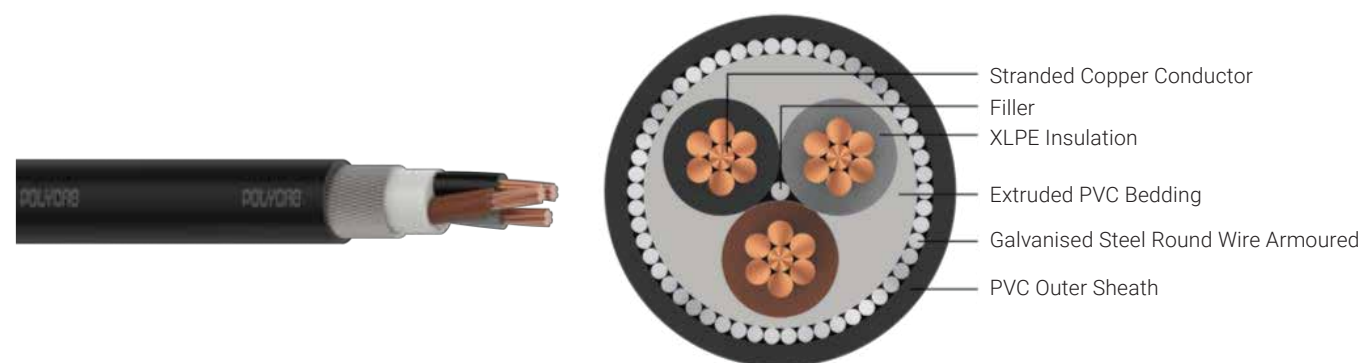

Application

POLYCAB BS 6724 MC SWA LSZH stranded copper conductor thermosetting material insulated multicore Galvanised steel round wire armoured cable is designed to use for fixed installation in indoor and outdoor power network, underground application, industrial areas and buildings where smoke emission and toxic fumes create a potential risk when exposed to fire.

Voltage Rating

1900/3300 V

Operation Temperature

Maximum operating: +90° C
Short circuit temperature 250° C

Construction

- Annealed stranded copper conductor as per IEC 60228, class 2
- Insulated with type GP8 (XLPE) to BS 7655-1.3 or type GP 6 to BS 7655-1.2 or type EI 5 to BS EN 50363-5.
- Bedding shall be extruded layer of polymeric material
- Armoured with Galvanised steel round wire
- Sheathed with LSZH polymeric material LTS1 to BS 7655-6.1

Core Identification

Brown, Black & Grey

Bending Radius:

Fixed installation – 12 x Overall Diameter

Standard and References:

- IEC 60228
- BS 7655-1.3/1.2/EN 50363-5
- BS 7655-6.1
- BS 6724-1997+A3:2008
- EN 60332-1-2

Test Voltage

11250 V AC at (20±5) °C

Compliance

- Conductor Resistance test IEC 60228
- Insulation Resistance test BS 6724
- Spark test EN 62230 & BS 5099
- Smoke emission test BS EN 61034-2
- Flame propagation test BS EN 60332-1-2

Approval

The Cable approved for BASEC, A British approval service for cables.

The cable compliant with European Regulation EN 50575, the construction Products Regulation (CPR).



POLYCAB BS 6724 MC SWA LSZH
Power Cable, 1.9/3.3 KV AC

Product Code	Nominal Cores sectional Area mm ²	Nominal insulation Thickness mm	Minimum thickness of outer sheath	Overall Diameter (Approx.) mm	Weight (Approx.) kg/km	POLYCAB/DOWEL Gland Size
MVBS10CXSWL003C010S	10	2	1.24	24.71	1351	DBW-04A/DBF-04A
MVBS10CXSWL003C016S	16	2	1.24	26.94	1652	DBW-05A/DBF-05A
MVBS10CXSWL003C025S	25	2	1.24	29.74	2104	DBW-05A/DBF-05A
MVBS10CXSWL003C035S	35	2	1.32	32.32	2540	DBW-06A/DBF-06A

- DBW – Weatherproof series
- DBF – Flame proof series

Electrical characteristics

Current carrying capacity and maximum DC conductor resistance.

Nominal cross sectional area mm ²	Reference Method C (clipped direct)	Reference Method E (in free air or on a perforated cable tray etc, horizontal or vertical)	Reference Method D (direct in ground or in ducting in ground, in or around buildings)	Maximum DC conductor resistance at 20° C Ω/km
	1 three-or 1 four-core cable, three-phase a.c. Amp.	1 three-or 1 four-core cable, three-phase a.c. Amp.	1 three-or 1 four-core cable, three-phase a.c. Amp.	
10	73	78	58	1.83
16	94	99	75	1.15
25	124	131	96.0	727
35	154	162	115	0.529

Ambient temperature: 30° C,

Conductor operating temperature: 90° C

Where cables in this table are connected to equipment or accessories designed to operate at a temperature not exceeding 70° C, the current ratings given in the equivalent table for 70° C thermoplastic insulated cables (Table 4D4A) must be used.

The above table is in accordance with Table 4E4A of BS 7671:2018

De-Rating Factor

De-rating factor for 90° C thermosetting insulated cable

Ambient temperature	35° C to 50° C	55° C	60° C	65° C	70° C
De-Rating factor	1	0.96	0.83	0.67	0.47



POLYCAB BS 6724 MC SWA LSZH (SHAPED CONDUCTOR)
Power Cable, 1.9/3.3 KV AC



Application

POLYCAB BS 6724 MC SWA LSZH stranded copper conductor thermosetting material insulated multicore Galvanised steel round wire armoured cable is designed to use for fixed installation in indoor and outdoor power network, underground application, industrial areas and buildings where smoke emission and toxic fumes create a potential risk when exposed to fire.

Voltage Rating

1900/3300 V

Operation Temperature

Maximum operating: +90° C
 Short circuit temperature 250° C

Construction

- Annealed stranded compacted copper conductor as per IEC 60228, class 2
- Insulated with type GP8 (XLPE) to BS 7655-1.3 or type GP 6 to BS 7655-1.2 or type EI 5 to BS EN 50363-5.
- Bedding shall be extruded layer of polymeric material
- Armoured with Galvanised steel round wire
- Sheathed with LSZH polymeric material LTS1 to BS 7655-6.1

Core Identification

Brown, Black & Grey

Bending Radius: 12D

Fixed installation – 12 x Overall Diameter

Standard and References

IEC 60228
 BS 7655-1.3/1.2/EN 50363-5
 BS 7655-6.1
 BS 6724-1997+A3:2008
 EN 60332-1-2

Test Voltage

11250 V AC at (20±5) °C

Compliance

Conductor Resistance test IEC 60228
 Insulation Resistance test BS 6724
 Spark test EN 62230 & BS 5099
 Smoke emission test BS EN 61034-2
 Flame propagation test BS EN 60332-1-2

Approval

The Cable approved for BASEC, A British approval service for cables.

The cable compliant with European Regulation EN 50575, the construction Products Regulation (CPR).



POLYCAB BS 6724 MC SWA LSZH (SHAPED CONDUCTOR)
Power Cable, 1.9/3.3 KV AC

Product Code	Nominal Cores sectional Area mm ²	Nominal insulation Thickness mm	Minimum thickness of outer sheath mm	Overall Diameter (Approx.) mm	Weight (Approx.) kg/km	POLYCAB/DOWEL Gland Size
MVBS10CXSWL003C035S	35	2	1.32	28.54	2093	DBW - 05A/DBF - 05A
MVBS10CXSWL003C050S	50	2	1.4	32.39	2916	DBW - 06A/DBF - 06A
MVBS10CXSWL003C070S	70	2	1.48	35.25	3814	DBW - 07/DBF - 07
MVBS10CXSWL003C095S	95	2	1.56	38.26	4706	DBW - 08/DBF - 08
MVBS10CXSWL003C120S	120	2	1.64	42.10	6028	DBW - 09/DBF - 09
MVBS10CXSWL003C150S	150	2	1.72	44.89	7151	DBW - 09/DBF - 09
MVBS10CXSWL003C185S	185	2	1.8	47.88	8591	DBW - 010A/DBF - 010A
MVBS10CXSWL003C240S	240	2	1.88	52.28	10566	DBW - 011A/DBF - 011A
MVBS10CXSWL003C300S	300	2	1.96	56.26	12702	DBW - 011/DBF - 011
MVBS10CXSWL003C400S	400	2	2.12	60.80	15292	DBW - 011/DBF - 011

- DBW – Weatherproof series
- DBF – Flame proof series

Electrical characteristics

Current carrying capacity and maximum DC conductor resistance.

Nominal cross sectional area mm ²	Reference Method C (clipped direct)		Reference Method E (in free air or on a perforated cable tray etc, horizontal or vertical)		Reference Method D (direct in ground or in ducting in ground, in or around buildings)		Maximum DC conductor resistance at 20°C Ω/km
	1 two-core cable single-phase a.c. or d.c. Amp.	1 three-or 1 four-core cable, three-phase a.c. Amp.	1 two-core cable single-phase a.c. or d.c. Amp.	1 three-or 1 four-core cable, three-phase a.c. Amp.	1 two-core cable single-phase a.c. or d.c. Amp.	1 three-or 1 four-core cable, three-phase a.c. Amp.	
35	180	154	188	162	139	115	0.529
50	219	187	228	197	164	135	0.387
70	279	238	291	251	203	167	0.268
95	338	289	354	304	239	197	0.193
120	392	335	410	353	271	223	0.153
150	451	386	472	406	306	251	0.124
185	515	441	539	463	343	281	0.0991
240	607	520	636	546	395	324	0.0754
300	698	599	732	628	446	365	0.0601
400	787	673	847	728	–	–	0.047

Ambient temperature: 30°C, Conductor operating temperature: 90°C

Where cables in this table are connected to equipment or accessories designed to operate at a temperature not exceeding 70°C, the current ratings given in the equivalent table for 70°C thermoplastic insulated cables (Table 4D3A) must be used.

The above table is in accordance with Table 4E3A of BS 7671:2018

De-Rating Factor

De-rating factor for 90°C thermosetting insulated cable

Ambient temperature	35°C to 50°C	55°C	60°C	65°C	70°C
De-Rating factor	1	0.96	0.83	0.67	0.47



POLYCAB BS 6724 SC AWA LSZH
Power Cable, 1.9/3.3 KV AC



Application

POLYCAB BS 6724 SC AWA LSZH stranded copper conductor thermosetting material insulated single core Aluminium armoured cable is designed to use for fixed installation in indoor and outdoor power network, underground application, industrial areas and buildings where smoke emission and toxic fumes create a potential risk when exposed to fire.

Voltage Rating

1900/3300 V

Operation Temperature

Maximum operating: +90° C
Short circuit temperature 250° C

Construction

- Annealed stranded copper conductor as per IEC 60228, class 2
- Insulated with cross linked type GP8 to BS 7655-1.3 or type GP 6 to BS 7655-1.2 or type EI-5 to BS EN 50363-5.
- Bedding shall be extruded layer of polymeric material
- Armoured with Aluminium round wire
- Sheathed with LSZH polymeric material LTS1 to BS 7655-6.1

Core Identification

Brown or Blue

Bending Radius: 12D

Fixed installation – 12 x Overall Diameter

Standard and References

IEC 60228
BS 7655-1.3/1.2/EN 50363-5
BS 7655-6.1
BS 6724-1997+A3:2008
EN 60332-1-2

Test Voltage

11250 V AC at (20±5) °C

Compliance

Conductor Resistance test IEC 60228
Insulation Resistance test BS 6724
Spark test EN 62230 & BS 5099
Smoke emission test BS EN 61034-2
Flame propagation test BS EN 60332-1-2

Approval

The Cable approved for BASEC, A British approval service for cables.

The cable compliant with European Regulation EN 50575, the construction Products Regulation (CPR).



POLYCAB BS 6724 SC AWA LSZH
Power Cable, 1.9/3.3 KV AC

Product Code	Nominal Cores sectional Area mm ²	Nominal insulation Thickness mm	Minimum thickness of outer sheath mm	Overall Diameter (Approx.) mm	Weight (Approx.) kg/km	POLYCAB/DOWEL Gland Size
MVBS10CXSWL001C050S	50	2	1.08	19.35	885	DBW-02A/DBF-02A
MVBS10CXSWL001C075S	75	2	1.08	20.99	1128	DBW-03/DBF-03
MVBS10CXSWL001C095S	95	2	1.08	22.78	1425	DBW-03/DBF-03
MVBS10CXSWL001C120S	120	2	1.16	25.60	1814	DBW-04A/DBF-04A
MVBS10CXSWL001C150S	150	2	1.16	27.26	2162	DBW-05A/DBF-05A
MVBS10CXSWL001C185S	185	2	1.24	29.15	2580	DBW-05A/DBF-05A
MVBS10CXSWL001C240S	240	2	1.24	31.58	3198	DBW-06A/DBF-06A
MVBS10CXSWL001C300S	300	2	1.32	34.10	3889	DBW-07/DBF-07
MVBS10CXSWL001C400S	400	2	1.4	38.84	5139	DBW-08/DBF-08
MVBS10CXSWL001C500S	500	2.2	1.48	42.52	6322	DBW-09/DBF-09
MVBS10CXSWL001C630S	630	2.4	1.56	46.62	7824	DBW-010A/DBF-010A

- DBW – Weatherproof series
- DBF – Flame proof series

Electrical characteristics

Current carrying capacity and maximum DC conductor resistance.

Nominal cross sectional area mm ²	Reference Method C (clipped direct) Touching		Reference Method F (in free air or on a perforated cable tray, horizontal or vertical)									Maximum DC conductor resistance at 20°C Ω/km
	2 cables, single-phase a.c. or d.c. flat Amp.	3 or 4 cables, three-phase a.c. flat Amp.	Touching			Spaced by one cable diameter						
			2 cables, single-phase a.c. or d.c. flat Amp.	3 cables, three-phase a.c. or d.c. flat Amp.	3 cables, three-phase a.c. or d.c. trefoil Amp.	2 cables, d.c.		2 cables, single-phase a.c.		3 or 4 cables, three-phase a.c.		
50	237	220	253	232	222	284	270	282	266	288	266	0.387
70	303	277	322	293	285	356	349	357	337	358	331	0.268
95	367	333	389	352	346	446	426	436	412	425	393	0.193
120	425	383	449	405	402	519	497	504	477	485	449	0.153
150	488	437	516	462	463	600	575	566	539	549	510	0.124
185	557	496	587	524	529	688	660	643	614	618	574	0.0991
240	656	579	689	612	625	815	782	749	714	715	666	0.0754
300	755	662	792	700	720	943	906	842	805	810	755	0.0601
400	853	717	899	767	815	1,137	1,094	929	889	848	797	0.047
500	962	791	1,016	851	918	1,314	1,266	1,032	989	923	871	0.0366
630	1,082	861	1,146	935	1,027	1,528	1,474	1,139	1,092	992	940	0.0283

Ambient temperature: 30°C, Conductor operating temperature: 90°C

Where cables in this table are connected to equipment or accessories designed to operate at a temperature not exceeding 70°C, the current ratings given in the equivalent table for 70°C thermoplastic insulated cables (Table 4D3A) must be used.

The above table is in accordance with Table 4E3A of BS 7671:2018

De-Rating Factor

De-rating factor for 90°C thermosetting insulated cable

Ambient temperature	35°C to 50°C	55°C	60°C	65°C	70°C
De-Rating factor	1	0.96	0.83	0.67	0.47



Polycab XLPE Insulated Round Wire Armoured LSZH Medium Voltage Cable conforming to BS 7835



These include medium voltage armoured cable generally conforming the construction and performance of voltage grade 3.8/6.6 (7.2) kV, 6.35/11 (12) kV, 8.7/15(17.5) kV, 12.7/22 (24) kV and 19/33 (36) kV as per BS 7835. These cables are specially designed for low smoke & low halogen emissions and are suitable for use in power networks, underground and in cable ducts.

These cables are available in single and three core with maximum operating conductor temperature of 90°C and maximum short circuit conductor temperature 250°C.

Conductor: The high conductivity stranded compacted aluminium or copper conductor is produced in-house with highly advanced machines.

Screen: Semi-conducting compound.

Insulation: High insulation resistance cross-linked polyethylene or EPR insulation.

Screen: Insulation screened by semi-conducting compound followed by copper tape.

Inner covering: It's an extruded low smoke zero halogen compound and is placed between insulation screen and armour.

Armour: Made of steel or aluminium wire, the armour helps the cable to withstand mechanical & electrical stresses.

Sheath: Developed in-house, the LSZH compound sheath can withstand mechanical abrasion and weather.

The manufacturing process at Polycab follows stringent quality control principles, with additional testing at every stage. This ensures that only the highest quality product rolls out of the factory.

The construction based on the application and requirement of the user against BS 7835.



POLYCAB MV CU BS 7835 3.8/6.6 KV - Medium Voltage Armoured Cable, 3.8/6.6 (7.2) KV AC



POLYCAB MV CU BS 7835 6.35/11 KV - Medium Voltage Armoured Cable, 6.35/11 (12) KV AC



POLYCAB MV CU BS 7835 8.7/15 KV - Medium Voltage Armoured Cable, 8.7/15 (17.5) KV AC



POLYCAB MV CU BS 7835 12.7/22 KV - Medium Voltage Armoured Cable, 12.7/22 (24) KV AC



POLYCAB MV CU BS 7835 19/33 KV - Medium Voltage Armoured Cable, 19/33 (36) KV AC



POLYCAB MV AL BS 7835 3.8/6.6 KV - Medium Voltage Armoured Cable, 3.8/6.6 (7.2) KV AC



POLYCAB MV AL BS 7835 6.35/11 KV - Medium Voltage Armoured Cable, 6.35/11 (12) KV AC



POLYCAB MV AL BS 7835 8.7/15 KV - Medium Voltage Armoured Cable, 8.7/15 (17.5) KV AC



POLYCAB MV AL BS 7835 12.7/22 KV - Medium Voltage Armoured Cable, 12.7/22 (24) KV AC



POLYCAB MV AL BS 7835 19/33 KV - Medium Voltage Armoured Cable, 19/33 (36) KV AC



POLYCAB MV AL BS 7835 8.7/15 KV
Medium Voltage Armoured Cable, 8.7/15 (17.5) KV AC

Single Core



Three Core



Outstanding Features

- Flame retardant
- High life
- UV resistant
- Oil resistant
- Low smoke emission

Application

POLYCAB MV AL BS 7835 8.7/15 KV XLPE insulated with aluminium conductor single & multi core cable is designed for low smoke & low halogen evolution and this suitable to use for power networks, underground and in cable ducting.

Voltage Rating

Nominal Voltage: 8.7/15 (17.5) kV

Operation Temperature

Max. operating temperature: +90°C
Max. Short Circuit Temperature: 250°C

Construction

- Conductor: Circular Compacted aluminium conductor as per BS EN/IEC 60228, class 2
- Conductor Screen: Extruded Semi-conductive compound
- Insulation: XLPE as per BS 7655-1.3 or EPR as per BS 7655-1.2
- Non-Metallic Insulation Screen: Extruded Semi-conductive compound
- Metallic Insulation Screen: Copper tape screen
- Inner Covering: Extruded LSZH (Low Smoke Zero Halogen) compound
- Armour:
 - Single Core: Aluminium Round Wire Armoured (AWA)
 - Multi Core: Galvanised Steel Round Wire Armoured (SWA)
- Outer Sheath: Extruded LSZH compound as per BS 7655-6.1, Colour: Black

Standard and References:

BS EN/IEC 60228
BS 7655-1.3/1.2
BS 7655-6.1
BS 7835

Test Voltage

35kV AC

Impulse Test Voltage

Peak 112kV AC

Compliance

- Conductor resistance BS EN/IEC 60228
- Insulation resistance BS 7835
- Flame Retardant test BS EN/IEC 60332-1-2
- Partial Discharge test BS 7835
- Smoke Emission test BS EN/IEC 61034-2

Approval



Bending Radius:

Single core cable
Fixed Installation: 15 x Overall diameter
Three core cable
Fixed Installation: 12 x Overall diameter



OUR CERTIFICATION
ISO 9001 | ISO 14001 | ISO 45001



POLYCAB MV AL BS 7835 8.7/15 KV
Medium Voltage Armoured Cable, 8.7/15 (17.5) KV AC

DIMENSIONAL CHARACTERISTICS:

Product Code	No. of Cores	Nominal Cross sectional Area	Nominal Diameter			Weight (Approx.)
			Under armour	Over armour	Overall	
	No.	mm ²	mm	mm	mm	Kg/Km
MVBS23AXAWLS001C070S	1	70	23.0	26.2	30.0	1100
MVBS23AXAWLS001C095S	1	95	24.8	28.0	32.0	1300
MVBS23AXAWLS001C120S	1	120	26.4	30.4	34.0	1500
MVBS23AXAWLS001C150S	1	150	28.5	32.5	37.0	1700
MVBS23AXAWLS001C185S	1	185	30.2	34.2	38.0	1900
MVBS23AXAWLS001C240S	1	240	32.6	36.6	41.0	2200
MVBS23AXAWLS001C300S	1	300	35.1	39.1	44.0	2500
MVBS23AXAWLS001C400S	1	400	38.3	43.3	48.0	3100
MVBS23AXAWLS001C500S	1	500	42.0	47.0	52.0	3650
MVBS23AXAWLS001C630S	1	630	45.4	50.4	56.0	4200
MVBS23AXAWLS001C800S	1	800	49.5	54.5	60.0	4950
MVBS23AXAWLS001C01KS	1	1000	54.2	59.2	65.0	5850
MVBS23AXSWLS003C070S	3	70	48.8	53.8	59.0	5400
MVBS23AXSWLS003C095S	3	95	52.6	57.6	64.0	6150
MVBS23AXSWLS003C120S	3	120	56.0	61.0	67.0	6750
MVBS23AXSWLS003C150S	3	150	59.7	64.7	71.0	7500
MVBS23AXSWLS003C185S	3	185	63.3	69.6	76.0	9050
MVBS23AXSWLS003C240S	3	240	69.1	75.4	82.0	10400
MVBS23AXSWLS003C300S	3	300	74.4	80.7	88.0	11750
MVBS23AXSWLS003C400S	3	400	81.4	87.7	96.0	13700
MVBS23AXSWLS003C500S	3	500	88.9	95.2	103.0	15800
MVBS23AXSWLS003C630S	3	630	96.1	102.4	111.0	18000



OUR CERTIFICATION
ISO 9001 | ISO 14001 | ISO 45001



ELECTRICAL CHARACTERISTICS:

No. of Core	Nominal Cross sectional Area	Max. DC Resistance at 20°C	Max. AC Resistance at 90°C	Short circuit current rating	Capacitance Approx.	Inductance Approx.	Reactance Approx.
No.	mm ²	Ω/km	Ω/km	kA/s	μF/km	mH/km	Ω/km
1	70	0.443	0.568	6.61	0.22	0.40	0.13
1	95	0.320	0.411	8.98	0.24	0.38	0.12
1	120	0.253	0.325	11.34	0.27	0.37	0.12
1	150	0.206	0.265	14.17	0.29	0.36	0.11
1	185	0.164	0.211	17.48	0.32	0.35	0.11
1	240	0.125	0.161	22.68	0.35	0.33	0.10
1	300	0.100	0.129	28.35	0.39	0.32	0.10
1	400	0.0778	0.101	37.79	0.44	0.32	0.10
1	500	0.0605	0.080	47.24	0.522	0.256	0.080
1	630	0.0469	0.063	59.52	0.574	0.247	0.078
1	800	0.0367	0.051	75.59	0.638	0.239	0.075
1	1000	0.0291	0.042	94.48	0.704	0.232	0.073

No. of Cores	Nominal Cross sectional Area	Max. DC Resistance at 20°C	Max. AC Resistance at 90°C	Short circuit current rating	Capacitance Approx.	Inductance Approx.	Reactance Approx.
No.	mm ²	Ω/km	Ω/km	kA/s	μF/km	mH/km	Ω/km
3	70	0.443	0.568	6.61	0.22	0.34	0.11
3	95	0.320	0.411	8.98	0.24	0.32	0.10
3	120	0.253	0.325	11.34	0.27	0.31	0.10
3	150	0.206	0.265	14.17	0.29	0.30	0.09
3	185	0.164	0.211	17.48	0.32	0.29	0.09
3	240	0.125	0.161	22.68	0.35	0.28	0.09
3	300	0.100	0.129	28.35	0.39	0.27	0.09
3	400	0.0778	0.101	37.79	0.44	0.26	0.08
3	500	0.0605	0.080	47.24	0.48	0.256	0.080
3	630	0.0469	0.063	59.52	0.53	0.250	0.079

CURRENT CARRYING CAPACITY:

No. of core	Nominal Cross sectional area	Continuous Current Rating					
		Buried direct in the ground		In single-way ducts		In air	
		Trefoil Amp.	Flat spaced Amp.	Trefoil ducts Amp.	Flat touching Amp.	Trefoil Amp.	Flat touching Amp.
No.	mm ²						
1	70	186	192	176	178	230	236
1	95	221	229	210	213	280	287
1	120	252	260	240	242	324	332
1	150	281	288	267	271	368	376
1	185	317	324	303	307	424	432
1	240	367	373	351	356	502	511
1	300	414	419	397	402	577	586
1	400	470	466	451	457	673	676
1	500	498	471	433	389	748	712
1	630	555	514	481	421	856	798
1	800	597	536	514	436	949	859
1	1000	643	565	550	457	1049	931

No. of core	Nominal Cross sectional area	Continuous current capacity		
		In ground at 20°C Amp.	In a buried duct Amp.	In air Amp.
No.	mm ²			
3	70	171	150	196
3	95	204	180	238
3	120	232	206	274
3	150	259	231	309
3	185	293	262	354
3	240	338	304	415
3	300	380	343	472
3	400	432	393	545
3	500	494	435	649

Maximum conductor temperature 90°C
 Ambient air temperature 30°C
 Ground temperature 20°C
 Depth of laying 0.8 m
 Thermal resistivity of soil 1.5 K.m/W
 Thermal resistivity of earthenware ducts 1.2 K.m/W

Current rating de-rating factors for other than 30°C ambient air temperature.

Air Temperature	20	25	35	40	45	50	55	60
De-rating factor	1.08	1.04	0.96	0.91	0.87	0.82	0.76	0.71

Current rating de-rating factors for other than 20°C ground temperature.

Ground Temperature	10	15	25	30	35	40	45	50
De-rating factor	1.07	1.04	0.96	0.93	0.89	0.85	0.8	0.76



OUR CERTIFICATION
 ISO 9001 | ISO 14001 | ISO 45001



OUR CERTIFICATION
 ISO 9001 | ISO 14001 | ISO 45001



POLYCAB MV AL BS 7835 3.8/6.6 KV
Medium Voltage Armoured Cable, 3.8/6.6 (7.2) KV AC

Single Core



Three Core



Outstanding Features

- Flame retardant
- High life
- UV resistant
- Oil resistant
- Low smoke emission

Application

POLYCAB MV AL BS 7835 3.8/6.6 KV XLPE insulated with aluminium conductor single & multi core cable is designed for low smoke & low halogen evolution and this suitable to use for power distribution for external and direct burial applications in power network system.

Voltage Rating

Nominal Voltage: 3.8/6.6 (7.2) kV

Operation Temperature

Max. operating temperature: +90°C
Max. Short Circuit Temperature: 250°C

Construction

- Conductor: Circular Compacted Aluminium conductor as per BS EN/IEC 60228, class 2
- Conductor Screen: Extruded Semi-conductive compound
- Insulation: XLPE as per BS 7655 – 1.3 or EPR as per BS 7655-1.2
- Non-Metallic Insulation Screen: Extruded Semi-conductive compound
- Metallic Insulation Screen: Copper tape screen
- Inner Covering: Extruded LSZH (Low Smoke Zero Halogen) compound
- Armour:
 - Single Core: Aluminium Round Wire Armoured (AWA)
 - Multi Core: Galvanised Steel Round Wire Armoured (SWA)
- Outer Sheath: Extruded LSZH compound as per BS 7655-6.1, Colour: Black

Standard and References:

BS EN/IEC 60228
BS 7655-1.3/1.2
BS 7655-6.1
BS 7835

Test Voltage

15kV AC

Impulse Test Voltage

Peak 75kV AC

Compliance

- Conductor resistance IEC 60228
- Insulation resistance BS 7835
- Flame Retardant test BS EN/IEC 60332-1-2
- Partial Discharge test BS 7835
- Smoke Emission test BS EN/IEC 61034-2

Approval



Bending Radius:

Single core cable
Fixed Installation: 15 x Overall diameter
Three core cable
Fixed Installation: 12 x Overall diameter

POLYCAB MV AL BS 7835 3.8/6.6 KV
Medium Voltage Armoured Cable, 3.8/6.6 (7.2) KV AC

DIMENSIONAL CHARACTERISTICS:

Product Code	No. of Cores	Nominal Cross sectional Area	Nominal Diameter			Weight (Approx.)
			Under armour	Over armour	Overall	
	No.	mm ²	mm	mm	mm	Kg/Km
MVBS21AXAWLS001C070S	1	70	19.00	22.20	26.0	900
MVBS21AXAWLS001C095S	1	95	20.80	24.00	28.0	1000
MVBS21AXAWLS001C120S	1	120	22.40	25.60	29.5	1150
MVBS21AXAWLS001C150S	1	150	24.10	27.30	31.5	1300
MVBS21AXAWLS001C185S	1	185	25.80	29.00	33.0	1500
MVBS21AXAWLS001C240S	1	240	28.80	32.80	37.0	1900
MVBS21AXAWLS001C300S	1	300	31.70	35.70	40.5	2200
MVBS21AXAWLS001C400S	1	400	35.30	39.30	44.0	2650
MVBS21AXAWLS001C500S	1	500	39.00	44.00	49.0	3300
MVBS21AXAWLS001C630S	1	630	42.90	47.90	53.0	3900
MVBS21AXAWLS001C800S	1	800	46.90	51.90	57.5	4650
MVBS21AXAWLS001C01KS	1	1000	51.60	56.60	62.5	5500
MVBS21AXSWLS003C070S	3	70	39.70	44.70	50.0	4100
MVBS21AXSWLS003C095S	3	95	43.60	48.60	54.0	4750
MVBS21AXSWLS003C120S	3	120	46.90	51.90	58.0	5350
MVBS21AXSWLS003C150S	3	150	51.10	56.10	62.0	6100
MVBS21AXSWLS003C185S	3	185	54.70	59.70	66.0	6800
MVBS21AXSWLS003C240S	3	240	60.40	65.40	72.0	8000
MVBS21AXSWLS003C300S	3	300	67.10	73.40	80.0	10300
MVBS21AXSWLS003C400S	3	400	74.90	81.20	89.0	12250
MVBS21AXSWLS003C500S	3	500	82.00	88.30	96.0	14200
MVBS21AXSWLS003C630S	3	630	89.90	96.20	104.0	16600



ELECTRICAL CHARACTERISTICS:

No. of Core	Nominal Cross sectional Area	Max. DC Resistance at 20°C	Max. AC Resistance at 90°C	Short circuit current rating	Capacitance Approx.	Inductance Approx.	Reactance Approx.
No.	mm ²	Ω/km	Ω/km	kA/s	μF/km	mH/km	Ω/km
1	70	0.443	0.568	6.61	0.33	0.37	0.12
1	95	0.320	0.411	8.98	0.38	0.35	0.11
1	120	0.253	0.325	11.34	0.41	0.34	0.11
1	150	0.206	0.265	14.17	0.46	0.33	0.10
1	185	0.164	0.211	17.48	0.50	0.32	0.10
1	240	0.125	0.161	22.68	0.54	0.31	0.10
1	300	0.100	0.129	28.35	0.57	0.31	0.10
1	400	0.0778	0.101	37.79	0.61	0.30	0.09
1	500	0.0605	0.080	47.24	0.708	0.24	0.08
1	630	0.0469	0.063	59.52	0.784	0.24	0.07
1	800	0.0367	0.051	75.59	0.870	0.23	0.07
1	1000	0.0291	0.042	94.48	0.963	0.22	0.07

No. of Cores	Nominal Cross sectional Area	Max. DC Resistance at 20°C	Max. AC Resistance at 90°C	Short circuit current rating	Capacitance Approx.	Inductance Approx.	Reactance Approx.
No.	mm ²	Ω/km	Ω/km	kA/s	μF/km	mH/km	Ω/km
3	70	0.443	0.568	6.61	0.33	0.30	0.092
3	95	0.320	0.411	8.98	0.38	0.29	0.088
3	120	0.253	0.325	11.34	0.41	0.28	0.085
3	150	0.206	0.265	14.17	0.46	0.27	0.083
3	185	0.164	0.211	17.48	0.50	0.26	0.081
3	240	0.125	0.161	22.68	0.54	0.26	0.079
3	300	0.100	0.129	28.35	0.57	0.25	0.078
3	400	0.0778	0.101	37.79	0.61	0.25	0.077
3	500	0.0605	0.080	47.24	0.68	0.25	0.075
3	630	0.0469	0.063	59.52	0.75	0.25	0.074

CURRENT CARRYING CAPACITY:

No. of core	Nominal Cross sectional area	Continuous Current Rating					
		Buried direct in the ground		In single-way ducts		In air	
		Trefoil Amp.	Flat spaced Amp.	Trefoil ducts Amp.	Flat touching Amp.	Trefoil Amp.	Flat touching Amp.
No.	mm ²						
1	70	186	192	176	178	230	236
1	95	221	229	210	213	280	287
1	120	252	260	240	242	324	332
1	150	281	288	267	271	368	376
1	185	317	324	303	307	424	432
1	240	367	373	351	356	502	511
1	300	414	419	397	402	577	586
1	400	470	466	451	457	673	676
1	500	498	471	433	389	748	712
1	630	555	513	481	421	855	798
1	800	596	535	514	435	949	858
1	1000	643	565	550	457	1049	931

No. of core	Nominal Cross sectional area	Continuous current capacity		
		In ground at 20°C Amp.	In a buried duct Amp.	In air Amp.
No.	mm ²			
3	70	171	150	196
3	95	204	180	238
3	120	232	206	274
3	150	259	231	309
3	185	293	262	354
3	240	338	304	415
3	300	380	343	472
3	400	432	393	545
3	500	494	435	649

Maximum conductor temperature 90°C
 Ambient air temperature 30°C
 Ground temperature 20°C
 Depth of laying 0.8 m
 Thermal resistivity of soil 1.5 K.m/W
 Thermal resistivity of earthenware ducts 1.2 K.m/W

Current rating de-rating factors for other than 30°C ambient air temperature.

Air Temperature	20	25	35	40	45	50	55	60
De-rating factor	1.08	1.04	0.96	0.91	0.87	0.82	0.76	0.71

Current rating de-rating factors for other than 20°C ground temperature.

Ground Temperature	10	15	25	30	35	40	45	50
De-rating factor	1.07	1.04	0.96	0.93	0.89	0.85	0.8	0.76



OUR CERTIFICATION
ISO 9001 | ISO 14001 | ISO 45001



OUR CERTIFICATION
ISO 9001 | ISO 14001 | ISO 45001



POLYCAB MV AL BS 7835 6.35/11 KV
Medium Voltage Armoured Cable, 6.35/11 (12) KV AC

Single Core



Three Core



Outstanding Features

- Flame retardant
- High life
- UV resistant
- Oil resistant
- Low smoke emission

Application

POLYCAB MV AL BS 7835 6.35/11 KV XLPE insulated with aluminium conductor single & multi core cable is designed for low smoke & low halogen evolution and this suitable to use for power networks, underground and in cable ducting.

Voltage Rating

Nominal Voltage: 6.35/11 (12) kV

Operation Temperature

Max. operating temperature: +90°C
Max. Short Circuit Temperature: 250°C

Construction

- Conductor: Circular Compacted Aluminium conductor as per BS EN/IEC 60228, class 2
- Conductor Screen: Extruded Semi-conductive compound
- Insulation: XLPE as per BS 7655-1.3 or EPR as per BS 7655-1.2
- Non-Metallic Insulation Screen: Extruded Semi-conductive compound
- Metallic Insulation Screen: Copper tape screen
- Inner Covering: Extruded LSZH (Low Smoke Zero Halogen) compound
- Armour:
 - Single Core: Aluminium Round Wire Armoured (AWA)
 - Multi Core: Galvanised Steel Round Wire Armoured (SWA)
- Outer Sheath: Extruded LSZH compound as per BS 7655-6.1, Colour: Black

Standard and References:

BS EN/IEC 60228
BS 7655-1.3/1.2
BS 7655-6.1
BS 7835

Test Voltage

25.5kV AC

Impulse Test Voltage

Peak 95kV AC

Compliance

- Conductor resistance BS EN/IEC 60228
- Insulation resistance BS 7835
- Flame Retardant test BS EN/IEC 60332-1-2
- Partial Discharge test BS 7835
- Smoke Emission test BS EN/IEC 61034-2

Approval



Bending Radius:

Single core cable
Fixed Installation: 15 x Overall diameter
Three core cable
Fixed Installation: 12 x Overall diameter

POLYCAB MV AL BS 7835 6.35/11 KV
Medium Voltage Armoured Cable, 6.35/11 (12) KV AC

DIMENSIONAL CHARACTERISTICS:

Product Code	No. of Cores	Nominal Cross sectional Area	Nominal Diameter			Weight (Approx.)
			Under armour	Over armour	Overall	
	No.	mm ²	mm	mm	mm	Kg/Km
MVBS22AXAWLS001C070S	1	70	20.8	24.0	28.0	950
MVBS22AXAWLS001C095S	1	95	22.6	25.8	30.0	1150
MVBS22AXAWLS001C120S	1	120	24.2	27.4	31.0	1250
MVBS22AXAWLS001C150S	1	150	25.9	29.1	33.0	1450
MVBS22AXAWLS001C185S	1	185	28.0	32.0	36.0	1750
MVBS22AXAWLS001C240S	1	240	30.4	34.4	39.0	2000
MVBS22AXAWLS001C300S	1	300	32.9	36.9	41.0	2300
MVBS22AXAWLS001C400S	1	400	36.1	40.1	45.0	2750
MVBS22AXAWLS001C500S	1	500	39.4	44.4	49.0	3350
MVBS22AXAWLS001C630S	1	630	43.2	48.2	53.0	4000
MVBS22AXAWLS001C800S	1	800	47.3	52.3	58.0	4700
MVBS22AXAWLS001C01KS	1	1000	52.0	57.0	63.0	5550
MVBS22AXSWLS003C070S	3	70	43.6	48.6	54.0	4650
MVBS22AXSWLS003C095S	3	95	47.5	52.5	58.0	5300
MVBS22AXSWLS003C120S	3	120	51.2	56.2	62.0	6000
MVBS22AXSWLS003C150S	3	150	55.0	60.0	66.0	6700
MVBS22AXSWLS003C185S	3	185	58.6	63.6	70.0	7400
MVBS22AXSWLS003C240S	3	240	63.9	70.2	77.0	9400
MVBS22AXSWLS003C300S	3	300	69.7	76.0	83.0	10800
MVBS22AXSWLS003C400S	3	400	76.6	82.9	90.0	12600
MVBS22AXSWLS003C500S	3	500	83.7	90.0	98.0	14600
MVBS22AXSWLS003C630S	3	630	91.4	97.7	106.0	16900



ELECTRICAL CHARACTERISTICS:

No. of Core	Nominal Cross sectional Area	Max. DC Resistance at 20°C	Max. AC Resistance at 90°C	Short circuit current rating	Capacitance Approx.	Inductance Approx.	Reactance Approx.
No.	mm ²	Ω/km	Ω/km	kA/s	μF/km	mH/km	Ω/km
1	70	0.443	0.568	6.61	0.26	0.38	0.12
1	95	0.320	0.411	8.98	0.30	0.37	0.12
1	120	0.253	0.325	11.34	0.33	0.35	0.11
1	150	0.206	0.265	14.17	0.36	0.34	0.11
1	185	0.164	0.211	17.48	0.39	0.34	0.11
1	240	0.125	0.161	22.68	0.44	0.32	0.10
1	300	0.100	0.129	28.35	0.49	0.31	0.10
1	400	0.0778	0.101	37.79	0.55	0.30	0.09
1	500	0.0605	0.080	47.24	0.670	0.245	0.077
1	630	0.0469	0.063	59.52	0.739	0.239	0.075
1	800	0.0367	0.051	75.59	0.823	0.231	0.073
1	1000	0.0291	0.042	94.48	0.911	0.225	0.071

No. of Cores	Nominal Cross sectional Area	Max. DC Resistance at 20°C	Max. AC Resistance at 90°C	Short circuit current rating	Capacitance Approx.	Inductance Approx.	Reactance Approx.
No.	mm ²	Ω/km	Ω/km	kA/s	μF/km	mH/km	Ω/km
3	70	0.443	0.568	6.61	0.26	0.31	0.098
3	95	0.320	0.411	8.98	0.30	0.30	0.094
3	120	0.253	0.325	11.34	0.33	0.29	0.090
3	150	0.206	0.265	14.17	0.36	0.28	0.088
3	185	0.164	0.211	17.48	0.39	0.27	0.086
3	240	0.125	0.161	22.68	0.44	0.26	0.083
3	300	0.100	0.129	28.35	0.49	0.26	0.081
3	400	0.0778	0.101	37.79	0.55	0.25	0.078
3	500	0.0605	0.080	47.24	0.61	0.244	0.077
3	630	0.0469	0.063	59.52	0.67	0.239	0.075

CURRENT CARRYING CAPACITY:

No. of core	Nominal Cross sectional area	Continuous Current Rating					
		Buried direct in the ground		In single-way ducts		In air	
		Trefoil Amp.	Flat spaced Amp.	Trefoil ducts Amp.	Flat touching Amp.	Trefoil Amp.	Flat touching Amp.
No.	mm ²						
1	70	186	192	176	178	230	236
1	95	221	229	210	213	280	287
1	120	252	260	240	242	324	332
1	150	281	288	267	271	368	376
1	185	317	324	303	307	424	432
1	240	367	373	351	356	502	511
1	300	414	419	397	402	577	586
1	400	470	466	451	457	673	676
1	500	498	471	433	389	748	712
1	630	555	514	481	421	856	798
1	800	597	536	514	436	949	859
1	1000	643	565	550	457	1049	931

No. of core	Nominal Cross sectional area	Continuous current capacity		
		In ground at 20°C Amp.	In a buried duct Amp.	In air Amp.
No.	mm ²			
3	70	171	150	196
3	95	204	180	238
3	120	232	206	274
3	150	259	231	309
3	185	293	262	354
3	240	338	304	415
3	300	380	343	472
3	400	432	393	545
3	500	494	435	649

Maximum conductor temperature 90°C
 Ambient air temperature 30°C
 Ground temperature 20°C
 Depth of laying 0.8 m
 Thermal resistivity of soil 1.5 K.m/W
 Thermal resistivity of earthenware ducts 1.2 K.m/W

Current rating de-rating factors for other than 30°C ambient air temperature.

Air Temperature	20	25	35	40	45	50	55	60
De-rating factor	1.08	1.04	0.96	0.91	0.87	0.82	0.76	0.71

Current rating de-rating factors for other than 20°C ground temperature.

Ground Temperature	10	15	25	30	35	40	45	50
De-rating factor	1.07	1.04	0.96	0.93	0.89	0.85	0.8	0.76



OUR CERTIFICATION
ISO 9001 | ISO 14001 | ISO 45001



OUR CERTIFICATION
ISO 9001 | ISO 14001 | ISO 45001



POLYCAB MV AL BS 7835 12.7/22 KV
Medium Voltage Armoured Cable, 12.7/22 (24) KV AC

Single Core



Three Core



Outstanding Features

- Flame retardant
- High life
- UV resistant
- Oil resistant
- Low smoke emission

Application

POLYCAB MV AL BS 7835 12.7/22 KV XLPE insulated with aluminium conductor single & multi core cable is designed for low smoke & low halogen evolution and this suitable to use for power networks, underground and in cable ducting.

Voltage Rating

Nominal Voltage: 12.7/22 (24) kV

Operation Temperature

Max. operating temperature: +90°C
Max. Short Circuit Temperature: 250°C

Construction

- Conductor: Circular Compacted aluminium conductor as per BS EN/IEC 60228, class 2
- Conductor Screen: Extruded Semi-conductive compound
- Insulation: XLPE as per BS 7655-1.3 or EPR as per BS 7655-1.2
- Non-Metallic Insulation Screen: Extruded Semi-conductive compound
- Metallic Insulation Screen: Copper tape screen
- Inner Covering: Extruded LSZH (Low Smoke Zero Halogen) compound
- Armour:
 - Single Core: Aluminium Round Wire Armoured (AWA)
 - Multi Core: Galvanised Steel Round Wire Armoured (SWA)
- Outer Sheath: Extruded LSZH compound as per BS 7655-6.1, Colour: Black

Standard and References:

BS EN/IEC 60228
BS 7655-1.3/1.2
BS 7655-6.1
BS 7835

Test Voltage

51kV AC

Impulse Test Voltage

Peak 144kV AC

Compliance

- Conductor resistance BS EN/IEC 60228
- Insulation resistance BS 7835
- Flame Retardant test EN/IEC 60332-1-2
- Partial Discharge test BS 7835
- Smoke Emission test BS EN/IEC 61034-2

Approval



POLYCAB MV AL BS 7835 12.7/22 KV
Medium Voltage Armoured Cable, 12.7/22 (24) KV AC

DIMENSIONAL CHARACTERISTICS:

Product Code	No. of Cores	Nominal Cross sectional Area	Nominal Diameter			Weight (Approx.)
			Under armour	Over armour	Overall	
	No.	mm ²	mm	mm	mm	Kg/Km
MVBS19AXAWLS001C070S	1	70	25.0	28.2	32.0	1250
MVBS19AXAWLS001C095S	1	95	26.8	30.8	35.0	1500
MVBS19AXAWLS001C120S	1	120	28.8	32.8	37.0	1700
MVBS19AXAWLS001C150S	1	150	30.5	34.5	39.0	1900
MVBS19AXAWLS001C185S	1	185	32.2	36.2	41.0	2050
MVBS19AXAWLS001C240S	1	240	34.6	38.6	43.0	2350
MVBS19AXAWLS001C300S	1	300	37.1	41.1	46.0	2700
MVBS19AXAWLS001C400S	1	400	40.7	45.7	51.0	3350
MVBS19AXAWLS001C500S	1	500	44.0	49.0	54.0	3900
MVBS19AXAWLS001C630S	1	630	47.4	52.4	58.0	4450
MVBS19AXAWLS001C800S	1	800	51.9	56.9	63.0	5250
MVBS19AXAWLS001C01KS	1	1000	56.2	61.2	67.0	6150
MVBS19AXSWLS003C070S	3	70	53.1	58.1	64.0	6050
MVBS19AXSWLS003C095S	3	95	56.9	61.9	68.0	6750
MVBS19AXSWLS003C120S	3	120	60.3	65.3	72.0	7450
MVBS19AXSWLS003C150S	3	150	64.4	70.7	78.0	9200
MVBS19AXSWLS003C185S	3	185	68.0	74.3	81.0	9950
MVBS19AXSWLS003C240S	3	240	73.4	79.7	87.0	11300
MVBS19AXSWLS003C300S	3	300	78.8	85.1	93.0	12700
MVBS19AXSWLS003C400S	3	400	85.7	92.0	100.0	14600
MVBS19AXAWLS003C500S	3	500	93.2	99.5	108.0	16800
MVBS19AXAWLS003C630S	3	630	100.5	106.8	116.0	19200



ELECTRICAL CHARACTERISTICS:

No. of Core	Nominal Cross sectional Area	Max. DC Resistance at 20°C	Max. AC Resistance at 90°C	Short circuit current rating	Capacitance Approx.	Inductance Approx.	Reactance Approx.
No.	mm ²	Ω/km	Ω/km	kA/s	μF/km	mH/km	Ω/km
1	70	0.443	0.568	6.61	0.19	0.41	0.13
1	95	0.320	0.411	8.98	0.21	0.40	0.13
1	120	0.253	0.325	11.34	0.23	0.38	0.12
1	150	0.206	0.265	14.17	0.25	0.37	0.12
1	185	0.164	0.211	17.48	0.27	0.36	0.11
1	240	0.125	0.161	22.68	0.30	0.34	0.11
1	300	0.100	0.129	28.35	0.33	0.33	0.10
1	400	0.0778	0.101	37.79	0.37	0.33	0.10
1	500	0.0605	0.080	47.24	0.439	0.264	0.083
1	630	0.0469	0.063	59.52	0.481	0.255	0.080
1	800	0.0367	0.051	75.59	0.533	0.247	0.078
1	1000	0.0291	0.042	94.48	0.588	0.239	0.075

No. of Cores	Nominal Cross sectional Area	Max. DC Resistance at 20°C	Max. AC Resistance at 90°C	Short circuit current rating	Capacitance Approx.	Inductance Approx.	Reactance Approx.
No.	mm ²	Ω/km	Ω/km	kA/s	μF/km	mH/km	Ω/km
3	70	0.443	0.568	6.61	0.19	0.35	0.11
3	95	0.320	0.411	8.98	0.21	0.34	0.11
3	120	0.253	0.325	11.34	0.23	0.32	0.10
3	150	0.206	0.265	14.17	0.25	0.31	0.10
3	185	0.164	0.211	17.48	0.27	0.30	0.10
3	240	0.125	0.161	22.68	0.30	0.29	0.09
3	300	0.100	0.129	28.35	0.33	0.28	0.09
3	400	0.0778	0.101	37.79	0.37	0.27	0.09
3	500	0.0605	0.080	47.24	0.41	0.27	0.08
3	630	0.0469	0.063	59.52	0.45	0.26	0.08

CURRENT CARRYING CAPACITY:

No. of core	Nominal Cross sectional area	Continuous Current Rating					
		Buried direct in the ground		In single-way ducts		In air	
		Trefoil Amp.	Flat spaced Amp.	Trefoil ducts Amp.	Flat touching Amp.	Trefoil Amp.	Flat touching Amp.
No.	mm ²						
1	70	186	192	176	178	230	236
1	95	221	229	210	213	280	287
1	120	252	260	240	242	324	332
1	150	281	288	267	271	368	376
1	185	317	324	303	307	424	432
1	240	367	373	351	356	502	511
1	300	414	419	397	402	577	586
1	400	470	466	451	457	673	676
1	500	483	450	415	367	746	705
1	630	536	489	458	396	847	787
1	800	586	525	513	434	953	868
1	1000	618	549	538	450	1038	936

No. of core	Nominal Cross sectional area	Continuous current capacity		
		In ground at 20°C Amp.	In a buried duct Amp.	In air Amp.
No.	mm ²			
3	70	171	150	196
3	95	204	180	238
3	120	232	206	274
3	150	259	231	309
3	185	293	262	354
3	240	338	304	415
3	300	380	343	472
3	400	432	393	545
3	500	490	441	658

Maximum conductor temperature 90°C
 Ambient air temperature 30°C
 Ground temperature 20°C
 Depth of laying 0.8 m
 Thermal resistivity of soil 1.5 K.m/W
 Thermal resistivity of earthenware ducts 1.2 K.m/W

Current rating de-rating factors for other than 30°C ambient air temperature.

Air Temperature	20	25	35	40	45	50	55	60
De-rating factor	1.08	1.04	0.96	0.91	0.87	0.82	0.76	0.71

Current rating de-rating factors for other than 20°C ground temperature.

Ground Temperature	10	15	25	30	35	40	45	50
De-rating factor	1.07	1.04	0.96	0.93	0.89	0.85	0.8	0.76



OUR CERTIFICATION
ISO 9001 | ISO 14001 | ISO 45001



OUR CERTIFICATION
ISO 9001 | ISO 14001 | ISO 45001



POLYCAB MV AL BS 7835 19/33 KV
Medium Voltage Armoured Cable, 19/33 (36) KV AC

Single Core



Three Core



Outstanding Features

- Flame retardant
- High life
- UV resistant
- Oil resistant
- Low smoke emission

Application

POLYCAB MV AL BS 7835 19/33 KV XLPE insulated with aluminium conductor single & multi core cable is designed for low smoke & low halogen evolution and this suitable to use for power networks, underground and in cable ducting.

Voltage Rating

Nominal Voltage: 19/33 (36) kV

Operation Temperature

Max. operating temperature: +90°C
Max. Short Circuit Temperature: 250°C

Construction

- Conductor: Circular Compacted aluminium conductor as per BS EN/IEC 60228, class 2
- Conductor Screen: Extruded Semi-conductive compound
- Insulation: XLPE as per BS 7655-1.3 or EPR as per BS 7655-1.2
- Non-Metallic Insulation Screen: Extruded Semi-conductive compound
- Metallic Insulation Screen: Copper tape screen
- Inner Covering: Extruded LSZH (Low Smoke Zero Halogen) compound
- Armour:
 - Single Core: Aluminium Round Wire Armoured (AWA)
 - Multi Core: Galvanised Steel Round Wire Armoured (SWA)
- Outer Sheath: Extruded LSZH compound as per BS 7655-6.1, Colour: Black

Standard and References:

BS EN/IEC 60228
BS 7655-1.3/1.2
BS 7655-6.1
BS 7835

Test Voltage

76kV AC

Impulse Test Voltage

Peak 194kV AC

Compliance

- Conductor resistance BS EN/IEC 60228
- Insulation resistance BS 7835
- Flame Retardant test BS EN/IEC 60332-1-2
- Partial Discharge test BS 7835
- Smoke Emission test BS EN/IEC 61034-2

Approval



Bending Radius:

Single core cable
Fixed Installation: 15 x Overall diameter
Three core cable
Fixed Installation: 12 x Overall diameter

POLYCAB MV AL BS 7835 19/33 KV
Medium Voltage Armoured Cable, 19/33 (36) KV AC

DIMENSIONAL CHARACTERISTICS:

Product Code	No. of Cores	Nominal Cross sectional Area	Nominal Diameter			Weight (Approx.)
			Under armour	Over armour	Overall	
	No.	mm ²	mm	mm	mm	Kg/Km
MVBS20AXAWLS001C070S	1	70	30.4	34.4	39.0	1750
MVBS20AXAWLS001C095S	1	95	32.2	36.2	41.0	1950
MVBS20AXAWLS001C120S	1	120	33.8	37.8	42.0	2150
MVBS20AXAWLS001C150S	1	150	35.5	39.5	44.0	2300
MVBS20AXAWLS001C185S	1	185	37.2	42.2	47.0	2650
MVBS20AXAWLS001C240S	1	240	40.0	45.0	50.0	3050
MVBS20AXAWLS001C300S	1	300	42.5	47.5	53.0	3450
MVBS20AXAWLS001C400S	1	400	45.7	50.7	56.0	3900
MVBS20AXAWLS001C500S	1	500	49.0	54.0	60.0	4450
MVBS20AXAWLS001C630S	1	630	52.8	57.8	64.0	5150
MVBS20AXAWLS001C800S	1	800	56.9	61.9	68.0	5950
MVBS20AXAWLS001C01KS	1	1000	61.2	66.2	72.0	6800
MVBS20AXSWLS003C070S	3	70	64.3	70.6	77.0	8800
MVBS20AXSWLS003C095S	3	95	68.1	74.4	81.0	9600
MVBS20AXSWLS003C120S	3	120	71.5	77.8	85.0	10400
MVBS20AXSWLS003C150S	3	150	75.2	81.5	89.0	11250
MVBS20AXSWLS003C185S	3	185	78.8	85.1	93.0	12200
MVBS20AXSWLS003C240S	3	240	84.2	90.5	99.0	13550
MVBS20AXSWLS003C300S	3	300	90.0	96.3	105.0	15200
MVBS20AXSWLS003C400S	3	400	96.9	103.2	112.0	17250
MVBS20AXSWLS003C500S	3	500	104.0	110.3	120.0	19500
MVBS20AXSWLS003C630S	3	630	111.3	117.6	127.0	22000



ELECTRICAL CHARACTERISTICS:

No. of Core	Nominal Cross sectional Area	Max. DC Resistance at 20°C	Max. AC Resistance at 90°C	Short circuit current rating	Capacitance Approx.	Inductance Approx.	Reactance Approx.
No.	mm ²	Ω/km	Ω/km	kA/s	μF/km	mH/km	Ω/km
1	70	0.443	0.568	6.61	0.15	0.45	0.14
1	95	0.320	0.411	8.98	0.16	0.43	0.13
1	120	0.253	0.325	11.34	0.18	0.41	0.13
1	150	0.206	0.265	14.17	0.19	0.40	0.12
1	185	0.164	0.211	17.48	0.21	0.39	0.12
1	240	0.125	0.161	22.68	0.23	0.37	0.12
1	300	0.100	0.129	28.35	0.25	0.36	0.11
1	400	0.0778	0.101	37.79	0.28	0.35	0.11
1	500	0.0605	0.080	47.24	0.321	0.283	0.089
1	630	0.0469	0.063	59.52	0.350	0.274	0.086
1	800	0.0367	0.051	75.59	0.386	0.263	0.083
1	1000	0.0291	0.042	94.48	0.424	0.254	0.080

No. of Cores	Nominal Cross sectional Area	Max. DC Resistance at 20°C	Max. AC Resistance at 90°C	Short circuit current rating	Capacitance Approx.	Inductance Approx.	Reactance Approx.
No.	mm ²	Ω/km	Ω/km	kA/s	μF/km	mH/km	Ω/km
3	70	0.443	0.568	6.61	0.15	0.39	0.12
3	95	0.320	0.411	8.98	0.16	0.37	0.12
3	120	0.253	0.325	11.34	0.18	0.36	0.11
3	150	0.206	0.265	14.17	0.19	0.35	0.11
3	185	0.164	0.211	17.48	0.21	0.34	0.11
3	240	0.125	0.161	22.68	0.23	0.32	0.10
3	300	0.100	0.129	28.35	0.25	0.31	0.10
3	400	0.0778	0.101	37.79	0.28	0.30	0.09
3	500	0.0605	0.080	47.24	0.31	0.289	0.091
3	630	0.0469	0.063	59.52	0.33	0.281	0.088

CURRENT CARRYING CAPACITY:

No. of core	Nominal Cross sectional area	Continuous Current Rating					
		Buried direct in the ground		In single-way ducts		In air	
		Trefoil Amp.	Flat spaced Amp.	Trefoil ducts Amp.	Flat touching Amp.	Trefoil Amp.	Flat touching Amp.
No.	mm ²						
1	70	186	192	176	178	230	236
1	95	221	229	210	213	280	287
1	120	252	260	240	242	324	332
1	150	281	288	267	271	368	376
1	185	317	324	303	307	424	432
1	240	367	373	351	356	502	511
1	300	414	419	397	402	577	586
1	400	470	466	451	457	673	676
1	500	483	450	415	367	746	705
1	630	536	489	458	396	847	787
1	800	586	525	513	434	953	868
1	1000	618	549	538	450	1038	936

No. of core	Nominal Cross sectional area	Continuous current capacity		
		In ground at 20°C Amp.	In a buried duct Amp.	In air Amp.
No.	mm ²			
3	70	171	150	196
3	95	204	180	238
3	120	232	206	274
3	150	259	231	309
3	185	293	262	354
3	240	338	304	415
3	300	380	343	472
3	400	432	393	545
3	500	490	441	658

Maximum conductor temperature 90°C
 Ambient air temperature 30°C
 Ground temperature 20°C
 Depth of laying 0.8 m
 Thermal resistivity of soil 1.5 K.m/W
 Thermal resistivity of earthenware ducts 1.2 K.m/W

Current rating de-rating factors for other than 30°C ambient air temperature.

Air Temperature	20	25	35	40	45	50	55	60
De-rating factor	1.08	1.04	0.96	0.91	0.87	0.82	0.76	0.71

Current rating de-rating factors for other than 20°C ground temperature.

Ground Temperature	10	15	25	30	35	40	45	50
De-rating factor	1.07	1.04	0.96	0.93	0.89	0.85	0.8	0.76



OUR CERTIFICATION
ISO 9001 | ISO 14001 | ISO 45001



OUR CERTIFICATION
ISO 9001 | ISO 14001 | ISO 45001



POLYCAB MV CU BS 7835 8.7/15 KV
Medium Voltage Armoured Cable, 8.7/15 (17.5) KV AC

Single Core



Three Core



Outstanding Features

- Flame retardant
- High life
- UV resistant
- Oil resistant
- Low smoke emission

Application

POLYCAB MV CU BS 7835 8.7/15 KV XLPE insulated with copper conductor single & multi core cable is designed for low smoke & low halogen evolution and this suitable to use for power networks, underground and in cable ducting.

Voltage Rating

Nominal Voltage: 8.7/15 (17.5) kV

Operation Temperature

Max. operating temperature: +90°C
Max. Short Circuit Temperature: 250°C

Construction

- Conductor: Circular Compacted Copper conductor as per BS EN/IEC 60228, class 2
- Conductor Screen: Extruded Semi-conductive compound
- Insulation: XLPE as per BS 7655-1.3 or EPR as per BS 7655-1.2
- Non-Metallic Insulation Screen: Extruded Semi-conductive compound
- Metallic Insulation Screen: Copper tape screen
- Inner Covering: Extruded LSZH (Low Smoke Zero Halogen) compound
- Armour:
 - Single Core: Aluminium Round Wire Armoured (AWA)
 - Multi Core: Galvanised Steel Round Wire Armoured (SWA)
- Outer Sheath: Extruded LSZH compound as per BS 7655-6.1, Colour: Black

Standard and References:

BS EN/IEC 60228
BS 7655-1.3/1.2
BS 7655-6.1
BS 7835

Test Voltage

35kV AC

Impulse Test Voltage

Peak 112kV AC

Compliance

- Conductor resistance BS EN/IEC 60228
- Insulation resistance BS 7835
- Flame Retardant test BS EN/IEC 60332-1-2
- Partial Discharge test BS 7835
- Smoke emission test BS EN/IEC 61034-2

Approval



Bending Radius:

Single core cable
Fixed Installation: 15 x Overall diameter
Three core cable
Fixed Installation: 12 x Overall diameter

POLYCAB MV CU BS 7835 8.7/15 KV
Medium Voltage Armoured Cable, 8.7/15 (17.5) KV AC

DIMENSIONAL CHARACTERISTICS:

Product Code	No. of Cores	Nominal Cross sectional Area	Nominal Diameter			Weight (Approx.)
			Under armour	Over armour	Overall	
	No.	mm ²	mm	mm	mm	Kg/Km
MVBS23CXAWLS001C070S	1	70	23.0	26.2	30.0	1600
MVBS23CXAWLS001C095S	1	95	24.8	28.0	32.0	1950
MVBS23CXAWLS001C120S	1	120	26.4	30.4	34.0	2250
MVBS23CXAWLS001C150S	1	150	28.5	32.5	37.0	2650
MVBS23CXAWLS001C185S	1	185	30.2	34.2	38.0	3050
MVBS23CXAWLS001C240S	1	240	32.6	36.6	41.0	3700
MVBS23CXAWLS001C300S	1	300	35.1	39.1	44.0	4450
MVBS23CXAWLS001C400S	1	400	38.3	43.3	48.0	5600
MVBS23CXAWLS001C500S	1	500	42.0	47.0	52.0	6850
MVBS23CXAWLS001C630S	1	630	45.4	50.4	56.0	8200
MVBS23CXAWLS001C800S	1	800	49.5	54.5	60.0	10000
MVBS23CXAWLS001C01KS	1	1000	54.2	59.2	65.0	12200
MVBS23CXSWLS003C070S	3	70	48.8	53.8	59.0	6700
MVBS23CXSWLS003C095S	3	95	52.6	57.6	64.0	7850
MVBS23CXSWLS003C120S	3	120	56.0	61.0	67.0	8950
MVBS23CXSWLS003C150S	3	150	59.7	64.7	71.0	10300
MVBS23CXSWLS003C185S	3	185	63.3	69.6	76.0	12450
MVBS23CXSWLS003C240S	3	240	69.1	75.4	82.0	14850
MVBS23CXSWLS003C300S	3	300	74.4	80.7	88.0	17350
MVBS23CXSWLS003C400S	3	400	81.4	87.7	96.0	21100
MVBS23CXSWLS003C500S	3	500	88.9	95.2	103.0	25300
MVBS23CXSWLS003C630S	3	630	96.1	102.4	111.0	29600



POLYCAB MV CU BS 7835 8.7/15 KV
Medium Voltage Armoured Cable, 8.7/15 (17.5) KV AC

ELECTRICAL CHARACTERISTICS:

No. of Core	Nominal Cross sectional Area	Max. DC Resistance at 20°C	Max. AC Resistance at 90°C	Short circuit current rating	Capacitance Approx.	Inductance Approx.	Reactance Approx.
No.	mm ²	Ω/km	Ω/km	kA/s	μF/km	mH/km	Ω/km
1	70	0.268	0.342	10.02	0.22	0.40	0.13
1	95	0.193	0.247	13.59	0.24	0.38	0.12
1	120	0.153	0.196	17.17	0.27	0.37	0.12
1	150	0.124	0.159	21.46	0.29	0.36	0.11
1	185	0.0991	0.128	26.47	0.32	0.35	0.11
1	240	0.0754	0.098	34.34	0.35	0.33	0.10
1	300	0.0601	0.080	42.93	0.39	0.32	0.10
1	400	0.047	0.064	57.23	0.44	0.32	0.10
1	500	0.0366	0.052	71.54	0.522	0.256	0.080
1	630	0.0283	0.042	90.14	0.574	0.247	0.078
1	800	0.0221	0.036	114.47	0.638	0.239	0.075
1	1000	0.0176	0.032	143.08	0.704	0.232	0.073

No. of Cores	Nominal Cross sectional Area	Max. DC Resistance at 20°C	Max. AC Resistance at 90°C	Short circuit current rating	Capacitance Approx.	Inductance Approx.	Reactance Approx.
No.	mm ²	Ω/km	Ω/km	kA/s	μF/km	mH/km	Ω/km
3	70	0.268	0.342	10.02	0.22	0.34	0.11
3	95	0.193	0.247	13.59	0.24	0.32	0.10
3	120	0.153	0.196	17.17	0.27	0.31	0.10
3	150	0.124	0.159	21.46	0.29	0.30	0.09
3	185	0.0991	0.128	26.47	0.32	0.29	0.09
3	240	0.0754	0.098	34.34	0.35	0.28	0.09
3	300	0.0601	0.080	42.93	0.39	0.27	0.09
3	400	0.047	0.064	57.23	0.44	0.26	0.08
3	500	0.0366	0.052	71.54	0.48	0.256	0.080
3	630	0.0283	0.042	90.14	0.53	0.250	0.079

POLYCAB MV CU BS 7835 8.7/15 KV
Medium Voltage Armoured Cable, 8.7/15 (17.5) KV AC

CURRENT CARRYING CAPACITY:

No. of core	Nominal Cross sectional area	Continuous Current Rating					
		Buried direct in the ground		In single-way ducts		In air	
		Trefoil Amp.	Flat spaced Amp.	Trefoil ducts Amp.	Flat touching Amp.	Trefoil Amp.	Flat touching Amp.
1	70	239	246	227	229	296	303
1	95	285	293	271	274	361	369
1	120	323	332	308	311	417	426
1	150	361	366	343	347	473	481
1	185	406	410	387	391	543	550
1	240	469	470	447	453	641	647
1	300	526	524	504	510	735	739
1	400	590	572	564	571	845	837
1	500	604	551	525	454	911	837
1	630	660	588	571	482	1023	919
1	800	690	594	594	484	1103	960
1	1000	726	615	621	497	1191	1020

No. of core	Nominal Cross sectional area	Continuous current capacity		
		In ground at 20°C Amp.	In a buried duct Amp.	In air Amp.
3	70	220	194	253
3	95	263	232	307
3	120	298	264	352
3	150	332	296	397
3	185	374	335	453
3	240	431	387	529
3	300	482	435	599
3	400	541	492	683
3	500	610	537	804

Maximum conductor temperature 90°C
Ambient air temperature 30°C
Ground temperature 20°C
Depth of laying 0.8 m
Thermal resistivity of soil 1.5 K.m/W
Thermal resistivity of earthenware ducts 1.2 K.m/W

Current rating de-rating factors for other than 30°C ambient air temperature.

Air Temperature	20	25	35	40	45	50	55	60
De-rating factor	1.08	1.04	0.96	0.91	0.87	0.82	0.76	0.71

Current rating de-rating factors for other than 20°C ground temperature.

Ground Temperature	10	15	25	30	35	40	45	50
De-rating factor	1.07	1.04	0.96	0.93	0.89	0.85	0.8	0.76



OUR CERTIFICATION
ISO 9001 | ISO 14001 | ISO 45001



OUR CERTIFICATION
ISO 9001 | ISO 14001 | ISO 45001



POLYCAB MV CU BS 7835 3.8/6.6 KV
Medium Voltage Armoured Cable, 3.8/6.6 (7.2) KV AC

Single Core



Three Core



Outstanding Features

- Flame retardant
- High life
- UV resistant
- Oil resistant
- Low smoke emission

Application

POLYCAB MV CU BS 7835 3.8/6.6 KV XLPE insulated with copper conductor single & multi core cable is designed for low smoke & low halogen evolution and this suitable to use for power distribution for external and direct burial applications in power network system.

Voltage Rating

Nominal Voltage: 3.8/6.6 (7.2) kV

Operation Temperature

Max. operating temperature: +90°C
Max. Short Circuit Temperature: 250°C

Construction

- Conductor: Circular Compacted Copper conductor as per BS EN/IEC 60228, class 2
- Conductor Screen: Extruded Semi-conductive compound
- Insulation: XLPE as per BS 7655 – 1.3 or EPR as per BS 7655-1.2
- Non-Metallic Insulation Screen: Extruded Semi-conductive compound
- Metallic Insulation Screen: Copper tape screen
- Inner Covering: Extruded LSZH (Low Smoke Zero Halogen) Compound
- Armour:
Single Core: Aluminium Round Wire Armoured (AWA)
Multi Core: Galvanised Steel Round Wire Armoured (SWA)
- Outer Sheath: Extruded LSZH compound as per BS 7655-6.1, Colour: Black

Standard and References:

BS EN/IEC 60228
BS 7655-1.3/1.2
BS 7655-6.1
BS 7835

Test Voltage

15kV AC

Impulse Test Voltage

Peak 75kV AC

Compliance

- Conductor resistance BS EN/IEC 60228
- Insulation resistance BS 7835
- Flame Retardant test BS EN/IEC 60332-1-2
- Partial Discharge test BS 7835
- Smoke emission test BS EN/IEC 61034-2

Approval



POLYCAB MV CU BS 7835 3.8/6.6 KV
Medium Voltage Armoured Cable, 3.8/6.6 (7.2) KV AC

DIMENSIONAL CHARACTERISTICS:

Product Code	No. of Cores	Nominal Cross sectional Area	Nominal Diameter			Weight (Approx.)
			Under armour	Over armour	Overall	
	No.	mm ²	mm	mm	mm	Kg/Km
MVBS21CXAWLS001C070S	1	70	19.00	22.20	26.0	1300
MVBS21CXAWLS001C095S	1	95	20.80	24.00	28.0	1600
MVBS21CXAWLS001C120S	1	120	22.40	25.60	29.5	1900
MVBS21CXAWLS001C150S	1	150	24.10	27.30	31.5	2250
MVBS21CXAWLS001C185S	1	185	25.80	29.00	33.0	2600
MVBS21CXAWLS001C240S	1	240	28.80	32.80	37.0	3350
MVBS21CXAWLS001C300S	1	300	31.70	35.70	40.5	4050
MVBS21CXAWLS001C400S	1	400	35.30	39.30	44.0	5100
MVBS21CXAWLS001C500S	1	500	39.00	44.00	49.0	6400
MVBS21CXAWLS001C630S	1	630	42.90	47.90	53.0	7800
MVBS21CXAWLS001C800S	1	800	46.90	51.90	57.5	9550
MVBS21CXAWLS001C01KS	1	1000	51.60	56.60	62.5	11650
MVBS21CXSWLS003C070S	3	70	39.70	44.70	50.0	5450
MVBS21CXSWLS003C095S	3	95	43.60	48.60	54.0	6550
MVBS21CXSWLS003C120S	3	120	46.90	51.90	58.0	7600
MVBS21CXSWLS003C150S	3	150	51.10	56.10	62.0	9000
MVBS21CXSWLS003C185S	3	185	54.70	59.70	66.0	10300
MVBS21CXSWLS003C240S	3	240	60.40	65.40	72.0	12500
MVBS21CXSWLS003C300S	3	300	67.10	73.40	80.0	16050
MVBS21CXSWLS003C400S	3	400	74.90	81.20	89.0	19800
MVBS21CXSWLS003C500S	3	500	82.00	88.30	96.0	23750
MVBS21CXSWLS003C630S	3	630	89.90	96.20	104.0	28600



ELECTRICAL CHARACTERISTICS:

No. of Core	Nominal Cross sectional Area	Max. DC Resistance at 20°C	Max. AC Resistance at 90°C	Short circuit current rating	Capacitance Approx.	Inductance Approx.	Reactance Approx.
No.	mm ²	Ω/km	Ω/km	kA/s	μF/km	mH/km	Ω/km
1	70	0.268	0.342	10.02	0.33	0.37	0.12
1	95	0.193	0.247	13.59	0.38	0.35	0.11
1	120	0.153	0.196	17.17	0.41	0.34	0.11
1	150	0.124	0.159	21.46	0.46	0.33	0.10
1	185	0.0991	0.128	26.47	0.50	0.32	0.10
1	240	0.0754	0.098	34.34	0.54	0.31	0.10
1	300	0.0601	0.080	42.93	0.57	0.31	0.10
1	400	0.047	0.064	57.23	0.61	0.30	0.09
1	500	0.0366	0.052	71.54	0.708	0.24	0.08
1	630	0.0283	0.042	90.14	0.784	0.24	0.07
1	800	0.0221	0.036	114.47	0.870	0.23	0.07
1	1000	0.0176	0.032	143.08	0.963	0.22	0.07

No. of Cores	Nominal Cross sectional Area	Max. DC Resistance at 20°C	Max. AC Resistance at 90°C	Short circuit current rating	Capacitance Approx.	Inductance Approx.	Reactance Approx.
No.	mm ²	Ω/km	Ω/km	kA/s	μF/km	mH/km	Ω/km
3	70	0.268	0.342	10.02	0.33	0.30	0.092
3	95	0.193	0.247	13.59	0.38	0.29	0.088
3	120	0.153	0.196	17.17	0.41	0.28	0.085
3	150	0.124	0.159	21.46	0.46	0.27	0.083
3	185	0.0991	0.128	26.47	0.50	0.26	0.081
3	240	0.0754	0.098	34.34	0.54	0.26	0.079
3	300	0.0601	0.080	42.93	0.57	0.25	0.078
3	400	0.047	0.064	57.23	0.61	0.25	0.077
3	500	0.0366	0.052	71.54	0.68	0.25	0.075
3	630	0.0283	0.042	90.14	0.75	0.25	0.074

CURRENT CARRYING CAPACITY:

No. of core	Nominal Cross sectional area	Continuous Current Rating					
		Buried direct in the ground		In single-way ducts		In air	
		Trefoil Amp.	Flat spaced Amp.	Trefoil ducts Amp.	Flat touching Amp.	Trefoil Amp.	Flat touching Amp.
No.	mm ²						
1	70	239	246	227	229	296	303
1	95	285	293	271	274	361	369
1	120	323	332	308	311	417	426
1	150	361	366	343	347	473	481
1	185	406	410	387	391	543	550
1	240	469	470	447	453	641	647
1	300	526	524	504	510	735	739
1	400	590	572	564	571	845	837
1	500	604	550	525	454	911	837
1	630	660	586	571	482	1022	917
1	800	689	593	593	483	1102	959
1	1000	726	615	621	497	1191	1020

No. of core	Nominal Cross sectional area	Continuous current capacity		
		In ground at 20°C Amp.	In a buried duct Amp.	In air Amp.
No.	mm ²			
3	70	220	194	253
3	95	263	232	307
3	120	298	264	352
3	150	332	296	397
3	185	374	335	453
3	240	431	387	529
3	300	482	435	599
3	400	541	492	683
3	500	610	537	803

Maximum conductor temperature 90°C
 Ambient air temperature 30°C
 Ground temperature 20°C
 Depth of laying 0.8 m
 Thermal resistivity of soil 1.5 K.m/W
 Thermal resistivity of earthenware ducts 1.2 K.m/W

Current rating de-rating factors for other than 30°C ambient air temperature.

Air Temperature	20	25	35	40	45	50	55	60
De-rating factor	1.08	1.04	0.96	0.91	0.87	0.82	0.76	0.71

Current rating de-rating factors for other than 20°C ground temperature.

Ground Temperature	10	15	25	30	35	40	45	50
De-rating factor	1.07	1.04	0.96	0.93	0.89	0.85	0.8	0.76



POLYCAB MV CU BS 7835 6.35/11 KV
Medium Voltage Armoured Cable, 6.35/11 (12) KV AC

Single Core



Three Core



Outstanding Features

- Flame retardant
- High life
- UV resistant
- Oil resistant
- Low smoke emission

Application

POLYCAB MV BS 7835 6.35/11 KV XLPE insulated with copper conductor single & multi core cable is designed for low smoke & low halogen evolution and this suitable to use for power networks, underground and in cable ducting.

Voltage Rating

Nominal Voltage: 6.35/11 (12) kV

Operation Temperature

Max. operating temperature: +90°C
Max. Short Circuit Temperature: 250°C

Construction

- Conductor: Circular Compacted Copper conductor as per BS EN/IEC 60228, class 2
- Conductor Screen: Extruded Semi-conductive compound
- Insulation: XLPE as per BS 7655-1.3 or EPR as per BS 7655-1.2
- Non-Metallic Insulation Screen: Extruded Semi-conductive compound
- Metallic Insulation Screen: Copper tape screen
- Inner Covering: Extruded LSZH (Low Smoke Zero Halogen) compound
- Armour:
 - Single Core: Aluminium Round Wire Armoured (AWA)
 - Multi Core: Galvanised Steel Round Wire Armoured (SWA)
- Outer Sheath: Extruded LSZH compound as per BS 7655-6.1, Colour: Black

Standard and References:

BS EN/IEC 60228
BS 7655-1.3/1.2
BS 7655-6.1
BS 7835

Test Voltage

25.5kV AC

Impulse Test Voltage

Peak 95kV AC

Compliance

- Conductor resistance BS EN/IEC 60228
- Insulation resistance BS 7835
- Flame Retardant test BS EN/IEC 60332-1-2
- Partial Discharge test BS 7835
- Smoke emission test BS EN/IEC 61034-2

Approval



Bending Radius:

Single core cable
Fixed Installation: 15 x Overall diameter
Three core cable
Fixed Installation: 12 x Overall diameter

POLYCAB MV CU BS 7835 6.35/11 KV
Medium Voltage Armoured Cable, 6.35/11 (12) KV AC

DIMENSIONAL CHARACTERISTICS:

Product Code	No. of Cores	Nominal Cross sectional Area	Nominal Diameter			Weight (Approx.)
			Under armour	Over armour	Overall	
	No.	mm ²	mm	mm	mm	Kg/Km
MVBS22CXAWLS001C070S	1	70	20.8	24.0	28.0	1400
MVBS22CXAWLS001C095S	1	95	22.6	25.8	30.0	1700
MVBS22CXAWLS001C120S	1	120	24.2	27.4	31.0	2000
MVBS22CXAWLS001C150S	1	150	25.9	29.1	33.0	2350
MVBS22CXAWLS001C185S	1	185	28.0	32.0	36.0	2850
MVBS22CXAWLS001C240S	1	240	30.4	34.4	39.0	3450
MVBS22CXAWLS001C300S	1	300	32.9	36.9	41.0	4150
MVBS22CXAWLS001C400S	1	400	36.1	40.1	45.0	5150
MVBS22CXAWLS001C500S	1	500	39.4	44.4	49.0	6450
MVBS22CXAWLS001C630S	1	630	43.2	48.2	53.0	7850
MVBS22CXAWLS001C800S	1	800	47.3	52.3	58.0	9600
MVBS22CXAWLS001C01KS	1	1000	52.0	57.0	63.0	11700
MVBS22CXSWLS003C070S	3	70	43.6	48.6	54.0	6000
MVBS22CXSWLS003C095S	3	95	47.5	52.5	58.0	7100
MVBS22CXSWLS003C120S	3	120	51.2	56.2	62.0	8250
MVBS22CXSWLS003C150S	3	150	55.0	60.0	66.0	9600
MVBS22CXSWLS003C185S	3	185	58.6	63.6	70.0	10900
MVBS22CXSWLS003C240S	3	240	63.9	70.2	77.0	1395
0MVBS22CXSWLS003C300S	3	300	69.7	76.0	83.0	16600
MVBS22CXSWLS003C400S	3	400	76.6	82.9	90.0	20150
MVBS22CXSWLS003C500S	3	500	83.7	90.0	98.0	24150
MVBS22CXSWLS003C630S	3	630	91.4	97.7	106.0	28850



ELECTRICAL CHARACTERISTICS:

No. of Core	Nominal Cross sectional Area	Max. DC Resistance at 20°C	Max. AC Resistance at 90°C	Short circuit current rating	Capacitance Approx.	Inductance Approx.	Reactance Approx.
No.	mm ²	Ω/km	Ω/km	kA/s	μF/km	mH/km	Ω/km
1	70	0.268	0.342	10.02	0.26	0.38	0.12
1	95	0.193	0.247	13.59	0.30	0.37	0.12
1	120	0.153	0.196	17.17	0.33	0.35	0.11
1	150	0.124	0.159	21.46	0.36	0.34	0.11
1	185	0.0991	0.128	26.47	0.39	0.34	0.11
1	240	0.0754	0.098	34.34	0.44	0.32	0.10
1	300	0.0601	0.080	42.93	0.49	0.31	0.10
1	400	0.047	0.064	57.23	0.55	0.30	0.09
1	500	0.0366	0.052	71.54	0.670	0.245	0.077
1	630	0.0283	0.042	90.14	0.739	0.239	0.075
1	800	0.0221	0.036	10.02	0.823	0.231	0.073
1	1000	0.0176	0.032	13.59	0.911	0.225	0.071

No. of Cores	Nominal Cross sectional Area	Max. DC Resistance at 20°C	Max. AC Resistance at 90°C	Short circuit current rating	Capacitance Approx.	Inductance Approx.	Reactance Approx.
No.	mm ²	Ω/km	Ω/km	kA/s	μF/km	mH/km	Ω/km
3	70	0.268	0.342	10.02	0.26	0.31	0.098
3	95	0.193	0.247	13.59	0.30	0.30	0.094
3	120	0.153	0.196	17.17	0.33	0.29	0.090
3	150	0.124	0.159	21.46	0.36	0.28	0.088
3	185	0.0991	0.128	26.47	0.39	0.27	0.086
3	240	0.0754	0.098	34.34	0.44	0.26	0.083
3	300	0.0601	0.080	42.93	0.49	0.26	0.081
3	400	0.047	0.064	57.23	0.55	0.25	0.078
3	500	0.0366	0.052	71.54	0.61	0.244	0.077
3	630	0.0283	0.042	90.14	0.67	0.239	0.075

CURRENT CARRYING CAPACITY:

No. of core	Nominal Cross sectional area	Continuous Current Rating					
		Buried direct in the ground		In single-way ducts		In air	
		Trefoil Amp.	Flat spaced Amp.	Trefoil ducts Amp.	Flat touching Amp.	Trefoil Amp.	Flat touching Amp.
No.	mm ²						
1	70	239	246	227	229	296	303
1	95	285	293	271	274	361	369
1	120	323	332	308	311	417	426
1	150	361	366	343	347	473	481
1	185	406	410	387	391	543	550
1	240	469	470	447	453	641	647
1	300	526	524	504	510	735	739
1	400	590	572	564	571	845	837
1	500	604	551	525	454	911	837
1	630	660	588	571	482	1023	919
1	800	690	594	594	484	1103	960
1	1000	726	615	621	497	1191	1020

No. of core	Nominal Cross sectional area	Continuous current capacity		
		In ground at 20°C Amp.	In a buried duct Amp.	In air Amp.
No.	mm ²			
3	70	220	194	253
3	95	263	232	307
3	120	298	264	352
3	150	332	296	397
3	185	374	335	453
3	240	431	387	529
3	300	482	435	599
3	400	541	492	683
3	500	610	537	804

Maximum conductor temperature 90°C
Ambient air temperature 30°C
Ground temperature 20°C
Depth of laying 0.8 m
Thermal resistivity of soil 1.5 K.m/W
Thermal resistivity of earthenware ducts 1.2 K.m/W

Current rating de-rating factors for other than 30°C ambient air temperature.

Air Temperature	20	25	35	40	45	50	55	60
De-rating factor	1.08	1.04	0.96	0.91	0.87	0.82	0.76	0.71

Current rating de-rating factors for other than 20°C ground temperature.

Ground Temperature	10	15	25	30	35	40	45	50
De-rating factor	1.07	1.04	0.96	0.93	0.89	0.85	0.8	0.76



OUR CERTIFICATION
ISO 9001 | ISO 14001 | ISO 45001



OUR CERTIFICATION
ISO 9001 | ISO 14001 | ISO 45001



POLYCAB MV CU BS 7835 12.7/22 KV
Medium Voltage Armoured Cable, 12.7/22 (24) KV AC

Single Core



Three Core



Outstanding Features

- Flame retardant
- High life
- UV resistant
- Oil resistant
- Low smoke emission

Application

POLYCAB MV CU BS 7835 12.7/22 KV XLPE insulated with copper conductor single & multi core cable is designed for low smoke & low halogen evolution and this suitable to use for power networks, underground and in cable ducting.

Voltage Rating

Nominal Voltage: 12.7/22 (24) kV

Operation Temperature

Max. operating temperature: +90°C
Max. Short Circuit Temperature: 250°C

Construction

- Conductor: Circular Compacted Copper conductor as per BS EN/IEC 60228, class 2
- Conductor Screen: Extruded Semi-conductive compound
- Insulation: XLPE as per BS 7655-1.3 or EPR as per BS 7655-1.2
- Non-Metallic Insulation Screen: Extruded Semi-conductive compound
- Metallic Insulation Screen: Copper tape screen
- Inner Covering: Extruded LSZH (Low Smoke Zero Halogen) Compound
- Armour:
Single Core: Aluminium Round Wire Armoured (AWA)
Multi Core: Galvanised Steel Round Wire Armoured (SWA)
- Outer Sheath: Extruded LSZH compound as per BS 7655-6.1, Colour: Black

Bending Radius:

Single core cable
Fixed Installation: 15 x Overall diameter
Three core cable
Fixed Installation: 12 x Overall diameter

Standard and References:

BS EN/IEC 60228
BS 7655-1.3/1.2
BS 7655-6.1
BS 7835

Test Voltage

51kV AC

Impulse Test Voltage

Peak 144kV AC

Compliance

- Conductor resistance BS EN/IEC 60228
- Insulation resistance BS 7835
- Flame Retardant test BS EN/IEC 60332-1-2
- Partial Discharge test BS 7835
- Smoke Emission test BS EN/IEC 61034-2

Approval



POLYCAB MV CU BS 7835 12.7/22 KV
Medium Voltage Armoured Cable, 12.7/22 (24) KV AC

DIMENSIONAL CHARACTERISTICS:

Product Code	No. of Cores	Nominal Cross sectional Area	Nominal Diameter			Weight (Approx.)
			Under armour	Over armour	Overall	
	No.	mm ²	mm	mm	mm	Kg/Km
MVBS19CXAWLS001C070S	1	70	25.0	28.2	32.0	1800
MVBS19CXAWLS001C095S	1	95	26.8	30.8	35.0	2100
MVBS19CXAWLS001C120S	1	120	28.8	32.8	37.0	2450
MVBS19CXAWLS001C150S	1	150	30.5	34.5	39.0	2850
MVBS19CXAWLS001C185S	1	185	32.2	36.2	41.0	3250
MVBS19CXAWLS001C240S	1	240	34.6	38.6	43.0	3900
MVBS19CXAWLS001C300S	1	300	37.1	41.1	46.0	4600
MVBS19CXAWLS001C400S	1	400	40.7	45.7	51.0	5850
MVBS19CXAWLS001C500S	1	500	44.0	49.0	54.0	7050
MVBS19CXAWLS001C630S	1	630	47.4	52.4	58.0	8450
MVBS19CXAWLS001C800S	1	800	51.9	56.9	63.0	10300
MVBS19CXAWLS001C01KS	1	1000	56.2	61.2	67.0	12450
MVBS19CXSWLS003C070S	3	70	53.1	58.1	64.0	7350
MVBS19CXSWLS003C095S	3	95	56.9	61.9	68.0	8500
MVBS19CXSWLS003C120S	3	120	60.3	65.3	72.0	9650
MVBS19CXSWLS003C150S	3	150	64.4	70.7	78.0	11900
MVBS19CXSWLS003C185S	3	185	68.0	74.3	81.0	13350
MVBS19CXSWLS003C240S	3	240	73.4	79.7	87.0	15700
MVBS19CXSWLS003C300S	3	300	78.8	85.1	93.0	18250
MVBS19CXSWLS003C400S	3	400	85.7	92.0	100.0	21900
MVBS19CXAWLS003C500S	3	500	93.2	99.5	108.0	26100
MVBS19CXAWLS003C630S	3	630	100.5	106.8	116.0	30800



ELECTRICAL CHARACTERISTICS:

No. of Core	Nominal Cross sectional Area	Max. DC Resistance at 20°C	Max. AC Resistance at 90°C	Short circuit current rating	Capacitance Approx.	Inductance Approx.	Reactance Approx.
No.	mm ²	Ω/km	Ω/km	kA/s	μF/km	mH/km	Ω/km
1	70	0.268	0.342	10.02	0.19	0.41	0.13
1	95	0.193	0.247	13.59	0.21	0.40	0.13
1	120	0.153	0.196	17.17	0.23	0.38	0.12
1	150	0.124	0.159	21.46	0.25	0.37	0.12
1	185	0.0991	0.128	26.47	0.27	0.36	0.11
1	240	0.0754	0.098	34.34	0.30	0.34	0.11
1	300	0.0601	0.080	42.93	0.33	0.33	0.10
1	400	0.047	0.064	57.23	0.37	0.33	0.10
1	500	0.0366	0.052	71.54	0.439	0.264	0.083
1	630	0.0283	0.042	90.14	0.481	0.255	0.080
1	800	0.0221	0.036	10.02	0.533	0.247	0.078
1	1000	0.0176	0.032	13.59	0.588	0.239	0.075

No. of Cores	Nominal Cross sectional Area	Max. DC Resistance at 20°C	Max. AC Resistance at 90°C	Short circuit current rating	Capacitance Approx.	Inductance Approx.	Reactance Approx.
No.	mm ²	Ω/km	Ω/km	kA/s	μF/km	mH/km	Ω/km
3	70	0.268	0.342	10.02	0.19	0.35	0.11
3	95	0.193	0.247	13.59	0.21	0.34	0.11
3	120	0.153	0.196	17.17	0.23	0.32	0.10
3	150	0.124	0.159	21.46	0.25	0.31	0.10
3	185	0.0991	0.128	26.47	0.27	0.30	0.10
3	240	0.0754	0.098	34.34	0.30	0.29	0.09
3	300	0.0601	0.080	42.93	0.33	0.28	0.09
3	400	0.047	0.064	57.23	0.37	0.27	0.09
3	500	0.0366	0.052	71.54	0.41	0.27	0.08
3	630	0.0283	0.042	90.14	0.45	0.26	0.08

CURRENT CARRYING CAPACITY:

No. of core	Nominal Cross sectional area	Continuous Current Rating					
		Buried direct in the ground		In single-way ducts		In air	
		Trefoil Amp.	Flat spaced Amp.	Trefoil ducts Amp.	Flat touching Amp.	Trefoil Amp.	Flat touching Amp.
1	70	239	246	227	229	296	303
1	95	285	293	271	274	361	369
1	120	323	332	308	311	417	426
1	150	361	366	343	347	473	481
1	185	406	410	387	391	543	550
1	240	469	470	447	453	641	647
1	300	526	524	504	510	735	739
1	400	590	572	564	571	845	837
1	500	581	521	499	424	908	828
1	630	633	554	541	449	1012	905
1	800	679	583	594	483	1115	979
1	1000	694	596	605	489	1181	1032

No. of core	Nominal Cross sectional area	Continuous current capacity		
		In ground at 20°C Amp.	In a buried duct Amp.	In air Amp.
3	70	220	194	253
3	95	263	232	307
3	120	298	264	352
3	150	332	296	397
3	185	374	335	453
3	240	431	387	529
3	300	482	435	599
3	400	541	492	683
3	500	608	548	820

Maximum conductor temperature 90°C
Ambient air temperature 30°C
Ground temperature 20°C
Depth of laying 0.8 m
Thermal resistivity of soil 1.5 K.m/W
Thermal resistivity of earthenware ducts 1.2 K.m/W

Current rating de-rating factors for other than 30°C ambient air temperature.

Air Temperature	20	25	35	40	45	50	55	60
De-rating factor	1.08	1.04	0.96	0.91	0.87	0.82	0.76	0.71

Current rating de-rating factors for other than 20°C ground temperature.

Ground Temperature	10	15	25	30	35	40	45	50
De-rating factor	1.07	1.04	0.96	0.93	0.89	0.85	0.8	0.76



OUR CERTIFICATION
ISO 9001 | ISO 14001 | ISO 45001



OUR CERTIFICATION
ISO 9001 | ISO 14001 | ISO 45001



POLYCAB MV CU BS 7835 19/33 KV
Medium Voltage Armoured Cable, 19/33 (36) KV AC

Single Core



Three Core



Outstanding Features

- Flame retardant
- High life
- UV resistant
- Oil resistant
- Low smoke emission

Application

POLYCAB MV CU BS 7835 19/33 KV XLPE insulated with copper conductor single & multi core cable is designed for low smoke & low halogen evolution and this suitable to use for power networks, underground and in cable ducting.

Voltage Rating

Nominal Voltage: 19/33 (36) kV

Operation Temperature

Max. operating temperature: +90°C
Max. Short Circuit Temperature: 250°C

Construction

- Conductor: Circular Compacted Copper conductor as per BS EN/IEC 60228, class 2
- Conductor Screen: Extruded Semi-conductive compound
- Insulation: XLPE as per BS 7655-1.3 or EPR as per BS 7655-1.2
- Non-Metallic Insulation Screen: Extruded Semi-conductive compound
- Metallic Insulation Screen: Copper tape screen
- Inner Covering: Extruded LSZH (Low Smoke Zero Halogen) compound
- Armour:
 - Single Core: Aluminium Round Wire Armoured (AWA)
 - Multi Core: Galvanised Steel Round Wire Armoured (SWA)
- Outer Sheath: Extruded LSZH compound as per BS 7655-6.1, Colour: Black

Standard and References:

BS EN/IEC 60228
BS 7655-1.3/1.2
BS 7655-6.1
BS 7835

Test Voltage

76kV AC

Impulse Test Voltage

Peak 194kV AC

Compliance

- Conductor resistance BS EN/IEC 60228
- Insulation resistance BS 7835
- Flame Retardant test BS EN/IEC 60332-1-2
- Partial Discharge test BS 7835
- Smoke Emission test BS EN/IEC 61034-2

Approval



POLYCAB MV CU BS 7835 19/33 KV
Medium Voltage Armoured Cable, 19/33 (36) KV AC

DIMENSIONAL CHARACTERISTICS:

Product Code	No. of Cores	Nominal Cross sectional Area	Nominal Diameter			Weight (Approx.)
			Under armour	Over armour	Overall	
	No.	mm ²	mm	mm	mm	Kg/Km
MVBS20CXAWLS001C070S	1	70	30.4	34.4	39.0	2200
MVBS20CXAWLS001C095S	1	95	32.2	36.2	41.0	2550
MVBS20CXAWLS001C120S	1	120	33.8	37.8	42.0	2900
MVBS20CXAWLS001C150S	1	150	35.5	39.5	44.0	3250
MVBS20CXAWLS001C185S	1	185	37.2	42.2	47.0	3850
MVBS20CXAWLS001C240S	1	240	40.0	45.0	50.0	4600
MVBS20CXAWLS001C300S	1	300	42.5	47.5	53.0	5350
MVBS20CXAWLS001C400S	1	400	45.7	50.7	56.0	6450
MVBS20CXAWLS001C500S	1	500	49.0	54.0	60.0	7650
MVBS20CXAWLS001C630S	1	630	52.8	57.8	64.0	9150
MVBS20CXAWLS001C800S	1	800	56.9	61.9	68.0	11000
MVBS20CXAWLS001C01KS	1	1000	61.2	66.2	72.0	13150
MVBS20CXSWLS003C070S	3	70	64.3	70.6	77.0	10150
MVBS20CXSWLS003C095S	3	95	68.1	74.4	81.0	11400
MVBS20CXSWLS003C120S	3	120	71.5	77.8	85.0	12650
MVBS20CXSWLS003C150S	3	150	75.2	81.5	89.0	14100
MVBS20CXSWLS003C185S	3	185	78.8	85.1	93.0	15700
MVBS20CXSWLS003C240S	3	240	84.2	90.5	99.0	18100
MVBS20CXSWLS003C300S	3	300	90.0	96.3	105.0	21000
MVBS20CXSWLS003C400S	3	400	96.9	103.2	112.0	24800
MVBS20CXSWLS003C500S	3	500	104.0	110.3	120.0	29050
MVBS20CXSWLS003C630S	3	630	111.3	117.6	127.0	33900



ELECTRICAL CHARACTERISTICS:

No. of Core	Nominal Cross sectional Area	Max. DC Resistance at 20°C	Max. AC Resistance at 90°C	Short circuit current rating	Capacitance Approx.	Inductance Approx.	Reactance Approx.
No.	mm ²	Ω/km	Ω/km	kA/s	μF/km	mH/km	Ω/km
1	70	0.268	0.342	10.02	0.15	0.45	0.14
1	95	0.193	0.247	13.59	0.16	0.43	0.13
1	120	0.153	0.196	17.17	0.18	0.41	0.13
1	150	0.124	0.159	21.46	0.19	0.40	0.12
1	185	0.0991	0.128	26.47	0.21	0.39	0.12
1	240	0.0754	0.098	34.34	0.23	0.37	0.12
1	300	0.0601	0.080	42.93	0.25	0.36	0.11
1	400	0.047	0.064	57.23	0.28	0.35	0.11
1	500	0.0366	0.052	71.54	0.321	0.283	0.089
1	630	0.0283	0.042	90.14	0.350	0.274	0.086
1	800	0.0221	0.036	10.02	0.386	0.263	0.083
1	1000	0.0176	0.032	13.59	0.424	0.254	0.080

No. of Cores	Nominal Cross sectional Area	Max. DC Resistance at 20°C	Max. AC Resistance at 90°C	Short circuit current rating	Capacitance Approx.	Inductance Approx.	Reactance Approx.
No.	mm ²	Ω/km	Ω/km	kA/s	μF/km	mH/km	Ω/km
3	70	0.268	0.342	10.02	0.15	0.39	0.12
3	95	0.193	0.247	13.59	0.16	0.37	0.12
3	120	0.153	0.196	17.17	0.18	0.36	0.11
3	150	0.124	0.159	21.46	0.19	0.35	0.11
3	185	0.0991	0.128	26.47	0.21	0.34	0.11
3	240	0.0754	0.098	34.34	0.23	0.32	0.10
3	300	0.0601	0.080	42.93	0.25	0.31	0.10
3	400	0.047	0.064	57.23	0.28	0.30	0.09
3	500	0.0366	0.052	71.54	0.31	0.289	0.091
3	630	0.0283	0.042	90.14	0.33	0.281	0.088

CURRENT CARRYING CAPACITY:

No. of core	Nominal Cross sectional area	Continuous Current Rating					
		Buried direct in the ground		In single-way ducts		In air	
		Trefoil Amp.	Flat spaced Amp.	Trefoil ducts Amp.	Flat touching Amp.	Trefoil Amp.	Flat touching Amp.
1	70	239	246	227	229	296	303
1	95	285	293	271	274	361	369
1	120	323	332	308	311	417	426
1	150	361	366	343	347	473	481
1	185	406	410	387	391	543	550
1	240	469	470	447	453	641	647
1	300	526	524	504	510	735	739
1	400	590	572	564	571	845	837
1	500	581	521	499	424	908	828
1	630	633	554	541	449	1012	905
1	800	679	583	594	483	1115	979
1	1000	694	596	605	489	1181	1032

No. of core	Nominal Cross sectional area	Continuous current capacity		
		In ground at 20°C Amp.	In a buried duct Amp.	In air Amp.
3	70	220	194	253
3	95	263	232	307
3	120	298	264	352
3	150	332	296	397
3	185	374	335	453
3	240	431	387	529
3	300	482	435	599
3	400	541	492	683
3	500	608	548	820

Maximum conductor temperature 90°C
Ambient air temperature 30°C
Ground temperature 20°C
Depth of laying 0.8 m
Thermal resistivity of soil 1.5 K.m/W
Thermal resistivity of earthenware ducts 1.2 K.m/W

Current rating de-rating factors for other than 30°C ambient air temperature.

Air Temperature	20	25	35	40	45	50	55	60
De-rating factor	1.08	1.04	0.96	0.91	0.87	0.82	0.76	0.71

Current rating de-rating factors for other than 20°C ground temperature.

Ground Temperature	10	15	25	30	35	40	45	50
De-rating factor	1.07	1.04	0.96	0.93	0.89	0.85	0.8	0.76



OUR CERTIFICATION
ISO 9001 | ISO 14001 | ISO 45001



OUR CERTIFICATION
ISO 9001 | ISO 14001 | ISO 45001



Polycab, Medium Voltage Copper Wire Screened Power cable conforming to BS 7870-4-10



These includes medium voltage copper wire screened cable confirming the construction and performance of voltage rating 6.35/11 (12) KV, 12.7/22 (24) KV and 19/33 (36) KV as per BS 7870-4-10. These cables are designed use in power networks, underground direct buried or in cable ducting.

These cables are available in single core and triplex formation with maximum operating conductor temperature of 90°C and maximum short circuit conductor temperature 250°C.

Conductor: High conductivity stranded compacted copper or aluminium conductor produced in-house from state-of-the art machine.

Screen: Semi-conducting compound

Insulation: High insulation resistance cross-linked polyethylene or EPR insulation.

Screen: Insulation screened by semi-conducting compound followed by copper wire and copper tape.

Separator: Water swellable tape applied below and over the metallic screen.

Sheath: In-house developed Medium density polyethylene or Low smoke zero halogen compounding sheath to withstand mechanical abrasion and weather while in use.

Polycab assures the highest quality standard in every product by having stringent quality control with requisite testing which are applied at every single stage from raw material to finished goods.

The construction based on the application and requirement of the user against BS 7870-4-10.



POLYCAB MV CU BS 7870-4-10 6.35/11 KV - Medium Voltage Copper wire screened Cable, 6.35/11 (12) KV AC



POLYCAB MV CU BS 7870-4-10 12.7/22 KV - Medium Voltage Copper wire screened Cable, 12.7/22 (24) KV AC



POLYCAB MV CU BS 7870-4-10 19/33 KV - Medium Voltage Copper wire screened Cable, 19/33 (36) KV AC



POLYCAB MV AL BS 7870-4-10 6.35/11 KV - Medium Voltage Copper wire screened Cable, 6.35/11 (12) KV AC



POLYCAB MV AL BS 7870-4-10 12.7/22 KV - Medium Voltage Copper wire screened Cable, 12.7/22 (24) KV AC



POLYCAB MV AL BS 7870-4-10 19/33 KV - Medium Voltage Copper wire screened Cable, 19/33 (36) KV AC



POLYCAB MV AL BS 7870-4-10 6.35/11 KV Triplex - Medium Voltage Copper wire screened Cable, 6.35/11 (12) KV AC



POLYCAB MV AL BS 7870-4-10 12.7/22 KV Triplex - Medium Voltage Copper wire screened Cable, 12.7/22 (24) KV AC



POLYCAB MV AL BS 7870-4-10 19/33 KV Triplex - Medium Voltage Copper wire screened Cable, 19/33 (36) KV AC



POLYCAB MV CU BS 7870-4-10 6.35/11 KV Triplex - Medium Voltage Copper wire screened Cable, 6.35/11 (12) KV AC



POLYCAB MV CU BS 7870-4-10 12.7/22 KV Triplex - Medium Voltage Copper wire screened Cable, 12.7/22 (24) KV AC



POLYCAB MV CU BS 7870-4-10 19/33 KV Triplex - Medium Voltage Copper wire screened Cable, 19/33 (36) KV AC

POLYCAB MV AL BS 7870-4-10 6.35/11 KV Triplex
Medium Voltage Copper wire screened Cable, 6.35/11 (12) KV AC

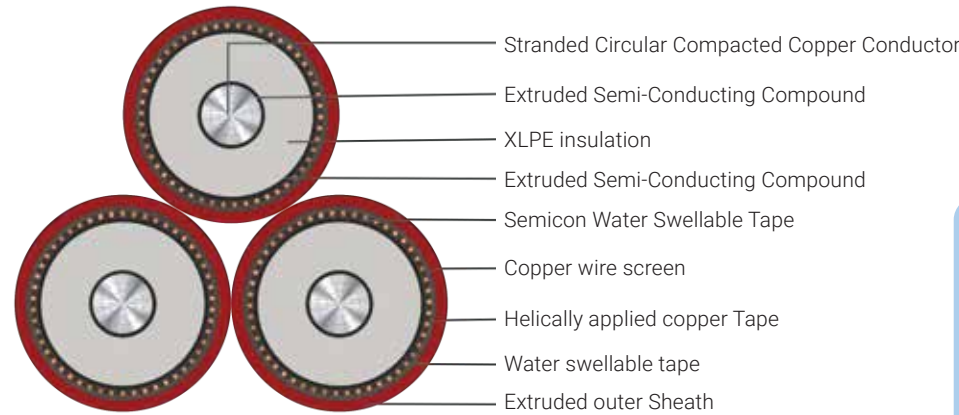

Outstanding Features

- Flame retardant
- High life
- UV resistant
- Oil resistant

Application

POLYCAB MV AL BS 7870-4-10 6.35/11 KV compacted aluminium conductor XLPE insulated, copper wire screened single core cable is designed for power networks, underground direct buried or in cable ducting.

Voltage Rating

Nominal Voltage: 6.35/11 (12) kV

Operation Temperature

Max. operating temperature: +90°C
Max. Short Circuit Temperature: 250°C

Construction

- Conductor: Circular Compacted aluminium conductor as per BS EN/IEC 60228, class 2
- Conductor Screen: Extruded Semi-conductive compound
- Insulation: XLPE as per BS 7870-1
- EPR can be provided on demand as per BS 7870-1
- Non-Metallic Insulation Screen: Extruded Semi-conductive compound (Bonded or Cold strippable)
- Separation tape: Semicon water swellable tape
- Metallic Insulation Screen: Copper wire & Copper tape screen
- Separation tape: Plain water swellable tape
- Outer Sheath: Extruded medium density polyethylene or Low smoke zero halogen compound as per BS 7870-1, Colour: Red

Standard and References:

BS EN/IEC 60228
BS 7870-1
BS 7870-4-10

Test Voltage

25.5kV AC

Impulse Test Voltage

Peak 95kV AC

Compliance

Conductor resistance BS EN/IEC 60228
Insulation resistance BS 7870-4-10
Flame Retardant test BS EN/IEC 60332-1-2
Partial Discharge test BS 7870-4-10
Smoke Emission test BS EN/IEC 61034-2



Bending Radius:

Fixed Installation: 20 x Overall diameter



POLYCAB MV AL BS 7870-4-10 6.35/11 KV Triplex
Medium Voltage Copper wire screened Cable, 6.35/11 (12) KV AC

Product code	No. of Cores	Nominal Cross sectional Area	Nominal area of metallic screen	Overall diameter (Approx.)	Weight (Approx.)
		mm ²	mm ²	mm	Kg/Km
MVBS22AXAWPM001C070S	3 x 1 (triplex)	70	35	53.4	2550
MVBS22AXAWPM001C095S	3 x 1 (triplex)	95	35	57.3	2850
MVBS22AXAWPM001C120S	3 x 1 (triplex)	120	35	60.3	3150
MVBS22AXAWPM001C150S	3 x 1 (triplex)	150	35	64.2	3600
MVBS22AXAWPM001C185S	3 x 1 (triplex)	185	35	67.4	3900
MVBS22AXAWPM001C240S	3 x 1 (triplex)	240	35	72.6	4650
MVBS22AXAWPM001C300S	3 x 1 (triplex)	300	35	78.0	5250
MVBS22AXAWPM001C400S	3 x 1 (triplex)	400	35	84.7	6300
MVBS22AXAWPM001C500S	3 x 1 (triplex)	500	35	91.6	7500
MVBS22AXAWPM001C630S	3 x 1 (triplex)	630	35	99.0	8850
MVBS22AXAWPM001C800S	3 x 1 (triplex)	800	35	114.3	10650
MVBS22AXAWPM001C01KS	3 x 1 (triplex)	1000	35	124	12750

Electrical Characteristics:

Nominal Cross Sectional Area	Max. DC Resistance at 20°C	Max. AC Resistance at 90°C	Short circuit current rating of conductor	Short circuit current rating of metallic screen	Capacitance (Approx.)	Inductance (Approx.)	Reactance (Approx.)
mm ²	Ω/km	Ω/km	kA/s	kA/s	μF/km	mH/km	Ω/km
70	0.443	0.565	6.61	4.5	0.28	0.38	0.12
95	0.320	0.408	8.98	4.5	0.31	0.36	0.11
120	0.253	0.323	11.34	4.5	0.34	0.35	0.11
150	0.206	0.263	14.17	4.5	0.37	0.34	0.11
185	0.164	0.210	17.48	4.5	0.40	0.33	0.10
240	0.125	0.161	22.68	4.5	0.45	0.31	0.10
300	0.100	0.129	28.35	4.5	0.50	0.30	0.10
400	0.0778	0.102	37.79	4.5	0.56	0.29	0.09
500	0.0605	0.080	47.24	4.5	0.62	0.23	0.07
630	0.0469	0.064	59.52	4.5	0.68	0.23	0.07
800	0.0367	0.053	75.59	4.5	0.82	0.21	0.07
1000	0.0291	0.044	94.48	4.5	0.91	0.21	0.07



POLYCAB MV AL BS 7870-4-10 6.35/11 KV Triplex
Medium Voltage Copper wire screened Cable, 6.35/11 (12) KV AC

Nominal cross sectional area mm ²	Continues Current Rating					
	Buried direct in the ground		In single-way ducts		In air	
	Trefoil Amp.	Flat spaced Amp.	Trefoil ducts Amp.	Flat touching Amp.	Trefoil Amp.	Flat touching Amp.
70	186	192	176	178	230	236
95	221	229	210	213	280	287
120	252	260	240	242	324	332
150	281	288	267	271	368	376
185	317	324	303	307	424	432
240	367	373	351	356	502	511
300	414	419	397	402	577	586
400	470	466	451	457	673	676
500	507	480	441	396	748	712
630	565	524	490	429	856	798
800	608	546	524	444	949	859
1000	655	575	560	465	1049	931

Maximum conductor temperature	90°C
Ambient air temperature	30°C
Ground temperature	20°C
Depth of laying	0.8 m
Thermal resistivity of soil	1.5 K.m/W
Thermal resistivity of earthenware ducts	1.2 K.m/W

Current rating de-rating factors for other than 30°C ambient air temperature.

Air Temperature	20	25	35	40	45	50	55	60
De-rating factor	1.08	1.04	0.96	0.91	0.87	0.82	0.76	0.71

Current rating de-rating factors for other than 20°C ground temperature.

Ground Temperature	10	15	25	30	35	40	45	50
De-rating factor	1.07	1.04	0.96	0.93	0.89	0.85	0.8	0.76

POLYCAB MV AL BS 7870-4-10 6.35/11 KV
Medium Voltage Copper wire screened Cable, 6.35/11 (12) KV AC

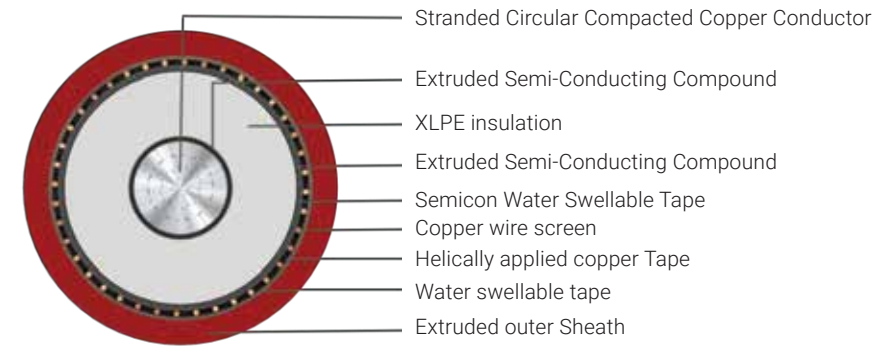

Outstanding Features

- Flame retardant
- High life
- UV resistant
- Oil resistant

Application

POLYCAB MV AL BS 7870-4-10 6.35/11 KV compacted aluminium conductor XLPE insulated, copper wire screened single core cable is designed to use for power networks underground direct buried or in cable ducting.

Voltage Rating

Nominal Voltage: 6.35/11 (12) kV

Operation Temperature

Max. operating temperature: +90°C
 Max. Short Circuit Temperature: 250°C

Construction

- Conductor: Circular Compacted aluminium conductor as per BS EN/IEC 60228, class 2
- Conductor Screen: Extruded Semi-conductive compound
- Insulation: XLPE as per BS 7870-1
- EPR can be provided on demand as per BS 7870-1
- Non-Metallic Insulation Screen: Extruded Semi-conductive compound (Bonded or Cold strippable)
- Separation tape: Semicon water swellable tape
- Metallic Insulation Screen: Copper wire & Copper tape screen
- Separation tape: Plain water swellable tape
- Outer Sheath: Extruded medium density polyethylene or Low smoke zero halogen compound as per BS 7870-1, Colour: Red

Bending Radius:

Fixed Installation: 20 x Overall diameter

Standard and References:

BS EN/IEC 60228
 BS 7870-1
 BS 7870-4-10

Test Voltage

25.5kV AC

Impulse Test Voltage

Peak 95kV AC

Compliance

Conductor resistance BS EN/IEC 60228
 Insulation resistance BS 7870-4-10
 Flame Retardant test BS EN/IEC 60332-1-2
 Partial Discharge test BS 7870-4-10
 Smoke Emission test BS EN/IEC 61034-2



OUR CERTIFICATION
 ISO 9001 | ISO 14001 | ISO 45001



OUR CERTIFICATION
 ISO 9001 | ISO 14001 | ISO 45001



POLYCAB MV AL BS 7870-4-10 6.35/11 KV
Medium Voltage Copper wire screened Cable, 6.35/11 (12) KV AC

Product code	No. of Cores	Nominal Cross sectional Area	Nominal area of metallic screen	Overall diameter (Approx.)	Weight (Approx.)
		mm ²	mm ²	mm	Kg/Km
MVBS22AXAWPM001C070S	1	70	35	24.7	850
MVBS22AXAWPM001C095S	1	95	35	26.5	950
MVBS22AXAWPM001C120S	1	120	35	27.9	1050
MVBS22AXAWPM001C150S	1	150	35	29.7	1200
MVBS22AXAWPM001C185S	1	185	35	31.2	1300
MVBS22AXAWPM001C240S	1	240	35	33.6	1550
MVBS22AXAWPM001C300S	1	300	35	36.1	1750
MVBS22AXAWPM001C400S	1	400	35	39.2	2100
MVBS22AXAWPM001C500S	1	500	35	42.4	2500
MVBS22AXAWPM001C630S	1	630	35	45.8	2950
MVBS22AXAWPM001C800S	1	800	35	52.9	3550
MVBS22AXAWPM001C01KS	1	1000	35	57.4	4250

Electrical Characteristics:

Nominal Cross Sectional Area mm ²	Max. DC Resistance at 20°C Ω/km	Max. AC Resistance at 90°C Ω/km	Short circuit current rating of conductor kA/s	Short circuit current rating of metallic screen kA/s	Capacitance (Approx.) μF/km	Inductance (Approx.) mH/km	Reactance (Approx.) Ω/km
70	0.443	0.565	6.61	4.5	0.28	0.38	0.12
95	0.320	0.408	8.98	4.5	0.31	0.36	0.11
120	0.253	0.323	11.34	4.5	0.34	0.35	0.11
150	0.206	0.263	14.17	4.5	0.37	0.34	0.11
185	0.164	0.210	17.48	4.5	0.40	0.33	0.10
240	0.125	0.161	22.68	4.5	0.45	0.31	0.10
300	0.100	0.129	28.35	4.5	0.50	0.30	0.10
400	0.0778	0.102	37.79	4.5	0.56	0.29	0.09
500	0.0605	0.080	47.24	4.5	0.62	0.23	0.07
630	0.0469	0.064	59.52	4.5	0.68	0.23	0.07
800	0.0367	0.053	75.59	4.5	0.82	0.21	0.07
1000	0.0291	0.044	94.48	4.5	0.91	0.21	0.07

POLYCAB MV AL BS 7870-4-10 6.35/11 KV
Medium Voltage Copper wire screened Cable, 6.35/11 (12) KV AC

Nominal cross sectional area mm ²	Continues Current Rating					
	Buried direct in the ground		In single-way ducts		In air	
	Trefoil Amp.	Flat spaced Amp.	Trefoil ducts Amp.	Flat touching Amp.	Trefoil Amp.	Flat touching Amp.
70	186	192	176	178	230	236
95	221	229	210	213	280	287
120	252	260	240	242	324	332
150	281	288	267	271	368	376
185	317	324	303	307	424	432
240	367	373	351	356	502	511
300	414	419	397	402	577	586
400	470	466	451	457	673	676
500	507	480	441	396	748	712
630	565	524	490	429	856	798
800	608	546	524	444	949	859
1000	655	575	560	465	1049	931

Maximum conductor temperature	90°C
Ambient air temperature	30°C
Ground temperature	20°C
Depth of laying	0.8 m
Thermal resistivity of soil	1.5 K.m/W
Thermal resistivity of earthenware ducts	1.2 K.m/W

Current rating de-rating factors for other than 30°C ambient air temperature.

Air Temperature	20	25	35	40	45	50	55	60
De-rating factor	1.08	1.04	0.96	0.91	0.87	0.82	0.76	0.71

Current rating de-rating factors for other than 20°C ground temperature.

Ground Temperature	10	15	25	30	35	40	45	50
De-rating factor	1.07	1.04	0.96	0.93	0.89	0.85	0.8	0.76



OUR CERTIFICATION
 ISO 9001 | ISO 14001 | ISO 45001



OUR CERTIFICATION
 ISO 9001 | ISO 14001 | ISO 45001



POLYCAB MV AL BS 7870-4-10 12.7/22 KV Triplex
Medium Voltage Copper wire screened Cable, 12.7/22 (24) KV AC

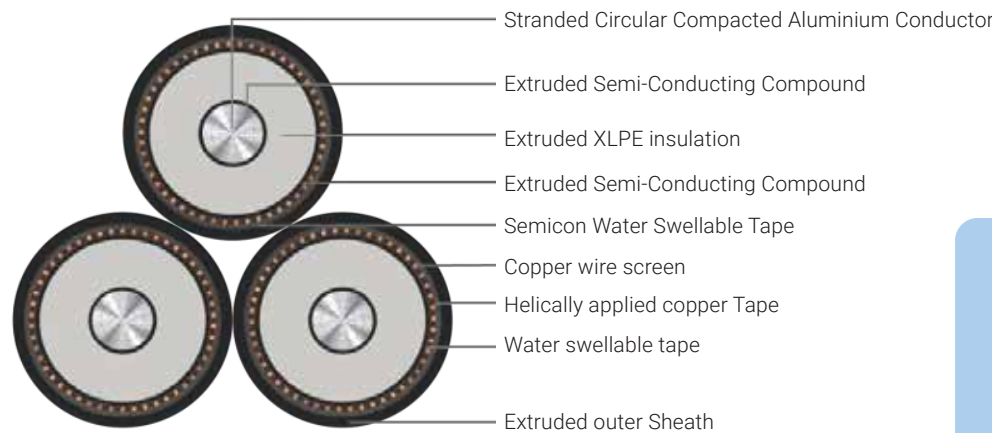

Outstanding Features

- Flame retardant
- High life
- UV resistant
- Oil resistant

Application

POLYCAB MV AL BS 7870-4-10 12.7/22 KV compacted aluminium conductor XLPE insulated, copper wire screened cable generally conforming to BS 7870-4-10. These cables are designed for power networks, underground direct buried or in cable ducting.

Voltage Rating

Nominal Voltage: 12.7/22 (24) kV

Operation Temperature

Max. operating temperature: +90°C
Max. Short Circuit Temperature: 250°C

Construction

- Conductor: Circular Compacted aluminium conductor as per BS EN/IEC 60228, class 2
- Conductor Screen: Extruded Semi-conductive compound
- Insulation: XLPE as per BS 7870-1
- EPR can be provided on demand as per BS 7870-1
- Non-Metallic Insulation Screen: Extruded Semi-conductive compound (Bonded or Cold strippable)
- Separation tape: Semicon water swellable tape
- Metallic Insulation Screen: Copper wire & Copper tape screen
- Separation tape: Plain water swellable tape
- Outer Sheath: Extruded medium density polyethylene or Low smoke zero halogen compound as per BS 7870-1, Colour: Black

Standard and References:

BS EN/IEC 60228
BS 7870-1
BS 7870-4-10

Test Voltage

51kV AC

Impulse Test Voltage

Peak 144kV AC

Compliance

Conductor resistance BS EN/IEC 60228
Insulation resistance BS 7870-4-10
Flame Retardant test BS EN/IEC 60332-1-2
Partial Discharge test BS 7870-4-10
Smoke Emission test BS EN/IEC 61034-2



Bending Radius:

Fixed Installation: 20 x Overall diameter



POLYCAB MV AL BS 7870-4-10 12.7/22 KV Triplex
Medium Voltage Copper wire screened Cable, 12.7/22 (24) KV AC

Product code	No. of Cores	Nominal Cross sectional Area	Nominal area of metallic screen	Overall diameter (Approx.)	Weight (Approx.)
		mm ²	mm ²	mm	Kg/Km
MVBS19AXAWPM001C070S	3 x 1 (triplex)	70	35	63.3	3150
MVBS19AXAWPM001C095S	3 x 1 (triplex)	95	35	66.8	3450
MVBS19AXAWPM001C120S	3 x 1 (triplex)	120	35	70.2	3900
MVBS19AXAWPM001C150S	3 x 1 (triplex)	150	35	73.7	4200
MVBS19AXAWPM001C185S	3 x 1 (triplex)	185	35	77.4	4650
MVBS19AXAWPM001C240S	3 x 1 (triplex)	240	35	82.6	5400
MVBS19AXAWPM001C300S	3 x 1 (triplex)	300	35	87.5	6150
MVBS19AXAWPM001C400S	3 x 1 (triplex)	400	35	94.2	7200
MVBS19AXAWPM001C500S	3 x 1 (triplex)	500	35	101.1	8400
MVBS19AXAWPM001C630S	3 x 1 (triplex)	630	35	108.5	9750
MVBS19AXAWPM001C800S	3 x 1 (triplex)	800	35	124.2	11850
MVBS19AXAWPM001C01KS	3 x 1 (triplex)	1000	35	134	13950

Electrical Characteristics:

Nominal Cross Sectional Area	Max. DC Resistance at 20°C	Max. AC Resistance at 90°C	Short circuit current rating of conductor	Short circuit current rating of metallic screen	Capacitance (Approx.)	Inductance (Approx.)	Reactance (Approx.)
mm ²	Ω/km	Ω/km	kA/s	kA/s	μF/km	mH/km	Ω/km
70	0.443	0.565	6.61	4.5	0.19	0.41	0.13
95	0.320	0.408	8.98	4.5	0.21	0.39	0.12
120	0.253	0.323	11.34	4.5	0.23	0.38	0.12
150	0.206	0.263	14.17	4.5	0.25	0.36	0.11
185	0.164	0.210	17.48	4.5	0.27	0.35	0.11
240	0.125	0.161	22.68	4.5	0.30	0.34	0.11
300	0.100	0.129	28.35	4.5	0.33	0.33	0.10
400	0.0778	0.101	37.79	4.5	0.37	0.31	0.10
500	0.0605	0.080	47.24	4.5	0.41	0.25	0.08
630	0.0469	0.064	59.52	4.5	0.45	0.24	0.08
800	0.0367	0.052	75.59	4.5	0.53	0.23	0.07
1000	0.0291	0.044	94.48	4.5	0.59	0.22	0.07



POLYCAB MV AL BS 7870-4-10 12.7/22 KV Triplex
Medium Voltage Copper wire screened Cable, 12.7/22 (24) KV AC

Current Carrying Capacity

Nominal cross sectional area mm ²	Continues Current Rating					
	Buried direct in the ground		In single-way ducts		In air	
	Trefoil Amp.	Flat spaced Amp.	Trefoil ducts Amp.	Flat touching Amp.	Trefoil Amp.	Flat touching Amp.
70	186	192	176	178	230	236
95	221	229	210	213	280	287
120	252	260	240	242	324	332
150	281	288	267	271	368	376
185	317	324	303	307	424	432
240	367	373	351	356	502	511
300	414	419	397	402	577	586
400	470	466	451	457	673	676
500	507	480	441	396	748	712
630	565	524	490	429	856	798
800	608	546	524	444	949	859
1000	655	575	560	465	1049	931

Maximum conductor temperature	90°C
Ambient air temperature	30°C
Ground temperature	20°C
Depth of laying	0.8 m
Thermal resistivity of soil	1.5 K.m/W
Thermal resistivity of earthenware ducts	1.2 K.m/W

Current rating de-rating factors for other than 30°C ambient air temperature.

Air Temperature	20	25	35	40	45	50	55	60
De-rating factor	1.08	1.04	0.96	0.91	0.87	0.82	0.76	0.71

Current rating de-rating factors for other than 20°C ground temperature.

Ground Temperature	10	15	25	30	35	40	45	50
De-rating factor	1.07	1.04	0.96	0.93	0.89	0.85	0.8	0.76

POLYCAB MV AL BS 7870-4-10 12.7/22 KV
Medium Voltage Copper wire screened Cable, 12.7/22 (24) KV AC

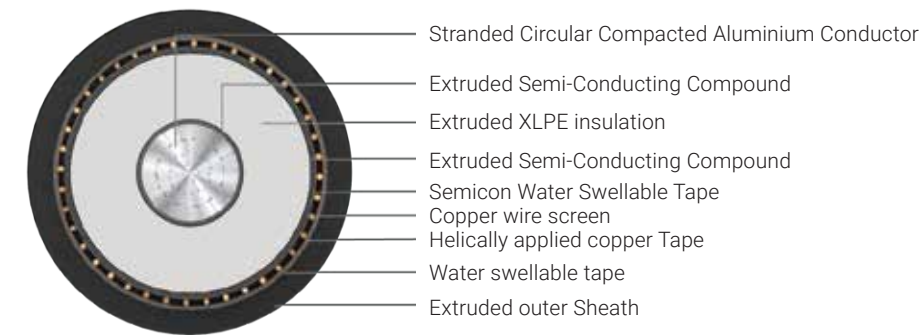

- Outstanding Features**
- Flame retardant
 - High life
 - UV resistant
 - Oil resistant

Application

POLYCAB MV AL BS 7870-4-10 12.7/22 KV compacted aluminium conductor XLPE insulated, copper wire screened single core cable is designed to use for power networks, underground direct buried or in cable ducting.

Voltage Rating

Nominal Voltage: 12.7/22 (24) kV

Operation Temperature

Max. operating temperature: +90°C
 Max. Short Circuit Temperature: 250°C

Construction

- Conductor: Circular Compacted aluminium conductor as per BS EN/IEC 60228, class 2
- Conductor Screen: Extruded Semi-conductive compound
- Insulation: XLPE as per BS 7870-1
- EPR can be provided on demand as per BS 7870-1
- Non-Metallic Insulation Screen: Extruded Semi-conductive compound (Bonded or Cold strippable)
- Separation tape: Semicon water swellable tape
- Metallic Insulation Screen: Copper wire & Copper tape screen
- Separation tape: Plain water swellable tape
- Outer Sheath: Extruded medium density polyethylene or Low smoke zero halogen compound as per BS 7870-1, Colour: Black

Bending Radius:

Fixed Installation: 20 x Overall diameter

Standard and References:

BS EN/IEC 60228
 BS 7870-1
 BS 7870-4-10

Test Voltage

51kV AC

Impulse Test Voltage

Peak 144kV AC

Compliance

Conductor resistance BS EN/IEC 60228
 Insulation resistance BS 7870-4-10
 Flame Retardant test BS EN/IEC 60332-1-2
 Partial Discharge test BS 7870-4-10
 Smoke Emission test BS EN/IEC 61034-2



OUR CERTIFICATION
 ISO 9001 | ISO 14001 | ISO 45001



OUR CERTIFICATION
 ISO 9001 | ISO 14001 | ISO 45001



POLYCAB MV AL BS 7870-4-10 12.7/22 KV
Medium Voltage Copper wire screened Cable, 12.7/22 (24) KV AC

Product code	No. of Cores	Nominal Cross sectional Area	Nominal area of metallic screen	Overall diameter (Approx.)	Weight (Approx.)
		mm ²	mm ²	mm	Kg/Km
MVBS19AXAWPM001C070S	1	70	35	29.3	1050
MVBS19AXAWPM001C095S	1	95	35	30.9	1150
MVBS19AXAWPM001C120S	1	120	35	32.5	1300
MVBS19AXAWPM001C150S	1	150	35	34.1	1400
MVBS19AXAWPM001C185S	1	185	35	35.8	1550
MVBS19AXAWPM001C240S	1	240	35	38.2	1800
MVBS19AXAWPM001C300S	1	300	35	40.5	2050
MVBS19AXAWPM001C400S	1	400	35	43.6	2400
MVBS19AXAWPM001C500S	1	500	35	46.8	2800
MVBS19AXAWPM001C630S	1	630	35	50.2	3250
MVBS19AXAWPM001C800S	1	800 3	5	57.5	3950
MVBS19AXAWPM001C01KS	1	1000	35	62.0	4650

Electrical Characteristics:

Nominal Cross Sectional Area mm ²	Max. DC Resistance at 20°C Ω/km	Max. AC Resistance at 90°C Ω/km	Short circuit current rating of conductor kA/s	Short circuit current rating of metallic screen kA/s	Capacitance (Approx.) μF/km	Inductance (Approx.) mH/km	Reactance (Approx.) Ω/km
70	0.443	0.565	6.61	4.5	0.19	0.41	0.13
95	0.320	0.408	8.98	4.5	0.21	0.39	0.12
120	0.253	0.323	11.34	4.5	0.23	0.38	0.12
150	0.206	0.263	14.17	4.5	0.25	0.36	0.11
185	0.164	0.210	17.48	4.5	0.27	0.35	0.11
240	0.125	0.161	22.68	4.5	0.30	0.34	0.11
300	0.100	0.129	28.35	4.5	0.33	0.33	0.10
400	0.0778	0.101	37.79	4.5	0.37	0.31	0.10
500	0.0605	0.080	47.24	4.5	0.41	0.25	0.08
630	0.0469	0.064	59.52	4.5	0.45	0.24	0.08
800	0.0367	0.052	75.59	4.5	0.53	0.23	0.07
1000	0.0291	0.044	94.48	4.5	0.59	0.22	0.07

POLYCAB MV AL BS 7870-4-10 12.7/22 KV
Medium Voltage Copper wire screened Cable, 12.7/22 (24) KV AC

Current Carrying Capacity

Nominal cross sectional area mm ²	Continues Current Rating					
	Buried direct in the ground		In single-way ducts		In air	
	Trefoil Amp.	Flat spaced Amp.	Trefoil ducts Amp.	Flat touching Amp.	Trefoil Amp.	Flat touching Amp.
70	186	192	176	178	230	236
95	221	229	210	213	280	287
120	252	260	240	242	324	332
150	281	288	267	271	368	376
185	317	324	303	307	424	432
240	367	373	351	356	502	511
300	414	419	397	402	577	586
400	470	466	451	457	673	676
500	507	480	441	396	748	712
630	565	524	490	429	856	798
800	608	546	524	444	949	859
1000	655	575	560	465	1049	931

Maximum conductor temperature	90°C
Ambient air temperature	30°C
Ground temperature	20°C
Depth of laying	0.8 m
Thermal resistivity of soil	1.5 K.m/W
Thermal resistivity of earthenware ducts	1.2 K.m/W

Current rating de-rating factors for other than 30°C ambient air temperature.

Air Temperature	20	25	35	40	45	50	55	60
De-rating factor	1.08	1.04	0.96	0.91	0.87	0.82	0.76	0.71

Current rating de-rating factors for other than 20°C ground temperature.

Ground Temperature	10	15	25	30	35	40	45	50
De-rating factor	1.07	1.04	0.96	0.93	0.89	0.85	0.8	0.76



OUR CERTIFICATION
 ISO 9001 | ISO 14001 | ISO 45001



OUR CERTIFICATION
 ISO 9001 | ISO 14001 | ISO 45001



POLYCAB MV AL BS 7870-4-10 19/33 KV Triplex
Medium Voltage Copper wire screened Cable, 19/33 (36) KV AC

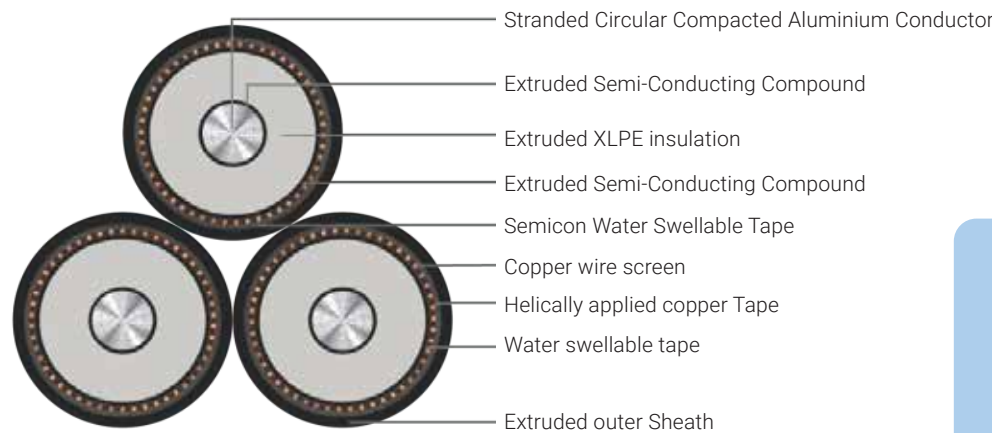

Outstanding Features

- Flame retardant
- High life
- UV resistant
- Oil resistant

Application

POLYCAB MV AL BS 7870-4-10 19/33 KV compacted aluminium conductor XLPE insulated, copper wire screened cable generally conforming to BS 7870-4-10. These cables are designed for power networks, underground direct buried or in cable ducting.

Voltage Rating

Nominal Voltage: 12.7/22 (24) kV

Operation Temperature

Max. operating temperature: +90°C
Max. Short Circuit Temperature: 250°C

Construction

- Conductor: Circular Compacted aluminium conductor as per BS EN/IEC 60228, class 2
- Conductor Screen: Extruded Semi-conductive compound
- Insulation: XLPE as per BS 7870-1
- EPR can be provided on demand as per BS 7870-1
- Non-Metallic Insulation Screen: Extruded Semi-conductive compound (Bonded or Cold strippable)
- Separation tape: Semicon water swellable tape
- Metallic Insulation Screen: Copper wire & Copper tape screen
- Separation tape: Plain water swellable tape
- Outer Sheath: Extruded medium density polyethylene or Low smoke zero halogen compound as per BS 7870-1, Colour: Black

Standard and References:

BS EN/IEC 60228
BS 7870-1
BS 7870-4-10

Test Voltage

76kV AC

Impulse Test Voltage

Peak 194kV AC

Compliance

Conductor resistance BS EN/IEC 60228
Insulation resistance BS 7870-4-10
Flame Retardant test BS EN/IEC 60332-1-2
Partial Discharge test BS 7870-4-10
Smoke Emission test BS EN/IEC 61034-2



Bending Radius:

Fixed Installation: 20 x Overall diameter



OUR CERTIFICATION
ISO 9001 | ISO 14001 | ISO 45001



POLYCAB MV AL BS 7870-4-10 19/33 KV Triplex
Medium Voltage Copper wire screened Cable, 19/33 (36) KV AC

Product code	No. of Cores	Nominal Cross sectional Area	Nominal area of metallic screen	Overall diameter (Approx.)	Weight (Approx.)
		mm ²	mm ²	mm	Kg/Km
MVBS20AXAWPM001C070S	3 x 1 (triplex)	70	35	34.5	1200
MVBS20AXAWPM001C095S	3 x 1 (triplex)	95	35	36.3	1350
MVBS20AXAWPM001C120S	3 x 1 (triplex)	120	35	37.7	1500
MVBS20AXAWPM001C150S	3 x 1 (triplex)	150	35	39.5	1600
MVBS20AXAWPM001C185S	3 x 1 (triplex)	185	35	41.0	1850
MVBS20AXAWPM001C240S	3 x 1 (triplex)	240	35	43.4	2100
MVBS20AXAWPM001C300S	3 x 1 (triplex)	300	35	45.9	2400
MVBS20AXAWPM001C400S	3 x 1 (triplex)	400	35	49.0	2750
MVBS20AXAWPM001C500S	3 x 1 (triplex)	500	35	52.2	3200
MVBS20AXAWPM001C630S	3 x 1 (triplex)	630	35	55.6	3700
MVBS20AXAWPM001C800S	3 x 1 (triplex)	800	35	62.7	4450
MVBS20AXAWPM001C01KS	3 x 1 (triplex)	1000	35	67.4	5200

Electrical Characteristics:

Nominal Cross Sectional Area	Max. DC Resistance at 20°C	Max. AC Resistance at 90°C	Short circuit current rating of conductor	Short circuit current rating of metallic screen	Capacitance (Approx.)	Inductance (Approx.)	Reactance (Approx.)
mm ²	Ω/km	Ω/km	kA/s	kA/s	μF/km	mH/km	Ω/km
70	0.443	0.565	6.61	4.5	0.15	0.45	0.14
95	0.320	0.408	8.98	4.5	0.16	0.43	0.13
120	0.253	0.323	11.34	4.5	0.18	0.41	0.13
150	0.206	0.263	14.17	4.5	0.19	0.39	0.12
185	0.164	0.210	17.48	4.5	0.20	0.38	0.12
240	0.125	0.161	22.68	4.5	0.23	0.36	0.11
300	0.100	0.129	28.35	4.5	0.25	0.35	0.11
400	0.0778	0.101	37.79	4.5	0.27	0.34	0.11
500	0.0605	0.080	47.24	4.5	0.30	0.28	0.09
630	0.0469	0.063	59.52	4.5	0.33	0.27	0.08
800	0.0367	0.052	75.59	4.5	0.39	0.25	0.08
1000	0.0291	0.043	94.48	4.5	0.42	0.24	0.08



OUR CERTIFICATION
ISO 9001 | ISO 14001 | ISO 45001



POLYCAB MV AL BS 7870-4-10 19/33 KV Triplex
Medium Voltage Copper wire screened Cable, 19/33 (36) KV AC

Current Carrying Capacity

Nominal cross sectional area mm ²	Continues Current Rating					
	Buried direct in the ground		In single-way ducts		In air	
	Trefoil Amp.	Flat spaced Amp.	Trefoil ducts Amp.	Flat touching Amp.	Trefoil Amp.	Flat touching Amp.
70	186	192	176	178	230	236
95	221	229	210	213	280	287
120	252	260	240	242	324	332
150	281	288	267	271	368	376
185	317	324	303	307	424	432
240	367	373	351	356	502	511
300	414	419	397	402	577	586
400	470	466	451	457	673	676
500	507	480	441	396	748	712
630	565	524	490	429	856	798
800	608	546	524	444	949	859
1000	655	575	560	465	1049	931

Maximum conductor temperature	90°C
Ambient air temperature	30°C
Ground temperature	20°C
Depth of laying	0.8 m
Thermal resistivity of soil	1.5 K.m/W
Thermal resistivity of earthenware ducts	1.2 K.m/W

Current rating de-rating factors for other than 30°C ambient air temperature.

Air Temperature	20	25	35	40	45	50	55	60
De-rating factor	1.08	1.04	0.96	0.91	0.87	0.82	0.76	0.71

Current rating de-rating factors for other than 20°C ground temperature.

Ground Temperature	10	15	25	30	35	40	45	50
De-rating factor	1.07	1.04	0.96	0.93	0.89	0.85	0.8	0.76

POLYCAB MV AL BS 7870-4-10 19/33 KV
Medium Voltage Copper wire screened Cable, 19/33 (36) KV AC

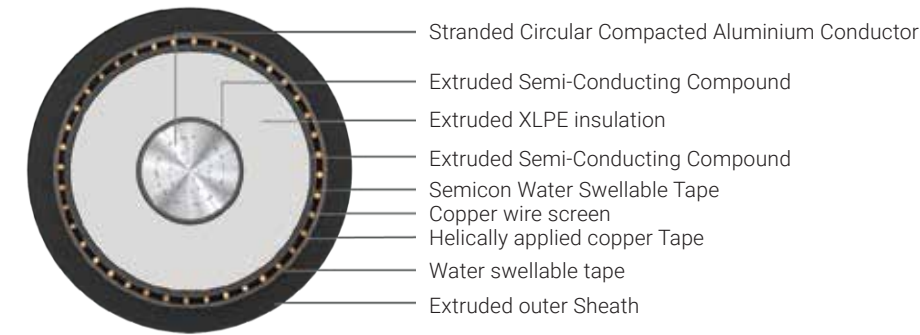

- Outstanding Features**
- Flame retardant
 - High life
 - UV resistant
 - Oil resistant

Application

POLYCAB MV AL BS 7870-4-10 19/33 KV compacted aluminium conductor XLPE insulated, copper wire screened single core cable is designed to use for power networks, underground direct buried or in cable ducting.

Voltage Rating

Nominal Voltage: 19/33 (36) kV

Operation Temperature

Max. operating temperature: +90°C
 Max. Short Circuit Temperature: 250°C

Construction

- Conductor: Circular Compacted aluminium conductor as per BS EN/IEC 60228, class 2
- Conductor Screen: Extruded Semi-conductive compound
- Insulation: XLPE as per BS 7870-1
- EPR can be provided on demand as per BS 7870-1
- Non-Metallic Insulation Screen: Extruded Semi-conductive compound (Bonded or Cold strippable)
- Separation tape: Semicon water swellable tape
- Metallic Insulation Screen: Copper wire & Copper tape screen
- Separation tape: Plain water swellable tape
- Outer Sheath: Extruded medium density polyethylene or Low smoke zero halogen compound as per BS 7870-1, Colour: Black

Bending Radius:

Fixed Installation: 20 x Overall diameter

Standard and References:

BS EN/IEC 60228
 BS 7870-1
 BS 7870-4-10

Test Voltage

76kV AC

Impulse Test Voltage

Peak 194kV AC

Compliance

Conductor resistance	BS EN/IEC 60228
Insulation resistance	BS 7870-4-10
Flame Retardant test	BS EN/IEC 60332-1-2
Partial Discharge test	BS 7870-4-10
Smoke Emission test	BS EN/IEC 61034-2



OUR CERTIFICATION
 ISO 9001 | ISO 14001 | ISO 45001



OUR CERTIFICATION
 ISO 9001 | ISO 14001 | ISO 45001



POLYCAB MV AL BS 7870-4-10 19/33 KV
Medium Voltage Copper wire screened Cable, 19/33 (36) KV AC

Product code	No. of Cores	Nominal Cross sectional Area	Nominal area of metallic screen	Overall diameter (Approx.)	Weight (Approx.)
		mm ²	mm ²	mm	Kg/Km
MVBS20AXAWPM001C070S	1	70	35	34.5	1200
MVBS20AXAWPM001C095S	1	95	35	36.3	1350
MVBS20AXAWPM001C120S	1	120	35	37.7	1500
MVBS20AXAWPM001C150S	1	150	35	39.5	1600
MVBS20AXAWPM001C185S	1	185	35	41.0	1850
MVBS20AXAWPM001C240S	1	240	35	43.4	2100
MVBS20AXAWPM001C300S	1	300	35	45.9	2400
MVBS20AXAWPM001C400S	1	400	35	49.0	2750
MVBS20AXAWPM001C500S	1	500	35	52.2	3200
MVBS20AXAWPM001C630S	1	630	35	55.6	3700
MVBS20AXAWPM001C800S	1	800	35	62.7	4450
MVBS20AXAWPM001C01KS	1	1000	35	67.4	5200

Electrical Characteristics:

Nominal Cross Sectional Area mm ²	Max. DC Resistance at 20°C Ω/km	Max. AC Resistance at 90°C Ω/km	Short circuit current rating of conductor kA/s	Short circuit current rating of metallic screen kA/s	Capacitance (Approx.) μF/km	Inductance (Approx.) mH/km	Reactance (Approx.) Ω/km
70	0.443	0.565	6.61	4.5	0.15	0.45	0.14
95	0.320	0.408	8.98	4.5	0.16	0.43	0.13
120	0.253	0.323	11.34	4.5	0.18	0.41	0.13
150	0.206	0.263	14.17	4.5	0.19	0.39	0.12
185	0.164	0.210	17.48	4.5	0.20	0.38	0.12
240	0.125	0.161	22.68	4.5	0.23	0.36	0.11
300	0.100	0.129	28.35	4.5	0.25	0.35	0.11
400	0.0778	0.101	37.79	4.5	0.27	0.34	0.11
500	0.0605	0.080	47.24	4.5	0.30	0.28	0.09
630	0.0469	0.063	59.52	4.5	0.33	0.27	0.08
800	0.0367	0.052	75.59	4.5	0.39	0.25	0.08
1000	0.0291	0.043	94.48	4.5	0.42	0.24	0.08

POLYCAB MV AL BS 7870-4-10 19/33 KV
Medium Voltage Copper wire screened Cable, 19/33 (36) KV AC

Nominal cross sectional area mm ²	Continues Current Rating					
	Buried direct in the ground		In single-way ducts		In air	
	Trefoil Amp.	Flat spaced Amp.	Trefoil ducts Amp.	Flat touching Amp.	Trefoil Amp.	Flat touching Amp.
70	186	192	176	178	230	236
95	221	229	210	213	280	287
120	252	260	240	242	324	332
150	281	288	267	271	368	376
185	317	324	303	307	424	432
240	367	373	351	356	502	511
300	414	419	397	402	577	586
400	470	466	451	457	673	676
500	507	480	441	396	748	712
630	565	524	490	429	856	798
800	608	546	524	444	949	859
1000	655	575	560	465	1049	931

Maximum conductor temperature	90°C
Ambient air temperature	30°C
Ground temperature	20°C
Depth of laying	0.8 m
Thermal resistivity of soil	1.5 K.m/W
Thermal resistivity of earthenware ducts	1.2 K.m/W

Current rating de-rating factors for other than 30°C ambient air temperature.

Air Temperature	20	25	35	40	45	50	55	60
De-rating factor	1.08	1.04	0.96	0.91	0.87	0.82	0.76	0.71

Current rating de-rating factors for other than 20°C ground temperature.

Ground Temperature	10	15	25	30	35	40	45	50
De-rating factor	1.07	1.04	0.96	0.93	0.89	0.85	0.8	0.76



OUR CERTIFICATION
 ISO 9001 | ISO 14001 | ISO 45001



OUR CERTIFICATION
 ISO 9001 | ISO 14001 | ISO 45001



POLYCAB MV CU BS 7870-4-10 6.35/11 KV Triplex
Medium Voltage Copper wire screened Cable, 6.35/11 (12) KV AC

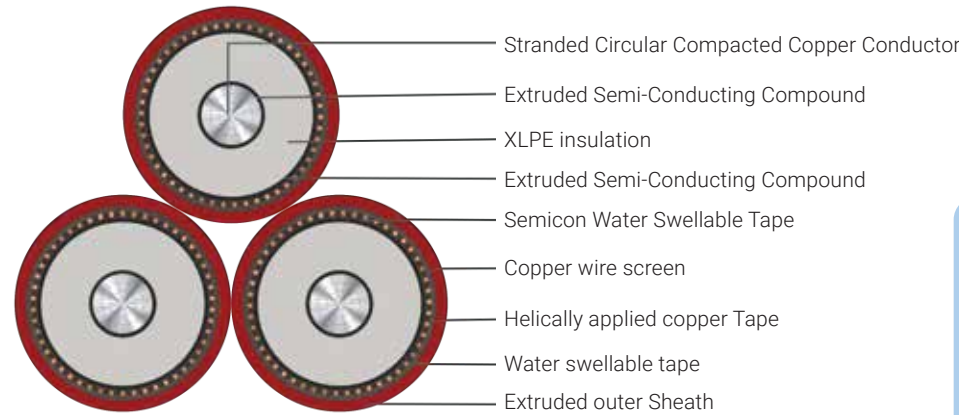

Outstanding Features

- Flame retardant
- High life
- UV resistant
- Oil resistant

Application

POLYCAB MV CU BS 7870-4-10 6.35/11 KV compacted copper conductor XLPE insulated, copper wire screened single core cable is designed for power networks, underground direct buried or in cable ducting.

Voltage Rating

Nominal Voltage: 6.35/11 (12) kV

Operation Temperature

Max. operating temperature: +90°C
Max. Short Circuit Temperature: 250°C

Construction

- Conductor: Circular Compacted aluminium conductor as per BS EN/IEC 60228, class 2
- Conductor Screen: Extruded Semi-conductive compound
- Insulation: XLPE as per BS 7870-1
- EPR can be provided on demand as per BS 7870-1
- Non-Metallic Insulation Screen: Extruded Semi-conductive compound (Bonded or Cold strippable)
- Separation tape: Semicon water swellable tape
- Metallic Insulation Screen: Copper wire & Copper tape screen
- Separation tape: Plain water swellable tape
- Outer Sheath: Extruded medium density polyethylene or Low smoke zero halogen compound as per BS 7870-1, Colour: Red

Standard and References:

BS EN/IEC 60228
BS 7870-1
BS 7870-4-10

Test Voltage

25.5kV AC

Impulse Test Voltage

Peak 95kV AC

Compliance

Conductor resistance BS EN/IEC 60228
Insulation resistance BS 7870-4-10
Flame Retardant test BS EN/IEC 60332-1-2
Partial Discharge test BS 7870-4-10
Smoke Emission test BS EN/IEC 61034-2



OUR CERTIFICATION
ISO 9001 | ISO 14001 | ISO 45001



POLYCAB MV CU BS 7870-4-10 6.35/11 KV Triplex
Medium Voltage Copper wire screened Cable, 6.35/11 (12) KV AC

Product code	No. of Cores	Nominal Cross sectional Area	Nominal area of metallic screen	Overall diameter (Approx.)	Weight (Approx.)
		mm ²	mm ²	mm	Kg/Km
MVBS22CXAWPM001C070S	3 x 1 (triplex)	70	35	53.4	3900
MVBS22CXAWPM001C095S	3 x 1 (triplex)	95	35	57.3	4650
MVBS22CXAWPM001C120S	3 x 1 (triplex)	120	35	60.3	5400
MVBS22CXAWPM001C150S	3 x 1 (triplex)	150	35	64.2	6450
MVBS22CXAWPM001C185S	3 x 1 (triplex)	185	35	67.4	7500
MVBS22CXAWPM001C240S	3 x 1 (triplex)	240	35	72.6	9150
MVBS22CXAWPM001C300S	3 x 1 (triplex)	300	35	78.0	11100
MVBS22CXAWPM001C400S	3 x 1 (triplex)	400	35	84.7	13800
MVBS22CXAWPM001C500S	3 x 1 (triplex)	500	35	91.6	17100
MVBS22CXAWPM001C630S	3 x 1 (triplex)	630	35	99.0	20850
MVBS22CXAWPM001C800S	3 x 1 (triplex)	800	35	114.3	25800
MVBS22CXAWPM001C01KS	3 x 1 (triplex)	1000	35	124	31650

Electrical Characteristics:

Nominal Cross Sectional Area mm ²	Max. DC Resistance at 20°C Ω/km	Max. AC Resistance at 90°C Ω/km	Short circuit current rating of conductor kA/s	Short circuit current rating of metallic screen kA/s	Capacitance (Approx.) µF/km	Inductance (Approx.) mH/km	Reactance (Approx.) Ω/km
70	0.268	0.342	10.02	4.5	0.28	0.38	0.12
95	0.193	0.247	13.59	4.5	0.31	0.36	0.11
120	0.153	0.196	17.17	4.5	0.34	0.35	0.11
150	0.124	0.159	21.46	4.5	0.37	0.34	0.11
185	0.0991	0.128	26.47	4.5	0.40	0.33	0.10
240	0.0754	0.098	34.34	4.5	0.45	0.31	0.10
300	0.0601	0.080	42.93	4.5	0.50	0.30	0.10
400	0.047	0.064	57.23	4.5	0.56	0.29	0.09
500	0.0366	0.052	71.54	4.5	0.62	0.23	0.07
630	0.0283	0.043	90.14	4.5	0.68	0.23	0.07
800	0.0221	0.037	114.47	4.5	0.82	0.21	0.07
1000	0.0176	0.033	143.	08	4.5	0.91	0.21



OUR CERTIFICATION
ISO 9001 | ISO 14001 | ISO 45001



POLYCAB MV CU BS 7870-4-10 6.35/11 KV Triplex
Medium Voltage Copper wire screened Cable, 6.35/11 (12) KV AC

Current Carrying Capacity

No. of core	Nominal cross sectional area mm ²	Ground at 20°C					
		In single-way ducts				In air	
		Trefoil Amp.	Flat spaced Amp.	Trefoil ducts Amp.	Flat Touchng Amp.	Trefoil Amp.	Flat Touchng Amp.
1	70	239	246	227	229	296	303
1	95	285	293	271	274	361	369
1	120	323	332	308	311	417	426
1	150	361	366	343	347	473	481
1	185	406	410	387	391	543	550
1	240	469	470	447	453	641	647
1	300	526	524	504	510	735	739
1	400	590	572	564	571	845	837
1	500	615	561	535	462	911	837
1	630	672	598	582	491	1023	919
1	800	703	605	605	493	1103	960
1	1000	739	626	633	506	1191	1020

Maximum conductor temperature	90°C
Ambient air temperature	30°C
Ground temperature	20°C
Depth of laying	0.8 m
Thermal resistivity of soil	1.5 K.m/W
Thermal resistivity of earthenware ducts	1.2 K.m/W

Current rating de-rating factors for other than 30°C ambient air temperature.

Air Temperature	20	25	35	40	45	50	55	60
De-rating factor	1.08	1.04	0.96	0.91	0.87	0.82	0.76	0.71

Current rating de-rating factors for other than 20°C ground temperature.

Ground Temperature	10	15	25	30	35	40	45	50
De-rating factor	1.07	1.04	0.96	0.93	0.89	0.85	0.8	0.76

POLYCAB MV CU BS 7870-4-10 6.35/11 KV
Medium Voltage Copper wire screened Cable, 6.35/11 (12) KV AC

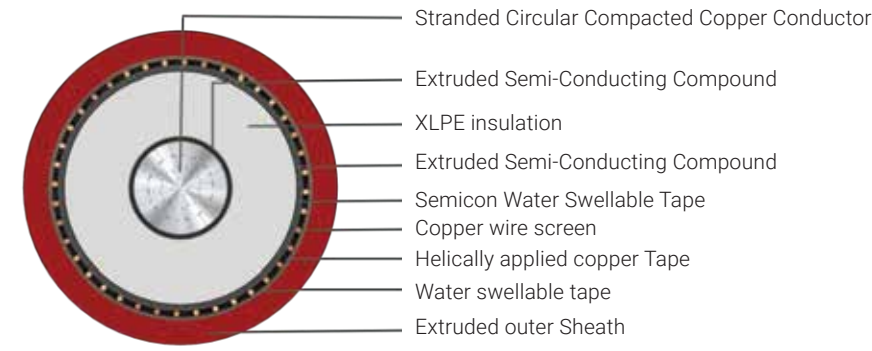

- Outstanding Features**
- Flame retardant
 - High life
 - UV resistant
 - Oil resistant

Application

POLYCAB MV CU BS 7870-4-10 6.35/11 KV compacted copper conductor XLPE insulated, copper wire screened single core cable is designed to use for power networks, underground direct buried or in cable ducting.

Voltage Rating

Nominal Voltage: 6.35/11 (12) kV

Operation Temperature

Max. operating temperature: +90°C
 Max. Short Circuit Temperature: 250°C

Construction

- Conductor: Circular Compacted aluminium conductor as per BS EN/IEC 60228, class 2
- Conductor Screen: Extruded Semi-conductive compound
- Insulation: XLPE as per BS 7870-1
- EPR can be provided on demand as per BS 7870-1
- Non-Metallic Insulation Screen: Extruded Semi-conductive compound (Bonded or Cold strippable)
- Separation tape: Semicon water swellable tape
- Metallic Insulation Screen: Copper wire & Copper tape screen
- Separation tape: Plain water swellable tape
- Outer Sheath: Extruded medium density polyethylene or Low smoke zero halogen compound as per BS 7870-1, Colour: Red

Bending Radius:

Fixed Installation: 20 x Overall diameter

Standard and References:

BS EN/IEC 60228
 BS 7870-1
 BS 7870-4-10

Test Voltage

25.5kV AC

Impulse Test Voltage

Peak 95kV AC

Compliance

Conductor resistance	BS EN/IEC 60228
Insulation resistance	BS 7870-4-10
Flame Retardant test	BS EN/IEC 60332-1-2
Partial Discharge test	BS 7870-4-10
Smoke Emission test	BS EN/IEC 61034-2



OUR CERTIFICATION
 ISO 9001 | ISO 14001 | ISO 45001



OUR CERTIFICATION
 ISO 9001 | ISO 14001 | ISO 45001



POLYCAB MV CU BS 7870-4-10 6.35/11 KV
Medium Voltage Copper wire screened Cable, 6.35/11 (12) KV AC

Product code	No. of Cores	Nominal Cross sectional Area	Nominal area of metallic screen	Overall diameter (Approx.)	Weight (Approx.)
		mm ²	mm ²	mm	Kg/Km
MVBS22CXAWPM001C070S	1	70	35	24.7	1300
MVBS22CXAWPM001C095S	1	95	35	26.5	1550
MVBS22CXAWPM001C120S	1	120	35	27.9	1800
MVBS22CXAWPM001C150S	1	150	35	29.7	2150
MVBS22CXAWPM001C185S	1	185	35	31.2	2500
MVBS22CXAWPM001C240S	1	240	35	33.6	3050
MVBS22CXAWPM001C300S	1	300	35	36.1	3700
MVBS22CXAWPM001C400S	1	400	35	39.2	4600
MVBS22CXAWPM001C500S	1	500	35	42.4	5700
MVBS22CXAWPM001C630S	1	630	35	45.8	6950
MVBS22CXAWPM001C800S	1	800	35	52.9	8600
MVBS22CXAWPM001C01KS	1	1000	35	57.4	10550

Electrical Characteristics:

Nominal Cross Sectional Area mm ²	Max. DC Resistance at 20°C Ω/km	Max. AC Resistance at 90°C Ω/km	Short circuit current rating of conductor kA/s	Short circuit current rating of metallic screen kA/s	Capacitance (Approx.) μF/km	Inductance (Approx.) mH/km	Reactance (Approx.) Ω/km
70	0.268	0.342	10.02	4.5	0.28	0.38	0.12
95	0.193	0.247	13.59	4.5	0.31	0.36	0.11
120	0.153	0.196	17.17	4.5	0.34	0.35	0.11
150	0.124	0.159	21.46	4.5	0.37	0.34	0.11
185	0.0991	0.128	26.47	4.5	0.40	0.33	0.10
240	0.0754	0.098	34.34	4.5	0.45	0.31	0.10
300	0.0601	0.080	42.93	4.5	0.50	0.30	0.10
400	0.047	0.064	57.23	4.5	0.56	0.29	0.09
500	0.0366	0.052	71.54	4.5	0.62	0.23	0.07
630	0.0283	0.043	90.14	4.5	0.68	0.23	0.07
800	0.0221	0.037	114.47	4.5	0.82	0.21	0.07
1000	0.0176	0.033	143.08	4.5	0.91	0.21	0.07



OUR CERTIFICATION
ISO 9001 | ISO 14001 | ISO 45001



POLYCAB MV CU BS 7870-4-10 6.35/11 KV
Medium Voltage Copper wire screened Cable, 6.35/11 (12) KV AC

Current Carrying Capacity

No. of core	Nominal cross sectional area mm ²	Ground at 20°C		In single-way ducts		In air	
		Trefoil	Flat spaced	Trefoil ducts	Flat Touchng	Trefoil	Flat Touchng
		Amp.	Amp.	Amp.	Amp.	Amp.	Amp.
1	70	239	246	227	229	296	303
1	95	285	293	271	274	361	369
1	120	323	332	308	311	417	426
1	150	361	366	343	347	473	481
1	185	406	410	387	391	543	550
1	240	469	470	447	453	641	647
1	300	526	524	504	510	735	739
1	400	590	572	564	571	845	837
1	500	615	561	535	462	911	837
1	630	672	598	582	491	1023	919
1	800	703	605	605	493	1103	960
1	1000	739	626	633	506	1191	1020

Maximum conductor temperature 90°C
 Ambient air temperature 30°C
 Ground temperature 20°C
 Depth of laying 0.8 m
 Thermal resistivity of soil 1.5 K.m/W
 Thermal resistivity of earthenware ducts 1.2 K.m/W

Current rating de-rating factors for other than 30°C ambient air temperature.

Air Temperature	20	25	35	40	45	50	55	60
De-rating factor	1.08	1.04	0.96	0.91	0.87	0.82	0.76	0.71

Current rating de-rating factors for other than 20°C ground temperature.

Ground Temperature	10	15	25	30	35	40	45	50
De-rating factor	1.07	1.04	0.96	0.93	0.89	0.85	0.8	0.76



OUR CERTIFICATION
ISO 9001 | ISO 14001 | ISO 45001



POLYCAB MV CU BS 7870-4-10 12.7/22 KV Triplex
Medium Voltage Copper wire screened Cable, 12.7/22 (24) KV AC

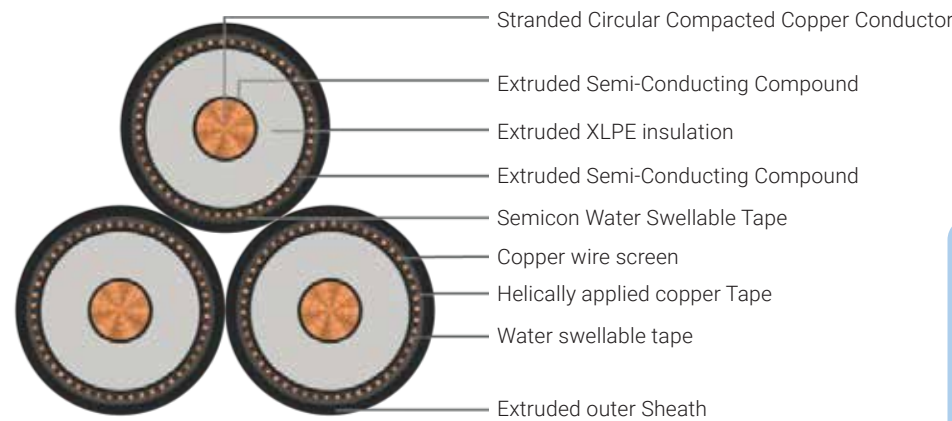

Outstanding Features

- Flame retardant
- High life
- UV resistant
- Oil resistant

Application

POLYCAB MV CU BS 7870-4-10 12.7/22 KV compacted copper conductor XLPE insulated, copper wire screened cable generally conforming to BS 7870-4-10. These cables are designed for power networks, underground direct buried or in cable ducting.

Voltage Rating

Nominal Voltage: 12.7/22 (24) kV

Operation Temperature

Max. operating temperature: +90°C
Max. Short Circuit Temperature: 250°C

Construction

- Conductor: Circular Compacted aluminium conductor as per BS EN/IEC 60228, class 2
- Conductor Screen: Extruded Semi-conductive compound
- Insulation: XLPE as per BS 7870-1
- EPR can be provided on demand as per BS 7870-1
- Non-Metallic Insulation Screen: Extruded Semi-conductive compound (Bonded or Cold strippable)
- Separation tape: Semicon water swellable tape
- Metallic Insulation Screen: Copper wire & Copper tape screen
- Separation tape: Plain water swellable tape
- Outer Sheath: Extruded medium density polyethylene or Low smoke zero halogen compound as per BS 7870-1, Colour: Black

Standard and References:

BS EN/IEC 60228
BS 7870-1
BS 7870-4-10

Test Voltage

51kV AC

Impulse Test Voltage

Peak 144kV AC

Compliance

Conductor resistance BS EN/IEC 60228
Insulation resistance BS 7870-4-10
Flame Retardant test BS EN/IEC 60332-1-2
Partial Discharge test BS 7870-4-10
Smoke Emission test BS EN/IEC 61034-2



Bending Radius:

Fixed Installation: 20 x Overall diameter



POLYCAB MV CU BS 7870-4-10 12.7/22 KV Triplex
Medium Voltage Copper wire screened Cable, 12.7/22 (24) KV AC

Product code	No. of Cores	Nominal Cross sectional Area	Nominal area of metallic screen	Overall diameter (Approx.)	Weight (Approx.)
		mm ²	mm ²	mm	Kg/Km
MVBS19CXAWPM001C070S	3 x 1 (triplex)	70	35	63.3	4050
MVBS19CXAWPM001C095S	3 x 1 (triplex)	95	35	66.8	5100
MVBS19CXAWPM001C120S	3 x 1 (triplex)	120	35	70.2	6000
MVBS19CXAWPM001C150S	3 x 1 (triplex)	150	35	73.7	6900
MVBS19CXAWPM001C185S	3 x 1 (triplex)	185	35	77.4	8100
MVBS19CXAWPM001C240S	3 x 1 (triplex)	240	35	82.6	9900
MVBS19CXAWPM001C300S	3 x 1 (triplex)	300	35	87.5	11850
MVBS19CXAWPM001C400S	3 x 1 (triplex)	400	35	94.2	14700
MVBS19CXAWPM001C500S	3 x 1 (triplex)	500	35	101.1	18000
MVBS19CXAWPM001C630S	3 x 1 (triplex)	630	35	108.5	21750
MVBS19CXAWPM001C800S	3 x 1 (triplex)	800	35	124.2	27000
MVBS19CXAWPM001C01KS	3 x 1 (triplex)	1000	35	134	32850

Electrical Characteristics:

Nominal Cross Sectional Area	Max. DC Resistance at 20°C	Max. AC Resistance at 90°C	Short circuit current rating of conductor	Short circuit current rating of metallic screen	Capacitance (Approx.)	Inductance (Approx.)	Reactance (Approx.)
mm ²	Ω/km	Ω/km	kA/s	kA/s	μF/km	mH/km	Ω/km
70	0.268	0.342	10.02	4.5	0.19	0.41	0.13
95	0.193	0.247	13.59	4.5	0.21	0.39	0.12
120	0.153	0.196	17.17	4.5	0.23	0.38	0.12
150	0.124	0.159	21.46	4.5	0.25	0.36	0.11
185	0.0991	0.128	26.47	4.5	0.27	0.35	0.11
240	0.0754	0.098	34.34	4.5	0.30	0.34	0.11
300	0.0601	0.079	42.93	4.5	0.33	0.33	0.10
400	0.047	0.063	57.23	4.5	0.37	0.31	0.10
500	0.0366	0.051	71.54	4.5	0.41	0.25	0.08
630	0.0283	0.042	90.14	4.5	0.45	0.24	0.08
800	0.0221	0.036	114.47	4.5	0.53	0.23	0.07
1000	0.0176	0.032	143.08	4.5	0.59	0.22	0.07



POLYCAB MV CU BS 7870-4-10 12.7/22 KV Triplex
Medium Voltage Copper wire screened Cable, 12.7/22 (24) KV AC

Current Carrying Capacity

No. of core	Nominal cross sectional area mm ²	Ground at 20°C					
		In single-way ducts				In air	
		Trefoil Amp.	Flat spaced Amp.	Trefoil ducts Amp.	Flat Touchng Amp.	Trefoil Amp.	Flat Touchng Amp.
1	70	239	246	227	229	296	303
1	95	285	293	271	274	361	369
1	120	323	332	308	311	417	426
1	150	361	366	343	347	473	481
1	185	406	410	387	391	543	550
1	240	469	470	447	453	641	647
1	300	526	524	504	510	735	739
1	400	590	572	564	571	845	837
1	500	615	561	535	462	911	837
1	630	672	598	582	491	1023	919
1	800	703	605	605	493	1103	960
1	1000	739	626	633	506	1191	1020

Maximum conductor temperature	90°C
Ambient air temperature	30°C
Ground temperature	20°C
Depth of laying	0.8 m
Thermal resistivity of soil	1.5 K.m/W
Thermal resistivity of earthenware ducts	1.2 K.m/W

Current rating de-rating factors for other than 30°C ambient air temperature.

Air Temperature	20	25	35	40	45	50	55	60
De-rating factor	1.08	1.04	0.96	0.91	0.87	0.82	0.76	0.71

Current rating de-rating factors for other than 20°C ground temperature.

Ground Temperature	10	15	25	30	35	40	45	50
De-rating factor	1.07	1.04	0.96	0.93	0.89	0.85	0.8	0.76

POLYCAB MV CU BS 7870-4-10 12.7/22 KV
Medium Voltage Copper wire screened Cable, 12.7/22 (24) KV AC

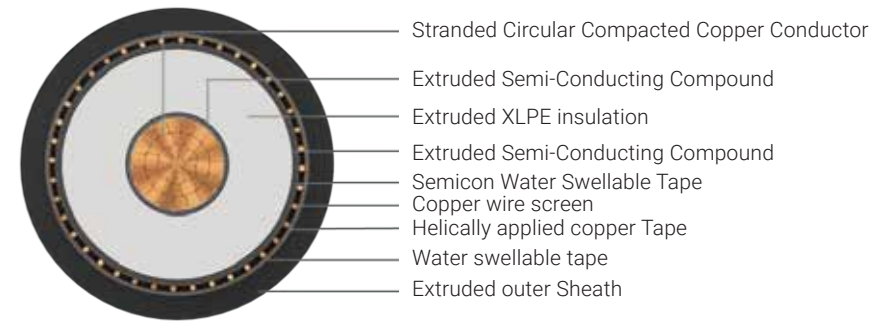

- Outstanding Features**
- Flame retardant
 - High life
 - UV resistant
 - Oil resistant

Application

POLYCAB MV CU BS 7870-4-10 12.7/22 KV compacted copper conductor XLPE insulated, copper wire screened single core cable is designed to use for power networks, underground direct buried or in cable ducting.

Voltage Rating

Nominal Voltage: 12.7/22 (24) kV

Operation Temperature

- Conductor: Circular Compacted Copper conductor as per BS EN/IEC 60228, class 2
- Conductor Screen: Extruded Semi-conductive compound
- Insulation: XLPE as per BS 7870-1
- EPR can be provided on demand as per BS 7870-1
- Non-Metallic Insulation Screen: Extruded Semi-conductive compound (Bonded or Cold strippable)
- Separation tape: Semicon water swellable tape
- Metallic Insulation Screen: Copper wire & Copper tape screen
- Separation tape: Plain water swellable tape
- Outer Sheath: Extruded medium density polyethylene or Low smoke zero halogen compound as per BS 7870-1, Colour: Black

Standard and References:

- BS EN/IEC 60228
- BS 7870-1
- BS 7870-4-10

Test Voltage

51kV AC

Impulse Test Voltage

Peak 144kV AC

Compliance

- CConductor resistance BS EN/IEC 60228
- Insulation resistance BS 7870-4-10
- Flame Retardant test BS EN/IEC 60332-1-2
- Partial Discharge test BS 7870-4-10
- Smoke Emission test BS EN/IEC 61034-2

Bending Radius:

Fixed Installation: 20 x Overall diameter



OUR CERTIFICATION
 ISO 9001 | ISO 14001 | ISO 45001



OUR CERTIFICATION
 ISO 9001 | ISO 14001 | ISO 45001



POLYCAB MV CU BS 7870-4-10 12.7/22 KV
Medium Voltage Copper wire screened Cable, 12.7/22 (24) KV AC

Product code	No. of Cores	Nominal Cross sectional Area	Nominal area of metallic screen	Overall diameter (Approx.)	Weight (Approx.)
		mm ²	mm ²	mm	Kg/Km
MVBS19CXAWPM001C070S	1	70	35	29.3	1350
MVBS19CXAWPM001C095S	1	95	35	30.9	1700
MVBS19CXAWPM001C120S	1	120	35	32.5	2000
MVBS19CXAWPM001C150S	1	150	35	34.1	2300
MVBS19CXAWPM001C185S	1	185	35	35.8	2700
MVBS19CXAWPM001C240S	1	240	35	38.2	3300
MVBS19CXAWPM001C300S	1	300	35	40.5	3950
MVBS19CXAWPM001C400S	1	400	35	43.6	4900
MVBS19CXAWPM001C500S	1	500	35	46.8	6000
MVBS19CXAWPM001C630S	1	630	35	50.2	7250
MVBS19CXAWPM001C800S	1	800	35	57.5	9000
MVBS19CXAWPM001C01KS	1	1000	35	62.0	10950

Electrical Characteristics:

Nominal Cross Sectional Area mm ²	Max. DC Resistance at 20°C Ω/km	Max. AC Resistance at 90°C Ω/km	Short circuit current rating of conductor kA/s	Short circuit current rating of metallic screen kA/s	Capacitance (Approx.) μF/km	Inductance (Approx.) mH/km	Reactance (Approx.) Ω/km
70	0.268	0.342	10.02	4.5	0.19	0.41	0.13
95	0.193	0.247	13.59	4.5	0.21	0.39	0.12
120	0.153	0.196	17.17	4.5	0.23	0.38	0.12
150	0.124	0.159	21.46	4.5	0.25	0.36	0.11
185	0.0991	0.128	26.47	4.5	0.27	0.35	0.11
240	0.0754	0.098	34.34	4.5	0.30	0.34	0.11
300	0.0601	0.079	42.93	4.5	0.33	0.33	0.10
400	0.047	0.063	57.23	4.5	0.37	0.31	0.10
500	0.0366	0.051	71.54	4.5	0.41	0.25	0.08
630	0.0283	0.042	90.14	4.5	0.45	0.24	0.08
800	0.0221	0.036	114.47	4.5	0.53	0.23	0.07
1000	0.0176	0.032	143.08	4.5	0.59	0.22	0.07



OUR CERTIFICATION
ISO 9001 | **ISO 14001** | **ISO 45001**



POLYCAB MV CU BS 7870-4-10 12.7/22 KV
Medium Voltage Copper wire screened Cable, 12.7/22 (24) KV AC

Current Carrying Capacity

No. of core	Nominal cross sectional area mm ²	Ground at 20°C		In single-way ducts		In air	
		Trefoil	Flat spaced	Trefoil ducts	Flat Touchng	Trefoil	Flat Touchng
		Amp.	Amp.	Amp.	Amp.	Amp.	Amp.
1	70	239	246	227	229	296	303
1	95	285	293	271	274	361	369
1	120	323	332	308	311	417	426
1	150	361	366	343	347	473	481
1	185	406	410	387	391	543	550
1	240	469	470	447	453	641	647
1	300	526	524	504	510	735	739
1	400	590	572	564	571	845	837
1	500	615	561	535	462	911	837
1	630	672	598	582	491	1023	919
1	800	703	605	605	493	1103	960
1	1000	739	626	633	506	1191	1020

Maximum conductor temperature 90°C
 Ambient air temperature 30°C
 Ground temperature 20°C
 Depth of laying 0.8 m
 Thermal resistivity of soil 1.5 K.m/W
 Thermal resistivity of earthenware ducts 1.2 K.m/W

Current rating de-rating factors for other than 30°C ambient air temperature.

Air Temperature	20	25	35	40	45	50	55	60
De-rating factor	1.08	1.04	0.96	0.91	0.87	0.82	0.76	0.71

Current rating de-rating factors for other than 20°C ground temperature.

Ground Temperature	10	15	25	30	35	40	45	50
De-rating factor	1.07	1.04	0.96	0.93	0.89	0.85	0.8	0.76



OUR CERTIFICATION
ISO 9001 | **ISO 14001** | **ISO 45001**



POLYCAB MV CU BS 7870-4-10 19/33 KV Triplex
Medium Voltage Copper wire screened Cable, 19/33 (36) KV AC

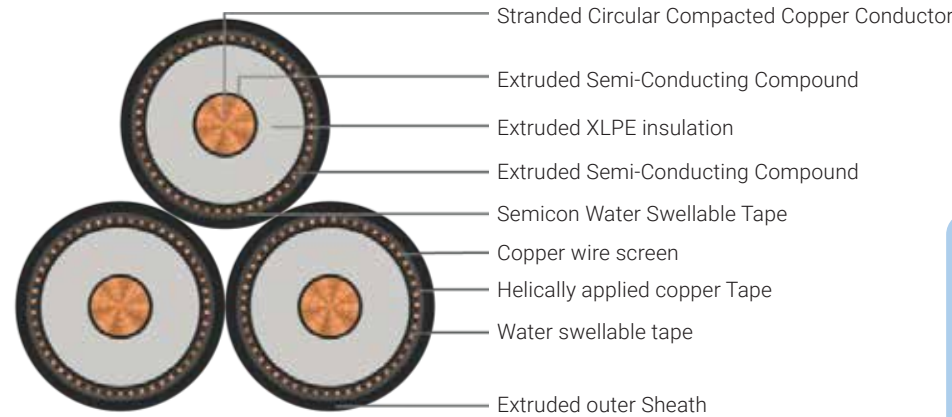

Outstanding Features

- Flame retardant
- High life
- UV resistant
- Oil resistant

Application

POLYCAB MV CU BS 7870-4-10 19/33 KV compacted copper conductor XLPE insulated, copper wire screened cable generally conforming to BS 7870-4-10. These cables are designed for power networks, underground direct buried or in cable ducting.

Voltage Rating

Nominal Voltage: 19/33 (36) kV

Operation Temperature

Max. operating temperature: +90°C
Max. Short Circuit Temperature: 250°C

Construction

- Conductor: Circular Compacted aluminium conductor as per BS EN/IEC 60228, class 2
- Conductor Screen: Extruded Semi-conductive compound
- Insulation: XLPE as per BS 7870-1
- EPR can be provided on demand as per BS 7870-1
- Non-Metallic Insulation Screen: Extruded Semi-conductive compound (Bonded or Cold strippable)
- Separation tape: Semicon water swellable tape
- Metallic Insulation Screen: Copper wire & Copper tape screen
- Separation tape: Plain water swellable tape
- Outer Sheath: Extruded medium density polyethylene or Low smoke zero halogen compound as per BS 7870-1, Colour: Black

Bending Radius:

Fixed Installation: 20 x Overall diameter

Standard and References:

BS EN/IEC 60228
BS 7870-1
BS 7870-4-10

Test Voltage

76kV AC

Impulse Test Voltage

Peak 194kV AC

Compliance

Conductor resistance BS EN/IEC 60228
Insulation resistance BS 7870-4-10
Flame Retardant test BS EN/IEC 60332-1-2
Partial Discharge test BS 7870-4-10
Smoke Emission test BS EN/IEC 61034-2



POLYCAB MV CU BS 7870-4-10 19/33 KV Triplex
Medium Voltage Copper wire screened Cable, 19/33 (36) KV AC

Product code	No. of Cores	Nominal Cross sectional Area	Nominal area of metallic screen	Overall diameter (Approx.)	Weight (Approx.)
		mm ²	mm ²	mm	Kg/Km
MVBS20CXAWPM001C070S	3 x 1 (triplex)	70	35	34.5	1700
MVBS20CXAWPM001C095S	3 x 1 (triplex)	95	35	36.3	2000
MVBS20CXAWPM001C120S	3 x 1 (triplex)	120	35	37.7	2300
MVBS20CXAWPM001C150S	3 x 1 (triplex)	150	35	39.5	2650
MVBS20CXAWPM001C185S	3 x 1 (triplex)	185	35	41.0	3000
MVBS20CXAWPM001C240S	3 x 1 (triplex)	240	35	43.4	3600
MVBS20CXAWPM001C300S	3 x 1 (triplex)	300	35	45.9	4300
MVBS20CXAWPM001C400S	3 x 1 (triplex)	400	35	49.0	5250
MVBS20CXAWPM001C500S	3 x 1 (triplex)	500	35	52.2	6400
MVBS20CXAWPM001C630S	3 x 1 (triplex)	630	35	55.6	7700
MVBS20CXAWPM001C800S	3 x 1 (triplex)	800	35	62.7	9500
MVBS20CXAWPM001C01KS	3 x 1 (triplex)	1000	35	67.4	11500

Electrical Characteristics:

Nominal Cross Sectional Area	Max. DC Resistance at 20°C	Max. AC Resistance at 90°C	Short circuit current rating of conductor	Short circuit current rating of metallic screen	Capacitance (Approx.)	Inductance (Approx.)	Reactance (Approx.)
mm ²	Ω/km	Ω/km	kA/s	kA/s	μF/km	mH/km	Ω/km
70	0.268	0.342	10.02	4.5	0.15	0.45	0.14
95	0.193	0.247	13.59	4.5	0.16	0.43	0.13
120	0.153	0.196	17.17	4.5	0.18	0.41	0.13
150	0.124	0.159	21.46	4.5	0.19	0.39	0.12
185	0.0991	0.128	26.47	4.5	0.20	0.38	0.12
240	0.0754	0.098	34.34	4.5	0.23	0.36	0.11
300	0.0601	0.079	42.93	4.5	0.25	0.35	0.11
400	0.047	0.063	57.23	4.5	0.27	0.34	0.11
500	0.0366	0.051	71.54	4.5	0.30	0.28	0.09
630	0.0283	0.042	90.14	4.5	0.33	0.27	0.08
800	0.0221	0.036	114.47	4.5	0.39	0.25	0.08
1000	0.0176	0.032	143.08	4.5	0.42	0.24	0.08



POLYCAB MV CU BS 7870-4-10 19/33 KV Triplex
Medium Voltage Copper wire screened Cable, 19/33 (36) KV AC

Current Carrying Capacity

Nominal cross sectional area mm ²	Continues Current Rating					
	Buried direct in the ground		In single-way ducts		In air	
	Trefoil Amp.	Flat spaced Amp.	Trefoil ducts Amp.	Flat touching Amp.	Trefoil Amp.	Flat touching Amp.
70	239	246	227	229	296	303
95	285	293	271	274	361	369
120	323	332	308	311	417	426
150	361	366	343	347	473	481
185	406	410	387	391	543	550
240	469	470	447	453	641	647
300	526	524	504	510	735	739
400	590	572	564	571	845	837
500	615	561	535	462	911	837
630	672	598	582	491	1023	919
800	703	605	605	493	1103	960
1000	739	626	633	506	1191	1020

Maximum conductor temperature	90°C
Ambient air temperature	30°C
Ground temperature	20°C
Depth of laying	0.8 m
Thermal resistivity of soil	1.5 K.m/W
Thermal resistivity of earthenware ducts	1.2 K.m/W

Current rating de-rating factors for other than 30°C ambient air temperature.

Air Temperature	20	25	35	40	45	50	55	60
De-rating factor	1.08	1.04	0.96	0.91	0.87	0.82	0.76	0.71

Current rating de-rating factors for other than 20°C ground temperature.

Ground Temperature	10	15	25	30	35	40	45	50
De-rating factor	1.07	1.04	0.96	0.93	0.89	0.85	0.8	0.76

POLYCAB MV CU BS 7870-4-10 19/33 KV
Medium Voltage Copper wire screened Cable, 19/33 (36) KV AC

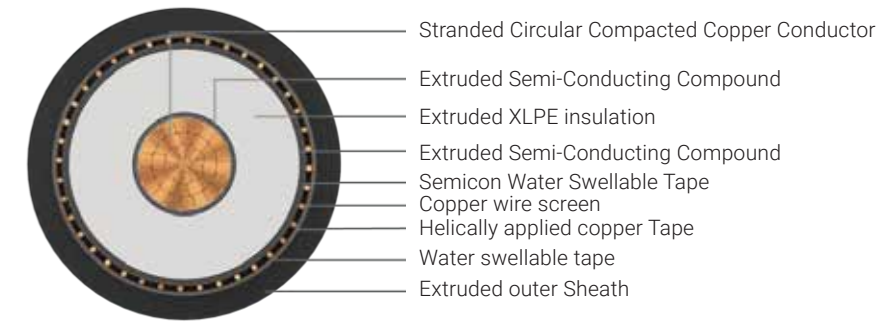

- Outstanding Features**
- Flame retardant
 - High life
 - UV resistant
 - Oil resistant

Application

POLYCAB MV CU BS 7870-4-10 19/33 KV compacted copper conductor XLPE insulated, copper wire screened single core cable is designed to use for power networks, underground direct buried or in cable ducting.

Voltage Rating

Nominal Voltage: 19/33 (36) kV

Operation Temperature

Max. operating temperature: +90°C
 Max. Short Circuit Temperature: 250°C

Construction

- Conductor: Circular Compacted aluminium conductor as per BS EN/IEC 60228, class 2
- Conductor Screen: Extruded Semi-conductive compound
- Insulation: XLPE as per BS 7870-1
- EPR can be provided on demand as per BS 7870-1
- Non-Metallic Insulation Screen: Extruded Semi-conductive compound (Bonded or Cold strippable)
- Separation tape: Semicon water swellable tape
- Metallic Insulation Screen: Copper wire & Copper tape screen
- Separation tape: Plain water swellable tape
- Outer Sheath: Extruded medium density polyethylene or Low smoke zero halogen compound as per BS 7870-1, Colour: Black

Bending Radius:

Fixed Installation: 20 x Overall diameter

Standard and References:

BS EN/IEC 60228
 BS 7870-1
 BS 7870-4-10

Test Voltage

76kV AC

Impulse Test Voltage

Peak 194kV AC

Compliance

Conductor resistance BS EN/IEC 60228
 Insulation resistance BS 7870-4-10
 Flame Retardant test BS EN/IEC 60332-1-2
 Partial Discharge test BS 7870-4-10
 Smoke Emission test BS EN/IEC 61034-2



OUR CERTIFICATION
 ISO 9001 | ISO 14001 | ISO 45001



OUR CERTIFICATION
 ISO 9001 | ISO 14001 | ISO 45001



POLYCAB MV CU BS 7870-4-10 19/33 KV
Medium Voltage Copper wire screened Cable, 19/33 (36) KV AC

Product code	No. of Cores	Nominal Cross sectional Area	Nominal area of metallic screen	Overall diameter (Approx.)	Weight (Approx.)
		mm ²	mm ²	mm	Kg/Km
MVBS20CXAWPM001C070S	1	70	35	34.5	1700
MVBS20CXAWPM001C095S	1	95	35	36.3	2000
MVBS20CXAWPM001C120S	1	120	35	37.7	2300
MVBS20CXAWPM001C150S	1	150	35	39.5	2650
MVBS20CXAWPM001C185S	1	185	35	41.0	3000
MVBS20CXAWPM001C240S	1	240	35	43.4	3600
MVBS20CXAWPM001C300S	1	300	35	45.9	4300
MVBS20CXAWPM001C400S	1	400	35	49.0	5250
MVBS20CXAWPM001C500S	1	500	35	52.2	6400
MVBS20CXAWPM001C630S	1	630	35	55.6	7700
MVBS20CXAWPM001C800S	1	800	35	62.7	9500
MVBS20CXAWPM001C01KS	1	1000	35	67.4	11500

Electrical Characteristics:

Nominal Cross Sectional Area mm ²	Max. DC Resistance at 20°C Ω/km	Max. AC Resistance at 90°C Ω/km	Short circuit current rating of conductor kA/s	Short circuit current rating of metallic screen kA/s	Capacitance (Approx.) μF/km	Inductance (Approx.) mH/km	Reactance (Approx.) Ω/km
70	0.268	0.342	10.02	4.5	0.15	0.45	0.14
95	0.193	0.247	13.59	4.5	0.16	0.43	0.13
120	0.153	0.196	17.17	4.5	0.18	0.41	0.13
150	0.124	0.159	21.46	4.5	0.19	0.39	0.12
185	0.0991	0.128	26.47	4.5	0.20	0.38	0.12
240	0.0754	0.098	34.34	4.5	0.23	0.36	0.11
300	0.0601	0.079	42.93	4.5	0.25	0.35	0.11
400	0.047	0.063	57.23	4.5	0.27	0.34	0.11
500	0.0366	0.051	71.54	4.5	0.30	0.28	0.09
630	0.0283	0.042	90.14	4.5	0.33	0.27	0.08
800	0.0221	0.036	114.47	4.5	0.39	0.25	0.08
1000	0.0176	0.032	143.08	4.5	0.42	0.24	0.08

POLYCAB MV CU BS 7870-4-10 19/33 KV
Medium Voltage Copper wire screened Cable, 19/33 (36) KV AC

Current Carrying Capacity

Nominal cross sectional area mm ²	Continues Current Rating					
	Buried direct in the ground		In single-way ducts		In air	
	Trefoil Amp.	Flat spaced Amp.	Trefoil ducts Amp.	Flat touching Amp.	Trefoil Amp.	Flat touching Amp.
70	239	246	227	229	296	303
95	285	293	271	274	361	369
120	323	332	308	311	417	426
150	361	366	343	347	473	481
185	406	410	387	391	543	550
240	469	470	447	453	641	647
300	526	524	504	510	735	739
400	590	572	564	571	845	837
500	615	561	535	462	911	837
630	672	598	582	491	1023	919
800	703	605	605	493	1103	960
1000	739	626	633	506	1191	1020

Maximum conductor temperature 90°C
 Ambient air temperature 30°C
 Ground temperature 20°C
 Depth of laying 0.8 m
 Thermal resistivity of soil 1.5 K.m/W
 Thermal resistivity of earthenware ducts 1.2 K.m/W

Current rating de-rating factors for other than 30°C ambient air temperature.

Air Temperature	20	25	35	40	45	50	55	60
De-rating factor	1.08	1.04	0.96	0.91	0.87	0.82	0.76	0.71

Current rating de-rating factors for other than 20°C ground temperature.

Ground Temperature	10	15	25	30	35	40	45	50
De-rating factor	1.07	1.04	0.96	0.93	0.89	0.85	0.8	0.76



OUR CERTIFICATION
 ISO 9001 | ISO 14001 | ISO 45001



OUR CERTIFICATION
 ISO 9001 | ISO 14001 | ISO 45001



Polycab, Medium Voltage Copper Wire Screened Power cable conforming to BS 7870-4-20.



These includes medium voltage copper wire screened cable confirming the construction and performance of voltage rating 6.35/11 (12) KV as per BS 7870-4-20. These cables are designed use in power networks, underground direct buried or in cable ducting.

These cables are available in three core with maximum operating conductor temperature of 90°C and maximum short circuit conductor temperature 250°C.

Conductor: High conductivity stranded compacted copper or aluminium conductor produced in-house from state-of-the art machine.

Screen: Semi-conducting compound

Insulation: High insulation resistance cross-linked polyethylene or EPR insulation.

Screen: Insulation screened by semi-conducting compound.

Inner Covering: Semiconducting water swellable tape inner covering over insulated cores.

Screen: Copper wire screen followed by copper tape applied over inner covering as collective metallic screen.

Sheath: In-house developed Medium density polyethylene or Low smoke zero halogen compounding sheath to withstand mechanical abrasion and weather while in use.

Polycab assures the highest quality standard in every product by having stringent quality control with requisite testing which are applied at every single stage from raw material to finished goods.

The construction based on the application and requirement of the user against BS 7870-4-20.



POLYCARB MV AL BS 7870-4-20 6.35/11 KV - Medium Voltage Copper wire screened Cable, 6.35/11 (12) KV AC



POLYCARB MV CU BS 7870-4-20 6.35/11 KV - Medium Voltage Copper wire screened Cable, 6.35/11 (12) KV AC

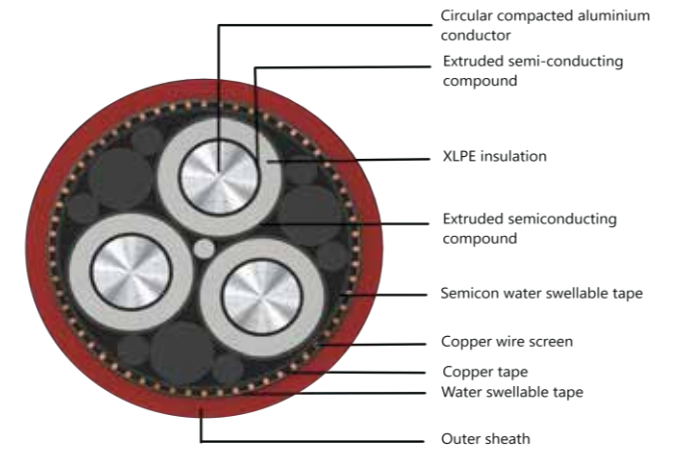

POLYCAB MV AL BS 7870-4-20 6.35/11 KV
Medium Voltage Copper wire screened Cable, 6.35/11 (12) KV AC

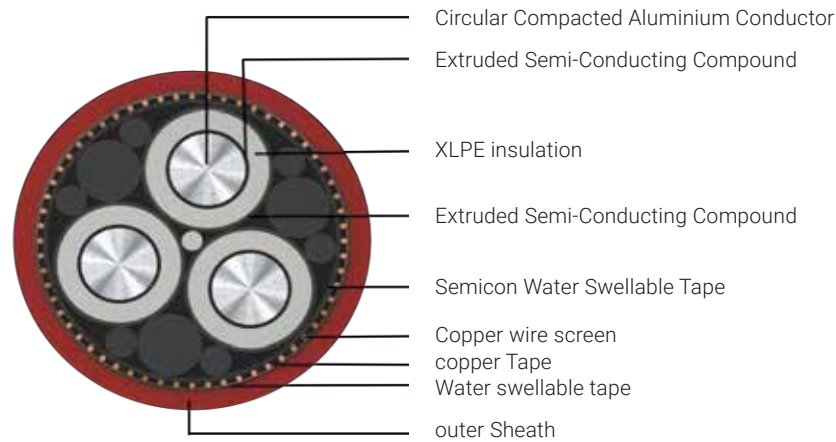

Outstanding Features

- Flame retardant
- High life
- UV resistant
- Oil resistant

Application

POLYCAB MV AL BS 7870-4-20 6.35/11 KV compacted aluminium conductor, XLPE insulated, copper wire screened three core cable is designed for power networks, underground direct buried or in cable ducting.

Voltage Rating

Nominal Voltage: 6.35/11 (12) kV

Operation Temperature

Max. operating temperature: +90°C
Max. Short Circuit Temperature: 250°

Construction

- Conductor: Circular Compacted aluminium conductor as per BS EN/IEC 60228, class 2
- Conductor Screen: Extruded Semi-conductive compound
- Insulation: XLPE as per BS 7870-1
- EPR can be provided on demand as per BS 7870-1
- Non-Metallic Insulation Screen: Extruded Semi-conductive compound (Bonded or Cold strippable)
- Inner covering: Semicon water swellable tape
- Collective Metallic Screen: Copper wire & Copper tape screen
- Separation tape: Plain water swellable tape
- Outer Sheath: Extruded medium density polyethylene or Low smoke zero halogen compound as per BS 7870-1, Colour: Red

Standard and References:

BS EN/IEC 60228
BS 7870-1
BS 7870-4-20

Test Voltage

25.5kV AC

Impulse Test Voltage

Peak 95kV AC

Compliance

Conductor resistance BS EN/IEC 60228
Insulation resistance BS 7870-4-20
Flame Retardant test BS EN/IEC 60332-1-2
Partial Discharge test BS 7870-4-20
Smoke Emission test BS EN/IEC 61034-2



Core identification:

Black with white numbering

Bending Radius:

Fixed Installation: 15 x Overall diameter



POLYCAB MV AL BS 7870-4-20 6.35/11 KV
Medium Voltage Copper wire screened Cable, 6.35/11 (12) KV AC

Product code	No. of Cores	Nominal Cross sectional Area	Nominal area of metallic screen	Overall diameter (Approx.)	Weight (Approx.)
		mm ²	mm ²	mm	Kg/Km
MVBS22AXUAPM003C070S	3	70	35	51.8	2750
MVBS22AXUAPM003C095S	3	95	35	55.5	3200
MVBS22AXUAPM003C120S	3	120	35	58.8	3550
MVBS22AXUAPM003C150S	3	150	35	62.4	4000
MVBS22AXUAPM003C185S	3	185	35	65.9	4500
MVBS22AXUAPM003C240S	3	240	35	71.1	5300
MVBS22AXUAPM003C300S	3	300	35	76.2	6100

Electrical Characteristics:

Nominal Cross Sectional Area mm ²	Max. DC Resistance at 20°C Ω/km	Max. AC Resistance at 90°C Ω/km	Short circuit current rating of conductor kA/s	Short circuit current rating of metallic screen kA/s	Capacitance (Approx.) μF/km	Inductance (Approx.) mH/km	Reactance (Approx.) Ω/km
70	0.443	0.565	6.61	4.5	0.29	0.33	0.10
95	0.32	0.408	8.98	4.5	0.32	0.32	0.10
120	0.253	0.323	11.34	4.5	0.35	0.30	0.09
150	0.206	0.263	14.17	4.5	0.38	0.29	0.09
185	0.164	0.210	17.48	4.5	0.41	0.29	0.09
240	0.125	0.160	22.68	4.5	0.46	0.27	0.09
300	0.1	0.129	28.35	4.5	0.51	0.27	0.08



POLYCAB MV AL BS 7870-4-20 6.35/11 KV
Medium Voltage Copper wire screened Cable, 6.35/11 (12) KV AC

Current Carrying Capacity

No. of core	Nominal cross sectional area mm ²	Continues current capacity		
		In ground at 20°C Amp.	In a buried duct Amp.	In air Amp.
3	70	171	150	196
3	95	204	180	238
3	120	232	206	274
3	150	259	231	309
3	185	293	262	354
3	240	338	304	415
3	300	380	343	472
3	400	432	393	545
3	500	503	443	649

Maximum conductor temperature	90°C
Ambient air temperature	30°C
Ground temperature	20°C
Depth of laying	0.8 m
Thermal resistivity of soil	1.5 K.m/W
Thermal resistivity of earthenware ducts	1.2 K.m/W

Current rating de-rating factors for other than 30°C ambient air temperature.

Air Temperature	20	25	35	40	45	50	55	60
De-rating factor	1.08	1.04	0.96	0.91	0.87	0.82	0.76	0.71

Current rating de-rating factors for other than 20°C ground temperature.

Ground Temperature	10	15	25	30	35	40	45	50
De-rating factor	1.07	1.04	0.96	0.93	0.89	0.85	0.8	0.76

POLYCAB MV CU BS 7870-4-20 6.35/11 KV
Medium Voltage Copper wire screened Cable, 6.35/11 (12) KV AC

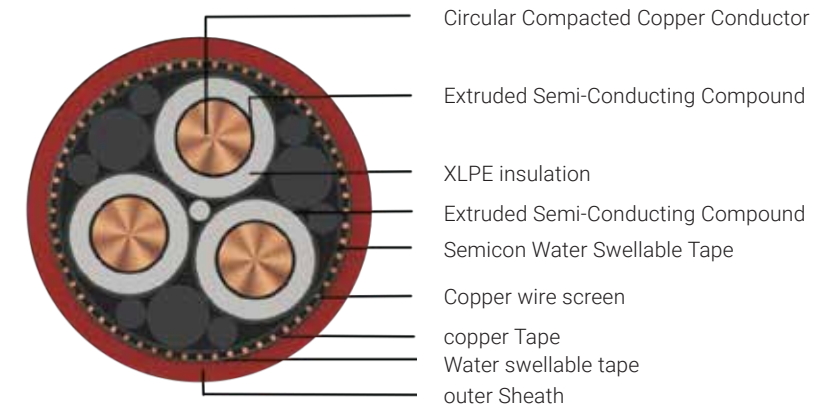

Outstanding Features

- Flame retardant
- High life
- UV resistant
- Oil resistant

Application

POLYCAB MV CU BS 7870-4-20 6.35/11 KV compacted copper conductor, XLPE insulated, copper wire screened three core cable is designed for power networks, underground direct buried or in cable ducting.

Voltage Rating

Nominal Voltage: 6.35/11 (12) kV

Operation Temperature

Max. operating temperature: +90°C
 Max. Short Circuit Temperature: 250°C

Construction

- Conductor: Circular Compacted Copper conductor as per BS EN/IEC 60228, class 2
- Conductor Screen: Extruded Semi-conductive compound
- Insulation: XLPE as per BS 7870-1
- EPR can be provided on demand as per BS 7870-1
- Non-Metallic Insulation Screen: Extruded Semi-conductive compound (Bonded or Cold strippable)
- Inner covering: Semicon water swellable tape
- Collective Metallic Screen: Copper wire & Copper tape screen
- Separation tape: Plain water swellable tape
- Outer Sheath: Extruded medium density polyethylene or Low smoke zero halogen compound as per BS 7870-1, Colour: Red

Core identification:

Black with white numbering

Bending Radius:

Fixed Installation: 15 x Overall diameter

Standard and References:

BS EN/IEC 60228
 BS 7870-1
 BS 7870-4-20

Test Voltage

25.5kV AC

Impulse Test Voltage

Peak 95kV AC

Compliance

Conductor resistance BS EN/IEC 60228
 Insulation resistance BS 7870-4-20
 Flame Retardant test BS EN/IEC 60332-1-2
 Partial Discharge test BS 7870-4-20
 Smoke Emission test BS EN/IEC 61034-2



OUR CERTIFICATION
 ISO 9001 | ISO 14001 | ISO 45001



OUR CERTIFICATION
 ISO 9001 | ISO 14001 | ISO 45001



POLYCAB MV CU BS 7870-4-20 6.35/11 KV
Medium Voltage Copper wire screened Cable, 6.35/11 (12) KV AC

Product code	No. of Cores	Nominal Cross sectional Area	Nominal area of metallic screen	Overall diameter (Approx.)	Weight (Approx.)
		mm ²	mm ²	mm	Kg/Km
MVBS22CXUAPM003C070S	3	70	35	51.8	3950
MVBS22CXUAPM003C095S	3	95	35	55.5	4800
MVBS22CXUAPM003C120S	3	120	35	58.8	5650
MVBS22CXUAPM003C150S	3	150	35	62.4	6700
MVBS22CXUAPM003C185S	3	185	35	65.8	7800
MVBS22CXUAPM003C240S	3	240	35	71.1	9650
MVBS22CXUAPM003C300S	3	300	35	76.2	11700

Electrical Characteristics:

Nominal Cross Sectional Area mm ²	Max. DC Resistance at 20°C Ω/km	Max. AC Resistance at 90°C Ω/km	Short circuit current rating of conductor kA/s	Short circuit current rating of metallic screen kA/s	Capacitance (Approx.) μF/km	Inductance (Approx.) mH/km	Reactance (Approx.) Ω/km
70	0.268	0.342	10.02	4.5	0.29	0.33	0.10
95	0.193	0.247	13.59	4.5	0.32	0.32	0.10
120	0.153	0.196	17.17	4.5	0.35	0.30	0.09
150	0.124	0.159	21.46	4.5	0.38	0.29	0.09
185	0.0991	0.127	26.47	4.5	0.41	0.29	0.09
240	0.0754	0.098	34.34	4.5	0.46	0.27	0.09
300	0.0601	0.078	42.93	4.5	0.51	0.27	0.08

POLYCAB MV CU BS 7870-4-20 6.35/11 KV
Medium Voltage Copper wire screened Cable, 6.35/11 (12) KV AC

Current Carrying Capacity

No. of core	Nominal cross sectional area mm ²	Continues current capacity		
		In ground at 20°C Amp.	In a buried duct Amp.	In air Amp.
3	70	221	193	253
3	95	262	231	304
3	120	298	264	351
3	150	334	297	398
3	185	377	336	455
3	240	434	390	531
3	300	489	441	606

Maximum conductor temperature 90°C
 Ambient air temperature 30°C
 Ground temperature 20°C
 Depth of laying 0.8 m
 Thermal resistivity of soil 1.5 K.m/W
 Thermal resistivity of earthenware ducts 1.2 K.m/W
 Note: The above table in accordance with IEC 60502-2

Current rating de-rating factors for other than 30°C ambient air temperature.

Air Temperature	20	25	35	40	45	50	55	60
De-rating factor	1.08	1.04	0.96	0.91	0.87	0.82	0.76	0.71

Current rating de-rating factors for other than 20°C ground temperature.

Ground Temperature	10	15	25	30	35	40	45	50
De-rating factor	1.07	1.04	0.96	0.93	0.89	0.85	0.8	0.76



OUR CERTIFICATION
ISO 9001 | ISO 14001 | ISO 45001



OUR CERTIFICATION
ISO 9001 | ISO 14001 | ISO 45001



Polycab Medium Voltage High Tension Cable conforming to IEC 60502 - 2



Polycab Medium Voltage High Tension cables, with voltage grades ranging from 3.6 kV to 36 kV, are widely used in direct burial applications as part of the power distribution network. These cables are available with XLPE insulation that has a temperature rating of 90°C.

The cables are halogen free, flame retardant and provide extra protection from short circuit and fire.

Conductor: The high conductivity annealed plain stranded compacted aluminium/copper conductor is produced in-house with highly advanced machines.

Conductor Screen: It's an extruded layer of semi-conducting compound that eliminates the risk of electric discharge at the interface between conductor and insulation. It also prevents electrical stress concentrations on the surface of the conductor.

Insulation: The cross-linked polyethylene thermoset insulation compound, developed in-house, provides high degree of insulation resistance.

Non-metallic Insulation Screen: An extruded layer of cross-linked semi-conducting compound, it forms the third protective layer after conductor screen and insulation. The screen eliminates micro voids and curing, thus extending the life of the cable.

Metallic Screen: A helically applied copper tape screen to carry fault current.

Laying Up: In case of 3 Core Cable, insulated cores are laid up together with fillers, developed in-house, to maintain circularity of cable.

Inner Sheath: A thermoplastic, halogen free PVC compound, developed in-house, it emits less smoke and corrosive gases when exposed to fire. The sheath also maintains the circular shape of cable.

Armour: An Aluminium/Galvanised steel round wire that provides mechanical protection and also acts as return path for the earth fault current.

Outer Sheath: Developed in-house, this thermoplastic compound emits less smoke and corrosive gases when exposed to fire.

The construction is based on the application and requirement of the user against IEC 60502-2 / BS 6622.



**POLYCAB MV CU IEC 60502-2 3.6/6.0 KV -
Medium Voltage Armoured Cable, 3.6/6.0 (7.2) KV AC**



**POLYCAB MV CU IEC 60502-2 6.0/10 KV -
Medium Voltage Armoured Cable, 6.0/10 (12) KV AC**



**POLYCAB MV CU IEC 60502-2 8.7/15 KV -
Medium Voltage Armoured Cable, 8.7/15 (17.5) KV AC**



**POLYCAB MV CU IEC 60502-2 12/20 KV -
Medium Voltage Armoured Cable, 12/20 (24) KV AC**



**POLYCAB MV CU IEC 60502-2 18/30 KV -
Medium Voltage Armoured Cable, 18/30 (36) KV AC**



**POLYCAB MV AL IEC 60502-2 3.6/6.0 KV -
Medium Voltage Armoured Cable, 3.6/6.0 (7.2) KV AC**



**POLYCAB MV AL IEC 60502-2 6.0/10 KV -
Medium Voltage Armoured Cable, 6.0/10 (12) KV AC**



**POLYCAB MV AL IEC 60502-2 8.7/15 KV -
Medium Voltage Armoured Cable, 8.7/15 (17.5) KV AC**



**POLYCAB MV AL IEC 60502-2 12/20 KV -
Medium Voltage Armoured Cable, 12/20 (24) KV AC**



**POLYCAB MV AL IEC 60502-2 18/30 KV -
Medium Voltage Armoured Cable, 18/30 (36) KV AC**

POLYCAB MV CU IEC 60502-2 3.6/6 KV
Medium Voltage Copper Armoured Cable, 3.6/6 (7.2) KV AC

Single Core



Three Core



Outstanding Features

- Flame retardant
- High life
- UV resistant
- Oil resistant

Application

POLYCAB MV 3.6/6 KV XLPE insulated with copper conductor single & multi core cable is suitable to use for power distribution for external and direct burial applications in power network system.

Voltage Rating

Nominal Voltage: 3.6/6 kV

Operation Temperature

Max. operating temperature: +90°C
Max. Short Circuit Temperature: 250°C

Construction

- Conductor: Circular Compacted Copper conductor as per IEC 60228, class 2
- Conductor Screen: Extruded Semi-conductive compound
- Insulation: XLPE
- Non-Metallic Insulation Screen: Extruded Semi-conductive compound
- Metallic Insulation Screen: Copper tape screen
- Inner Sheath: Extruded Polyvinyl Chloride
- Armour:
 - Single Core: Aluminium Round Wire Armoured (AWA)
 - Multi Core: Galvanised Steel Round Wire Armoured (SWA)
- Outer Sheath: Extruded Polyvinyl Chloride, Colour: Black

Standard and References:

IEC 60228
IEC 60502-2
BS 6622

Test Voltage

12.5kV AC 50 Hz

Impulse Test Voltage

Peak 60kV AC

Compliance

- Conductor resistance IEC 60228
- Insulation resistance IEC 60502-2
- Flammability test IEC 60332-1-2
- Partial Discharge test IEC 60502-2



Bending Radius: 12D

Fixed Installation: 12D
D is overall diameter of cable



POLYCAB MV CU IEC 60502-2 3.6/6 KV
Medium Voltage Copper Armoured Cable, 3.6/6 (7.2) KV AC

DIMENSIONAL CHARACTERISTICS:

Product Code	No. of Cores	Core Cross sectional Area	Nominal Diameter			Weight (Approx.)
			Under armour	Over armour	Overall	
	No.	mm ²	mm	mm	mm	Kg/Km
MVIE21CXAWY2001C035SA001P	1	35	16.3	19.5	23.0	950
MVIE21CXAWY2001C050SA001P	1	50	17.8	21.0	25.0	1100
MVIE21CXAWY2001C070SA001P	1	70	19.4	22.6	27.0	1350
MVIE21CXAWY2001C095SA001P	1	95	21.2	24.4	29.0	1600
MVIE21CXAWY2001C120SA001P	1	120	22.8	26	30.0	1900
MVIE21CXAWY2001C150SA001P	1	150	24.5	27.7	32.0	2250
MVIE21CXAWY2001C185SA001P	1	185	26.2	30.2	35.0	2700
MVIE21CXAWY2001C240SA001P	1	240	28.8	32.8	37.0	3350
MVIE21CXAWY2001C300SA001P	1	300	31.7	35.7	40.0	4050
MVIE21CXAWY2001C400SA001P	1	400	35.3	39.3	44.0	5050
MVIE21CXAWY2001C500SA001P	1	500	39.2	44.2	49.0	6400
MVIE21CXAWY2001C630SA001P	1	630	42.9	47.9	53.0	7700
MVIE21CXAWY2001C800SA001P	1	800	46.9	51.9	57.0	9450
MVIE21CXAWY2001C01KSA001P	1	1000	51.2	56.2	62.0	11450
MVIE21CXSWY2003C035SA001P	3	35	32.6	36.6	41.0	3400
MVIE21CXSWY2003C050SA001P	3	50	36.1	41.1	46.0	4500
MVIE21CXSWY2003C070SA001P	3	70	39.7	44.7	50.0	5400
MVIE21CXSWY2003C095SA001P	3	95	43.6	48.6	54.0	6500
MVIE21CXSWY2003C120SA001P	3	120	47.1	52.1	58.0	7600
MVIE21CXSWY2003C150SA001P	3	150	50.9	55.9	62.0	8850
MVIE21CXSWY2003C185SA001P	3	185	54.7	59.7	66.0	10200
MVIE21CXSWY2003C240SA001P	3	240	60.6	65.6	72.0	12500
MVIE21CXSWY2003C300SA001P	3	300	67.1	73.4	80.0	15950
MVIE21CXSWY2003C400SA001P	3	400	75.3	81.6	89.0	19800



POLYCAB MV CU IEC 60502-2 3.6/6 KV
Medium Voltage Copper Armoured Cable, 3.6/6 (7.2) KV AC

ELECTRICAL CHARACTERISTICS:

No. of Cores	Core Cross sectional Area mm ²	Max. DC Resistance at 20°C Ω/km	Max. AC Resistance at 90°C Ω/km	Approx. Capacitance μF/km	Approx. Inductance mH/km	Approx. Reactance Ω/km	Continuous Current Rating					
							In ground at 20°C		In Ducts		In air at 30°C	
							Flat	Trefoil	Flat	Trefoil	Flat	Trefoil
No.	mm ²	Ω/km	Ω/km	μF/km	mH/km	Ω/km	Amps					
1	35	0.524	0.668	0.25	0.42	0.13	172	166	159	157	203	198
1	50	0.387	0.494	0.29	0.39	0.12	203	196	188	186	243	238
1	70	0.268	0.342	0.33	0.37	0.12	246	239	229	227	303	296
1	95	0.193	0.247	0.38	0.36	0.11	293	285	274	271	369	361
1	120	0.153	0.196	0.41	0.34	0.11	332	323	311	308	426	417
1	150	0.124	0.159	0.46	0.33	0.10	366	361	347	343	481	473
1	185	0.0991	0.127	0.50	0.33	0.10	410	406	391	387	550	543
1	240	0.0754	0.097	0.54	0.31	0.10	470	469	453	447	647	641
1	300	0.0601	0.078	0.57	0.31	0.10	524	526	510	504	739	735
1	400	0.0470	0.062	0.61	0.30	0.09	572	590	571	564	837	845
1	500	0.0366	0.052	0.71	0.24	0.08	660	655	640	635	970	960
1	630	0.0283	0.042	0.78	0.24	0.07	735	730	715	710	1110	1100
1	800	0.0221	0.036	0.87	0.23	0.07	770	820	800	790	1260	1250
1	1000	0.0176	0.032	0.96	0.22	0.07	825	885	865	855	1420	1410

No. of Cores	Core Cross sectional Area mm ²	Max. DC Resistance at 20°C Ω/km	Max. AC Resistance at 90°C Ω/km	Approx. Capacitance μF/km	Approx. Inductance mH/km	Approx. Reactance Ω/km	Continuous Current Rating		
							In ground at 20°C		In air at 30°C
							Amps		
3	35	0.524	0.668	0.25	0.42	0.090	154	134	172
3	50	0.387	0.494	0.29	0.32	0.096	181	158	205
3	70	0.268	0.342	0.33	0.30	0.092	220	194	253
3	95	0.193	0.247	0.38	0.29	0.088	263	232	307
3	120	0.153	0.196	0.41	0.28	0.085	298	264	352
3	150	0.124	0.159	0.46	0.27	0.083	332	296	397
3	185	0.0991	0.127	0.50	0.26	0.081	374	335	453
3	240	0.0754	0.097	0.54	0.26	0.079	431	387	529
3	300	0.0601	0.078	0.57	0.25	0.078	482	435	599
3	400	0.0470	0.062	0.61	0.25	0.077	541	492	683

Maximum conductor temperature 90°C
 Ambient air temperature 30°C
 Ground temperature 20°C
 Depth of laying 0.8 m
 Thermal resistivity of soil 1.5 K.m/W
 Thermal resistivity of earthenware ducts 1.2 K.m/W

Current rating de-rating factors for other than 30°C ambient air temperature.

Air Temperature	20	25	35	40	45	50	55	60
De-rating factor	1.08	1.04	0.96	0.91	0.87	0.82	0.76	0.71

Current rating de-rating factors for other than 20°C ground temperature.

Ground Temperature	10	15	25	30	35	40	45	50
De-rating factor	1.07	1.04	0.96	0.93	0.89	0.85	0.8	0.76

POLYCAB MV CU IEC 60502-2 6/10 KV
Medium Voltage Copper Armoured Cable, 6/10 (12) KV AC

Single Core



Three Core



Outstanding Features

- Flame retardant
- High life
- UV resistant
- Oil resistant

Application

POLYCAB MV 6/10 KV XLPE insulated with copper conductor single & multi core cable is suitable to use for power networks, underground and in cable ducting.

Voltage Rating

Nominal Voltage: 6/10 kV

Operation Temperature

Max. operating temperature: +90°C
 Max. Short Circuit Temperature: 250°C

Construction

- Conductor: Circular Compacted Copper conductor as per IEC 60228, class 2
- Conductor Screen: Extruded Semi-conductive compound
- Insulation: XLPE
- Non-Metallic Insulation Screen: Extruded Semi-conductive compound
- Metallic Insulation Screen: Copper tape screen
- Inner Sheath: Extruded Polyvinyl Chloride
- Armour:
 Single Core: Aluminium Round Wire Armoured (AWA)
 Multi Core: Galvanised Steel Round Wire (SWA)
- Outer Sheath: Extruded Polyvinyl Chloride, Colour: Black

Standard and References:

IEC 60228
 IEC 60502-2
 BS 6622

Test Voltage

21kV AC 50 Hz

Impulse Test Voltage

Peak 75kV AC

Compliance

- Conductor resistance IEC 60228
- Insulation resistance IEC 60502-2
- Flammability test IEC 60332-1-2
- Fire Retardant IEC 60332-3-22
- Partial Discharge test IEC 60502-2



Bending Radius:

Fixed Installation: 12D
 D is overall diameter of cable



OUR CERTIFICATION
 ISO 9001 | ISO 14001 | ISO 45001



OUR CERTIFICATION
 ISO 9001 | ISO 14001 | ISO 45001



DIMENSIONAL CHARACTERISTICS:

Product Code	No. of Cores	Core Cross sectional Area	Nominal Diameter			Weight (Approx.)
			Under armour	Over armour	Overall	
	No.	mm ²	mm	mm	mm	Kg/Km
MVIE22CXAWY2001C050SA001P	1	50	19.6	22.8	26.0	1200
MVIE22CXAWY2001C070SA001P	1	70	21.2	24.4	28.0	1450
MVIE22CXAWY2001C095SA001P	1	95	23.0	26.2	30.0	1700
MVIE22CXAWY2001C120SA001P	1	120	24.6	27.8	32.0	2050
MVIE22CXAWY2001C150SA001P	1	150	26.3	30.3	35.0	2450
MVIE22CXAWY2001C185SA001P	1	185	28.0	32.0	36.0	2850
MVIE22CXAWY2001C240SA001P	1	240	30.4	34.4	39.0	3450
MVIE22CXAWY2001C300SA001P	1	300	32.9	36.9	41.0	4150
MVIE22CXAWY2001C400SA001P	1	400	36.1	40.1	45.0	5150
MVIE22CXAWY2001C500SA001P	1	500	41.0	44.6	50.0	6450
MVIE22CXAWY2001C630SA001P	1	630	43.2	48.2	54.0	7800
MVIE22CXAWY2001C800SA001P	1	800	47.3	52.3	58.0	9550
MVIE22CXAWY2001C01KSA001P	1	1000	51.8	56.8	63.0	11650
MVIE22CXSWY2003C035SA001P	3	35	38.1	43.1	50.0	4400
MVIE22CXSWY2003C050SA001P	3	50	40.2	45.2	54.0	5050
MVIE22CXSWY2003C070SA001P	3	70	43.6	48.6	59.0	5900
MVIE22CXSWY2003C095SA001P	3	95	47.7	52.7	62.0	7100
MVIE22CXSWY2003C120SA001P	3	120	51.2	56.2	66.0	8200
MVIE22CXSWY2003C150SA001P	3	150	55.0	60.0	70.0	9550
MVIE22CXSWY2003C185SA002PS	3	185	58.8	63.8	77.0	10900
MVIE22CXSWY2003C240SA001P	3	240	64.3	70.6	83.0	14000
MVIE22CXSWY2003C300SA001P	3	300	69.9	76.2	91.0	16550
MVIE22CXSWY2003C400SA001P	3	400	77.0	83.3	26.0	20100

ELECTRICAL CHARACTERISTICS:

No. of Cores	Core Cross sectional Area	Max. DC Resistance at 20°C	Max. AC Resistance at 90°C	Approx. Capacitance	Approx. Inductance	Approx. Reactance	Continuous Current Rating					
							In ground at 20°C		In Ducts		In air at 30°C	
							Flat	Trefoil	Flat	Trefoil	Flat	Trefoil
No.	mm ²	Ω/km	Ω/km	μF/km	mH/km	Ω/km	Amps					
1	50	0.387	0.494	0.23	0.41	0.13	203	196	188	186	243	238
1	70	0.268	0.342	0.26	0.39	0.12	246	239	229	227	303	296
1	95	0.193	0.247	0.30	0.37	0.12	293	285	274	271	369	361
1	120	0.153	0.196	0.33	0.35	0.11	332	323	311	308	426	417
1	150	0.124	0.159	0.36	0.35	0.11	366	361	347	343	481	473
1	185	0.0991	0.127	0.39	0.34	0.11	410	406	391	387	550	543
1	240	0.0754	0.097	0.44	0.32	0.10	470	469	453	447	647	641
1	300	0.0601	0.078	0.49	0.31	0.10	524	526	510	504	739	735
1	400	0.0470	0.062	0.55	0.30	0.09	572	590	571	564	837	845
1	500	0.0366	0.052	0.67	0.25	0.08	660	655	640	635	970	960
1	630	0.0283	0.042	0.74	0.24	0.08	735	730	715	710	1110	1100
1	800	0.0221	0.036	0.82	0.23	0.07	770	820	800	790	1260	1250
1	1000	0.0176	0.032	0.91	0.22	0.07	825	885	865	855	1420	1410

No. of Cores	Core Cross sectional Area	Max. DC Resistance at 20°C	Max. AC Resistance at 90°C	Approx. Capacitance	Approx. Inductance	Approx. Reactance	Continuous Current Rating				
							In ground at 20°C		In Ducts		In air at 30°C
							Amps				
No.	mm ²	Ω/km	Ω/km	μF/km	mH/km	Ω/km	Amps				
3	35	0.524	0.668	0.32	0.41	0.09	154	134	172		
3	50	0.387	0.494	0.23	0.33	0.10	181	158	205		
3	70	0.268	0.342	0.26	0.31	0.10	220	194	253		
3	95	0.193	0.247	0.30	0.30	0.09	263	232	307		
3	120	0.153	0.196	0.33	0.29	0.09	298	264	352		
3	150	0.124	0.159	0.36	0.28	0.09	332	296	397		
3	185	0.0991	0.127	0.39	0.27	0.09	374	335	453		
3	240	0.0754	0.097	0.44	0.26	0.08	431	387	529		
3	300	0.0601	0.078	0.49	0.26	0.08	482	435	599		
3	400	0.0470	0.062	0.55	0.25	0.08	541	492	683		

Maximum conductor temperature 90°C
 Ambient air temperature 30°C
 Ground temperature 20°C
 Depth of laying 0.8 m
 Thermal resistivity of soil 1.5 K.m/W
 Thermal resistivity of earthenware ducts 1.2 K.m/W

Current rating de-rating factors for other than 30°C ambient air temperature.

Air Temperature	20	25	35	40	45	50	55	60
De-rating factor	1.08	1.04	0.96	0.91	0.87	0.82	0.76	0.71

Current rating de-rating factors for other than 20°C ground temperature.

Ground Temperature	10	15	25	30	35	40	45	50
De-rating factor	1.07	1.04	0.96	0.93	0.89	0.85	0.8	0.76



OUR CERTIFICATION
 ISO 9001 | ISO 14001 | ISO 45001



OUR CERTIFICATION
 ISO 9001 | ISO 14001 | ISO 45001



POLYCAB MV CU IEC 60502-2 8.7/15 KV
Medium Voltage Copper Armoured Cable, 8.7/15 (17.5) KV AC

Single Core



Three Core



Outstanding Features

- Flame retardant
- High life
- UV resistant
- Oil resistant

Application

POLYCAB MV 8.7/15 KV XLPE insulated with copper conductor single & multi core cable is suitable to use for power networks, underground and in cable ducting.

Voltage Rating

Nominal Voltage: 8.7/15 kV

Operation Temperature

Max. operating temperature: +90°C
Max. Short Circuit Temperature: 250°C

Construction

- Conductor: Circular Compacted Copper conductor as per IEC 60228, class 2
- Conductor Screen: Extruded Semi-conductive compound
- Insulation: XLPE
- Non-Metallic Insulation Screen: Extruded Semi-conductive compound
- Metallic Insulation Screen: Copper tape screen
- Inner Sheath: Extruded Polyvinyl Chloride
- Armour:
 - Single Core: Aluminium Round Wire Armoured (AWA)
 - Multi Core: Galvanised Steel Round Wire (SWA)
- Outer Sheath: Extruded Polyvinyl Chloride, Colour: Black

Standard and References:

IEC 60228
IEC 60502-2
BS 6622

Test Voltage

30.5kV AC 50Hz

Impulse Test Voltage

Peak 95kV AC

Compliance

- Conductor resistance IEC 60228
- Insulation resistance IEC 60502-2
- Flammability test IEC 60332-1-2
- Partial Discharge test IEC 60502-2



Bending Radius:

Fixed Installation: 12D
D is overall diameter of cable



POLYCAB MV CU IEC 60502-2 8.7/15 KV
Medium Voltage Copper Armoured Cable, 8.7/15 (17.5) KV AC

DIMENSIONAL CHARACTERISTICS:

Product Code	No. of Cores	Core Cross sectional Area	Nominal Diameter			Weight (Approx.)
			Under armour	Over armour	Overall	
	No.	mm ²	mm	mm	mm	Kg/Km
MVIE23CXAWY2001C050SA001P	1	50	21.8	25.0	29.0	1300
MVIE23CXAWY2001C070SA001P	1	70	23.4	26.6	30.0	1600
MVIE23CXAWY2001C095SA001P	1	95	25.2	29.2	33.0	1950
MVIE23CXAWY2001C120SA001P	1	120	26.8	30.8	35.0	2200
MVIE23CXAWY2001C150SA001P	1	150	28.5	32.5	37.0	2600
MVIE23CXAWY2001C185SA001P	1	185	30.2	34.2	39.0	3000
MVIE23CXAWY2001C240SA001P	1	240	32.6	36.6	41.0	3650
MVIE23CXAWY2001C300SA001P	1	300	35.1	39.1	44.0	4300
MVIE23CXAWY2001C400SA001P	1	400	38.5	43.5	49.0	5350
MVIE23CXAWY2001C500SA001P	1	500	41.8	46.8	52.0	6700
MVIE23CXAWY2001C630SA001P	1	630	45.4	50.4	56.0	8050
MVIE23CXAWY2001C800SA001P	1	800	49.7	54.7	60.0	9850
MVIE23CXAWY2001C01KSA001P	1	1000	54.2	59.2	65.0	11950
MVIE23CXSWY2003C035SA001P	3	35	38.1	43.1	48.0	4900
MVIE23CXSWY2003C050SA001P	3	50	40.2	45.2	50.0	5700
MVIE23CXSWY2003C070SA001P	3	70	43.6	48.6	54.0	6650
MVIE23CXSWY2003C095SA001P	3	95	47.7	52.7	59.0	7850
MVIE23CXSWY2003C120SA001P	3	120	51.2	56.2	62.0	8950
MVIE23CXSWY2003C150SA001P	3	150	55.0	60.0	66.0	10300
MVIE23CXSWY2003C185SA001P	3	185	58.8	63.8	70.0	12550
MVIE23CXSWY2003C240SA001P	3	240	64.3	70.6	77.0	14950
MVIE23CXSWY2003C300SA001P	3	300	69.9	76.2	83.0	17500
MVIE23CXSWY2003C400SA001P	3	400	77.0	83.3	91.0	21100



POLYCAB MV CU IEC 60502-2 8.7/15 KV
Medium Voltage Copper Armoured Cable, 8.7/15 (17.5) KV AC

ELECTRICAL CHARACTERISTICS:

No. of Cores	Core Cross sectional Area mm ²	Max. DC Resistance at 20°C Ω/km	Max. AC Resistance at 90°C Ω/km	Approx. Capacitance μF/km	Approx. Inductance mH/km	Approx. Reactance Ω/km	Continuous Current Rating					
							In ground at 20°C		In Ducts		In air at 30°C	
							Flat	Trefoil	Flat	Trefoil	Flat	Trefoil
No.	mm ²	Ω/km	Ω/km	μF/km	mH/km	Ω/km	Amps					
1	50	0.387	0.494	0.19	0.42	0.13	203	196	188	186	243	238
1	70	0.268	0.342	0.22	0.40	0.13	246	239	229	227	303	296
1	95	0.193	0.247	0.24	0.39	0.12	293	285	274	271	369	361
1	120	0.153	0.196	0.27	0.37	0.12	332	323	311	308	426	417
1	150	0.124	0.159	0.29	0.36	0.11	366	361	347	343	481	473
1	185	0.0991	0.127	0.32	0.35	0.11	410	406	391	387	550	543
1	240	0.0754	0.097	0.35	0.34	0.11	470	469	453	447	647	641
1	300	0.0601	0.078	0.39	0.32	0.10	524	526	510	504	739	735
1	400	0.0470	0.062	0.44	0.32	0.10	572	590	571	564	837	845
1	500	0.0366	0.052	0.52	0.26	0.08	660	655	640	635	970	960
1	630	0.0283	0.042	0.57	0.25	0.08	735	730	715	710	1110	1100
1	800	0.0221	0.036	0.64	0.24	0.07	770	820	800	790	1260	1250
1	1000	0.0176	0.032	0.70	0.23	0.07	825	885	865	855	1420	1410

No. of Cores	Core Cross sectional Area mm ²	Max. DC Resistance at 20°C Ω/km	Max. AC Resistance at 90°C Ω/km	Approx. Capacitance μF/km	Approx. Inductance mH/km	Approx. Reactance Ω/km	Continuous Current Rating		
							In ground at 20°C	In Ducts	In air at 30°C
							Amps		
3	35	0.524	0.668	0.26	0.43	0.10	154	134	172
3	50	0.387	0.494	0.19	0.35	0.11	181	158	205
3	70	0.268	0.342	0.22	0.34	0.11	220	194	253
3	95	0.193	0.247	0.24	0.32	0.10	263	232	307
3	120	0.153	0.196	0.27	0.31	0.10	298	264	352
3	150	0.124	0.159	0.29	0.30	0.09	332	296	397
3	185	0.0991	0.127	0.32	0.29	0.09	374	335	453
3	240	0.0754	0.097	0.35	0.28	0.09	431	387	529
3	300	0.0601	0.078	0.39	0.27	0.09	482	435	599
3	400	0.0470	0.062	0.44	0.26	0.08	541	492	683

Maximum conductor temperature	90°C
Ambient air temperature	30°C
Ground temperature	20°C
Depth of laying	0.8 m
Thermal resistivity of soil	1.5 K.m/W
Thermal resistivity of earthenware ducts	1.2 K.m/W

Current rating de-rating factors for other than 30°C ambient air temperature.

Air Temperature	20	25	35	40	45	50	55	60
De-rating factor	1.08	1.04	0.96	0.91	0.87	0.82	0.76	0.71

Current rating de-rating factors for other than 20°C ground temperature.

Ground Temperature	10	15	25	30	35	40	45	50
De-rating factor	1.07	1.04	0.96	0.93	0.89	0.85	0.8	0.76

POLYCAB MV CU IEC 60502-2 12/20 KV
Medium Voltage Copper Armoured Cable, 12/20 (24) KV AC

Single Core



Three Core



Outstanding Features

- Flame retardant
- High life
- UV resistant
- Oil resistant

Application

POLYCAB MV 12/20 KV XLPE insulated with copper conductor single & multi core cable is suitable to use for power networks, underground and in cable ducting.

Voltage Rating

Nominal Voltage: 12/20 kV

Operation Temperature

Max. operating temperature: +90°C
 Max. Short Circuit Temperature: 250°C

Construction

- Conductor: Circular Compacted Copper conductor as per IEC 60228, class 2
- Conductor Screen: Extruded Semi-conductive compound
- Insulation: XLPE
- Non-Metallic Insulation Screen: Extruded Semi-conductive compound
- Metallic Insulation Screen: Copper tape screen
- Inner Sheath: Extruded Polyvinyl Chloride
- Armour:
 - Single Core: Aluminium Round Wire Armoured (AWA)
 - Multi Core: Galvanised Steel Round Wire (SWA)
- Outer Sheath: Extruded Polyvinyl Chloride, Colour: Black

Bending Radius:

Fixed Installation: 12D
 D is overall diameter of cable

Standard and References:

IEC 60228
 IEC 60502-2
 BS 6622

Test Voltage

42kV AC 50 Hz

Impulse Test Voltage

Peak 125kV AC

Compliance

- Conductor resistance IEC 60228
- Insulation resistance IEC 60502-2
- Flammability test IEC 60332-1-2
- Partial Discharge test IEC 60502-2



OUR CERTIFICATION
 ISO 9001 | ISO 14001 | ISO 45001



OUR CERTIFICATION
 ISO 9001 | ISO 14001 | ISO 45001



DIMENSIONAL CHARACTERISTICS:

Product Code	No. of Cores	Core Cross sectional Area	Nominal Diameter			Weight (Approx.) Kg/Km
	No.		mm ²	Under armour	Over armour	
		mm		mm	mm	
MVIE20CXAWY2001C050SA001P	1	50	23.8	27.0	31.0	1500
MVIE20CXAWY2001C070SA001P	1	70	25.4	29.4	33.0	1800
MVIE20CXAWY2001C095SA001P	1	95	27.2	31.2	35.0	2100
MVIE20CXAWY2001C120SA001P	1	120	28.8	32.8	37.0	2400
MVIE20CXAWY2001C150SA001P	1	150	30.5	34.5	39.0	2800
MVIE20CXAWY2001C185SA001P	1	185	32.2	36.2	41.0	3200
MVIE20CXAWY2001C240SA001P	1	240	34.6	38.6	43.0	3800
MVIE20CXAWY2001C300SA001P	1	300	37.3	42.3	47.0	4700
MVIE20CXAWY2001C400SA001P	1	400	40.5	45.5	51.0	5700
MVIE20CXAWY2001C500SA001P	1	500	44.0	49.0	54.0	6950
MVIE20CXAWY2001C630SA001P	1	630	47.4	52.4	58.0	8300
MVIE20CXAWY2001C800SA001P	1	800	51.7	56.7	63.0	10100
MVIE20CXAWY2001C01KSA001P	1	1000	56.2	61.2	67.0	12200
MVIE20CXSWY2003C050SA001P	3	50	49.6	54.6	60.0	6350
MVIE20CXSWY2003C070SA001P	3	70	53.1	58.1	64.0	7350
MVIE20CXSWY2003C095SA001P	3	95	57.1	62.1	69.0	8550
MVIE20CXSWY2003C120SA001P	3	120	60.5	66.8	73.0	10500
MVIE20CXSWY2003C150SA001P	3	150	64.4	70.7	78.0	11900
MVIE20CXSWY2003C185SA001P	3	185	68.2	74.5	82.0	13450
MVIE20CXSWY2003C240SA001P	3	240	73.8	80.1	88.0	15800
MVIE20CXSWY2003C300SA001P	3	300	79.2	85.5	93.0	18400
MVIE20CXSWY2003C400SA001P	3	400	86.5	92.8	101.0	22050

ELECTRICAL CHARACTERISTICS:

No. of Cores	Core Cross sectional Area mm ²	Max. DC Resistance at 20°C Ω/km	Max. AC Resistance at 90°C Ω/km	Approx. Capacitance μF/km	Approx. Inductance mH/km	Approx. Reactance Ω/km	Continuous Current Rating					
							In ground at 20°C		In Ducts		In air at 30°C	
							Flat	Trefoil	Flat	Trefoil	Flat	Trefoil
No.							Amps					
1	50	0.387	0.494	0.17	0.44	0.14	203	196	188	186	243	238
1	70	0.268	0.342	0.19	0.42	0.13	246	239	229	227	303	296
1	95	0.193	0.247	0.21	0.40	0.13	293	285	274	271	369	361
1	120	0.153	0.196	0.23	0.38	0.12	332	323	311	308	426	417
1	150	0.124	0.159	0.25	0.37	0.12	366	361	347	343	481	473
1	185	0.0991	0.127	0.27	0.36	0.11	410	406	391	387	550	543
1	240	0.0754	0.097	0.30	0.34	0.11	470	469	453	447	647	641
1	300	0.0601	0.078	0.33	0.34	0.11	524	526	510	504	739	735
1	400	0.0470	0.062	0.37	0.33	0.10	572	590	571	564	837	845
1	500	0.0366	0.052	0.44	0.26	0.08	660	655	640	635	970	960
1	630	0.0283	0.042	0.48	0.26	0.08	735	730	715	710	1110	1100
1	800	0.0221	0.036	0.53	0.25	0.08	770	820	800	790	1260	1250
1	1000	0.0176	0.032	0.59	0.24	0.07	825	885	865	855	1420	1410

No. of Cores	Core Cross sectional Area mm ²	Max. DC Resistance at 20°C Ω/km	Max. AC Resistance at 90°C Ω/km	Approx. Capacitance μF/km	Approx. Inductance mH/km	Approx. Reactance Ω/km	Continuous Current Rating			
							In ground at 20°C		In Ducts	In air at 30°C
							Amps			
No.										
3	50	0.387	0.494	0.17	0.37	0.12	181	158	205	
3	70	0.268	0.342	0.19	0.35	0.11	220	194	253	
3	95	0.193	0.247	0.21	0.34	0.11	263	232	307	
3	120	0.153	0.196	0.23	0.32	0.10	298	264	352	
3	150	0.124	0.159	0.25	0.31	0.10	332	296	397	
3	185	0.0991	0.127	0.27	0.30	0.10	374	335	453	
3	240	0.0754	0.097	0.30	0.29	0.09	431	387	529	
3	300	0.0601	0.078	0.33	0.28	0.09	482	435	599	
3	400	0.0470	0.062	0.37	0.27	0.09	541	492	683	

Maximum conductor temperature 90°C
Ambient air temperature 30°C
Ground temperature 20°C
Depth of laying 0.8 m
Thermal resistivity of soil 1.5 K.m/W
Thermal resistivity of earthenware ducts 1.2 K.m/W

Current rating de-rating factors for other than 30°C ambient air temperature.

Air Temperature	20	25	35	40	45	50	55	60
De-rating factor	1.08	1.04	0.96	0.91	0.87	0.82	0.76	0.71

Current rating de-rating factors for other than 20°C ground temperature.

Ground Temperature	10	15	25	30	35	40	45	50
De-rating factor	1.07	1.04	0.96	0.93	0.89	0.85	0.8	0.76



POLYCAB MV CU IEC 60502-2 18/30 KV
Medium Voltage Copper Armoured Cable, 18/30 (36) KV AC

Single Core



Three Core



Outstanding Features

- Flame retardant
- High life
- UV resistant
- Oil resistant

Application

POLYCAB medium voltage power cables are for power networks, underground, in cable ducting and also suitable for direct burial.

Voltage Rating

Nominal Voltage: 18/30 kV

Operation Temperature

Max. operating temperature: +90°C
Max. Short Circuit Temperature: 250°C

Construction

- Conductor: Circular Compacted Copper conductor as per IEC 60228, class 2
- Conductor Screen: Extruded Semi-conductive compound
- Insulation: XLPE
- Non-Metallic Insulation Screen: Extruded Semi-conductive compound
- Metallic Insulation Screen: Copper tape screen
- Inner Sheath: Extruded Polyvinyl Chloride
- Armour:
 - Single Core: Aluminium Round Wire Armoured (AWA)
 - Multi Core: Galvanised Steel Round Wire (SWA)
- Outer Sheath: Extruded Polyvinyl Chloride, Colour: Black

Standard and References:

IEC 60228
IEC 60502-2
BS 6622

Test Voltage

63kV AC 50 Hz

Impulse Test Voltage

Peak 170kV AC

Compliance

- Conductor resistance IEC 60228
- Insulation resistance IEC 60502-2
- Flammability test IEC 60332-1-2
- Partial Discharge test IEC 60502-2



Bending Radius:

Fixed Installation: 12D
D is overall diameter of cable

POLYCAB MV CU IEC 60502-2 18/30 KV
Medium Voltage Copper Armoured Cable, 18/30 (36) KV AC

DIMENSIONAL CHARACTERISTICS:

Product Code	No. of Cores	Core Cross sectional Area	Nominal Diameter			Weight (Approx.) Kg/Km
			Under armour mm	Over armour mm	Overall mm	
	No.	mm ²	mm	mm	mm	
MVIE19CXAWY2001C050SA001P	1	50	28.8	32.8	37.0	1900
MVIE19CXAWY2001C070SA001P	1	70	30.4	34.4	39.0	2150
MVIE19CXAWY2001C095SA001P	1	95	32.2	36.2	41.0	2500
MVIE19CXAWY2001C120SA001P	1	120	33.8	37.8	42.0	2850
MVIE19CXAWY2001C150SA001P	1	150	35.7	40.7	46.0	3400
MVIE19CXAWY2001C185SA001P	1	185	37.4	42.4	47.0	3800
MVIE19CXAWY2001C240SA001P	1	240	39.8	44.8	50.0	4450
MVIE19CXAWY2001C300SA001P	1	300	42.5	47.5	53.0	5250
MVIE19CXAWY2001C400SA001P	1	400	45.7	50.7	56.0	6300
MVIE19CXAWY2001C500SA001P	1	500	49.2	54.2	60.0	7550
MVIE19CXAWY2001C630SA001P	1	630	52.6	57.6	63.0	8950
MVIE19CXAWY2001C800SA001P	1	800	56.9	61.9	68.0	10800
MVIE19CXAWY2001C01KSA001P	1	1000	61.4	66.4	73.0	12950
MVIE19CXSWY2003C050SA001P	3	50	60.8	67.1	74.0	8950
MVIE19CXSWY2003C070SA001P	3	70	64.3	70.6	78.0	10050
MVIE19CXSWY2003C095SA001P	3	95	68.3	74.6	82.0	11400
MVIE19CXSWY2003C120SA001P	3	120	71.9	78.2	86.0	12650
MVIE19CXSWY2003C150SA001P	3	150	75.6	81.9	90.0	14150
MVIE19CXSWY2003C185SA001P	3	185	79.4	85.7	94.0	15750
MVIE19CXSWY2003C240SA001P	3	240	85.0	91.3	100.0	18250
MVIE19CXSWY2003C300SA001P	3	300	90.6	96.9	106.0	21050
MVIE19CXSWY2003C400SA001P	3	400	97.7	104.0	113.0	24900



POLYCAB MV CU IEC 60502-2 18/30 KV
Medium Voltage Copper Armoured Cable, 18/30 (36) KV AC

ELECTRICAL CHARACTERISTICS:

No. of Cores	Core Cross sectional Area mm ²	Max. DC Resistance at 20°C Ω/km	Max. AC Resistance at 90°C Ω/km	Approx. Capacitance μF/km	Approx. Inductance mH/km	Approx. Reactance Ω/km	Continuous Current Rating					
							In ground at 20°C		In Ducts		In air at 30°C	
							Flat	Trefoil	Flat	Trefoil	Flat	Trefoil
No.	mm ²	Ω/km	Ω/km	μF/km	mH/km	Ω/km	Amps					
1	50	0.387	0.494	0.13	0.47	0.15	203	196	188	186	243	238
1	70	0.268	0.342	0.15	0.45	0.14	246	239	229	227	303	296
1	95	0.193	0.247	0.16	0.43	0.14	293	285	274	271	369	361
1	120	0.153	0.196	0.18	0.41	0.13	332	323	311	308	426	417
1	150	0.124	0.159	0.19	0.40	0.13	366	361	347	343	481	473
1	185	0.0991	0.127	0.21	0.39	0.12	410	406	391	387	550	543
1	240	0.0754	0.097	0.23	0.37	0.12	470	469	453	447	647	641
1	300	0.0601	0.078	0.25	0.36	0.11	524	526	510	504	739	735
1	400	0.0470	0.062	0.28	0.35	0.11	572	590	571	564	837	845
1	500	0.0366	0.052	0.32	0.28	0.09	660	655	640	635	970	960
1	630	0.0283	0.042	0.35	0.27	0.09	735	730	715	710	1110	1100
1	800	0.0221	0.036	0.39	0.26	0.08	770	820	800	790	1260	1250
1	1000	0.0176	0.032	0.42	0.25	0.08	825	885	865	855	1420	1410

No. of Cores	Core Cross sectional Area mm ²	Max. DC Resistance at 20°C Ω/km	Max. AC Resistance at 90°C Ω/km	Approx. Capacitance μF/km	Approx. Inductance mH/km	Approx. Reactance Ω/km	Continuous Current Rating		
							In ground at 20°C		In air at 30°C
							Amps		
3	50	0.387	0.494	0.13	0.41	0.13	181	158	205
3	70	0.268	0.342	0.15	0.39	0.12	220	194	253
3	95	0.193	0.247	0.16	0.37	0.12	263	232	307
3	120	0.153	0.196	0.18	0.36	0.11	298	264	352
3	150	0.124	0.159	0.19	0.35	0.11	332	296	397
3	185	0.0991	0.127	0.21	0.34	0.11	374	335	453
3	240	0.0754	0.097	0.23	0.32	0.10	431	387	529
3	300	0.0601	0.078	0.25	0.31	0.10	482	435	599
3	400	0.0470	0.062	0.28	0.30	0.09	541	492	683

Maximum conductor temperature	90°C
Ambient air temperature	30°C
Ground temperature	20°C
Depth of laying	0.8 m
Thermal resistivity of soil	1.5 K.m/W
Thermal resistivity of earthenware ducts	1.2 K.m/W

Current rating de-rating factors for other than 30°C ambient air temperature.

Air Temperature	20	25	35	40	45	50	55	60
De-rating factor	1.08	1.04	0.96	0.91	0.87	0.82	0.76	0.71

Current rating de-rating factors for other than 20°C ground temperature.

Ground Temperature	10	15	25	30	35	40	45	50
De-rating factor	1.07	1.04	0.96	0.93	0.89	0.85	0.8	0.76



OUR CERTIFICATION
ISO 9001 | **ISO 14001** | **ISO 45001**



POLYCAB MV AL IEC 60502-2 3.6/6 KV
Medium Voltage Aluminium Armoured Cable, 3.6/6 (7.2) KV AC

Single Core



Three Core



Outstanding Features

- Flame retardant
- High life
- UV resistant
- Oil resistant

Application

POLYCAB MV 3.6/6 KV XLPE insulated with Aluminium conductor single & multi core cable is suitable to use for power distribution for external and direct burial applications in power network system.

Voltage Rating

Nominal Voltage: 3.6/6 kV

Operation Temperature

Max. operating temperature: +90°C
 Max. Short Circuit Temperature: 250°C

Construction

- Conductor: Circular Compacted Aluminium conductor as per IEC 60228, class 2
- Conductor Screen: Extruded Semi-conductive compound
- Insulation: XLPE
- Non-Metallic Insulation Screen: Extruded Semi-conductive compound
- Metallic Insulation Screen: Copper tape screen
- Inner Sheath: Extruded Polyvinyl Chloride
- Armour:
 Single Core: Aluminium Round Wire Armoured (AWA)
 Multi Core: Galvanised Steel Round Wire (SWA)
- Outer Sheath: Extruded Polyvinyl Chloride, Colour: Black

Standard and References:

IEC 60228
 IEC 60502-2
 BS 6622

Test Voltage

12.5kV AC 50 Hz

Impulse Test Voltage

Peak 60kV AC

Compliance

- Conductor resistance IEC 60228
- Insulation resistance IEC 60502-2
- Flammability test IEC 60332-1-2
- Partial Discharge test IEC 60502-2



Bending Radius:

Fixed Installation: 12D
 D is overall diameter of cable



OUR CERTIFICATION
ISO 9001 | **ISO 14001** | **ISO 45001**



DIMENSIONAL CHARACTERISTICS:

Product Code	No. of Cores	Core Cross sectional Area	Nominal Diameter			Weight (Approx.)
			Under armour	Over armour	Overall	
	No.	mm ²	mm	mm	mm	Kg/Km
MVIE21AXAWY2001C035SA001P	1	35	16.3	19.5	23	650
MVIE21AXAWY2001C050SA001P	1	50	17.8	21.0	25	750
MVIE21AXAWY2001C070SA001P	1	70	19.4	22.6	27	900
MVIE21AXAWY2001C095SA001P	1	95	21.2	24.4	29	1050
MVIE21AXAWY2001C120SA001P	1	120	22.8	26.0	30	1150
MVIE21AXAWY2001C150SA001P	1	150	24.5	27.7	32	1350
MVIE21AXAWY2001C185SA001P	1	185	26.2	30.2	35	1550
MVIE21AXAWY2001C240SA001P	1	240	28.8	32.8	37	1850
MVIE21AXAWY2001C300SA001P	1	300	31.7	35.7	40	2150
MVIE21AXAWY2001C400SA001P	1	400	35.3	39.3	44	2600
MVIE21AXAWY2001C500SA001P	1	500	39.2	44.2	49	3300
MVIE21AXAWY2001C630SA001P	1	630	42.9	47.9	53	3850
MVIE21AXAWY2001C800SA001P	1	800	46.9	51.9	57	4550
MVIE21AXAWY2001C01KSA001P	1	1000	51.2	56.2	62	5400
MVIE21AXSWY2003C035SA001P	3	35	32.6	36.6	41	2750
MVIE21AXSWY2003C050SA001P	3	50	36.1	41.1	46	3550
MVIE21AXSWY2003C070SA001P	3	70	39.7	44.7	50	4100
MVIE21AXSWY2003C095SA001P	3	95	43.6	48.6	54	4700
MVIE21AXSWY2003C120SA001P	3	120	47.1	52.1	58	5350
MVIE21AXSWY2003C150SA001P	3	150	50.9	55.9	62	6000
MVIE21AXSWY2003C185SA001P	3	185	54.7	59.7	66	6700
MVIE21AXSWY2003C240SA001P	3	240	60.6	65.6	72	7950
MVIE21AXSWY2003C300SA001P	3	300	67.1	73.4	80	10200
MVIE21AXSWY2003C400SA001P	3	400	75.3	81.6	89	12250

ELECTRICAL CHARACTERISTICS:

No. of Cores	Core Cross sectional Area	Max. DC Resistance at 20°C	Max. AC Resistance at 90°C	Approx. Capacitance	Approx. Inductance	Approx. Reactance	Continuous Current Rating					
							In ground at 20°C		In Ducts		In air at 30°C	
							Flat	Trefoil	Flat	Trefoil	Flat	Trefoil
No.	mm ²	Ω/km	Ω/km	μF/km	mH/km	Ω/km	Amps					
1	35	0.868	1.113	0.25	0.42	0.13	134	129	123	122	157	154
1	50	0.641	0.822	0.29	0.39	0.12	157	152	146	142	189	184
1	70	0.443	0.568	0.33	0.37	0.12	192	186	178	176	236	230
1	95	0.320	0.410	0.38	0.36	0.11	229	221	213	210	287	280
1	120	0.253	0.325	0.41	0.34	0.11	260	252	242	240	332	324
1	150	0.206	0.264	0.46	0.33	0.10	288	281	271	267	376	368
1	185	0.164	0.211	0.50	0.33	0.10	324	317	307	303	432	424
1	240	0.125	0.161	0.54	0.31	0.10	373	367	356	351	511	502
1	300	0.100	0.129	0.57	0.31	0.10	419	414	402	397	586	577
1	400	0.0778	0.101	0.61	0.30	0.09	466	470	457	451	676	673
1	500	0.0605	0.080	0.71	0.24	0.08	525	530	510	505	760	750
1	630	0.0469	0.063	0.78	0.24	0.07	580	585	560	555	860	850
1	800	0.0367	0.051	0.87	0.23	0.07	650	655	620	615	960	950
1	1000	0.0291	0.042	0.96	0.22	0.07	715	705	670	665	1060	1050

No. of Cores	Core Cross sectional Area	Max. DC Resistance at 20°C	Max. AC Resistance at 90°C	Approx. Capacitance	Approx. Inductance	Approx. Reactance	Continuous Current Rating		
							In ground at 20°C	In Ducts	In air at 30°C
							Amps		
No.	mm ²	Ω/km	Ω/km	μF/km	mH/km	Ω/km	Amps		
3	35	0.868	1.113	0.25	0.42	0.090	119	103	132
3	50	0.641	0.822	0.29	0.32	0.096	140	122	158
3	70	0.443	0.568	0.33	0.30	0.092	171	150	196
3	95	0.320	0.410	0.38	0.29	0.088	203	179	236
3	120	0.253	0.325	0.41	0.28	0.085	232	205	273
3	150	0.206	0.264	0.46	0.27	0.083	260	231	309
3	185	0.164	0.211	0.50	0.26	0.081	294	262	355
3	240	0.125	0.161	0.54	0.26	0.079	340	305	415
3	300	0.100	0.129	0.57	0.25	0.078	384	346	475
3	400	0.0778	0.101	0.61	0.25	0.077	438	398	552

Maximum conductor temperature 90°C
 Ambient air temperature 30°C
 Ground temperature 20°C
 Depth of laying 0.8 m
 Thermal resistivity of soil 1.5 K.m/W
 Thermal resistivity of earthenware ducts 1.2 K.m/W

Current rating de-rating factors for other than 30°C ambient air temperature.

Air Temperature	20	25	35	40	45	50	55	60
De-rating factor	1.08	1.04	0.96	0.91	0.87	0.82	0.76	0.71

Current rating de-rating factors for other than 20°C ground temperature.

Ground Temperature	10	15	25	30	35	40	45	50
De-rating factor	1.07	1.04	0.96	0.93	0.89	0.85	0.8	0.76



OUR CERTIFICATION
 ISO 9001 | ISO 14001 | ISO 45001



OUR CERTIFICATION
 ISO 9001 | ISO 14001 | ISO 45001



POLYCAB MV AL IEC 60502-2 6/10 KV
Medium Voltage Aluminium Armoured Cable, 6/10 (12) KV AC

Single Core



Three Core



Outstanding Features

- Flame retardant
- High life
- UV resistant
- Oil resistant

Application

POLYCAB MV 6/10 KV XLPE insulated with Aluminium conductor single & multi core cable is suitable to use for power networks, underground and in cable ducting.

Voltage Rating

Nominal Voltage: 6/10 kV

Operation Temperature

Max. operating temperature: +90°C
Max. Short Circuit Temperature: 250°C

Construction

- Conductor: Circular Compacted Aluminium conductor as per IEC 60228, class 2
- Conductor Screen: Extruded Semi-conductive compound
- Insulation: XLPE
- Non-Metallic Insulation Screen: Extruded Semi-conductive compound
- Metallic Insulation Screen: Copper tape screen
- Inner Sheath: Extruded Polyvinyl Chloride
- Armour:
 - Single Core: Aluminium Round Wire Armoured (AWA)
 - Multi Core: Galvanised Steel Round Wire (SWA)
- Outer Sheath: Extruded Polyvinyl Chloride, Colour: Black

Standard and References:

IEC 60228
IEC 60502-2
BS 6622

Test Voltage

21kV AC 50 Hz

Impulse Test Voltage

Peak 170kV AC

Compliance

- Conductor resistance IEC 60228
- Insulation resistance IEC 60502-2
- Flammability test IEC 60332-1-2
- Fire Retardant IEC 60332-3-22
- Partial Discharge test IEC 60502-2



Bending Radius:

Fixed Installation: 12D
D is overall diameter of cable

POLYCAB MV AL IEC 60502-2 6/10 KV
Medium Voltage Aluminium Armoured Cable, 6/10 (12) KV AC

DIMENSIONAL CHARACTERISTICS:

Product Code	No. of Cores	Core Cross sectional Area	Nominal Diameter			Weight (Approx.) Kg/Km
			Under armour mm	Over armour mm	Overall mm	
MVIE22AXAWY2001C050SA001P	1	50	19.6	22.8	26.0	850
MVIE22AXAWY2001C070SA001P	1	70	21.2	24.4	28.0	1000
MVIE22AXAWY2001C095SA001P	1	95	23.0	26.2	30.0	1150
MVIE22AXAWY2001C120SA001P	1	120	24.6	27.8	32.0	1300
MVIE22AXAWY2001C150SA001P	1	150	26.3	30.3	35.0	1550
MVIE22AXAWY2001C185SA001P	1	185	28.0	32.0	36.0	1700
MVIE22AXAWY2001C240SA001P	1	240	30.4	34.4	39.0	1950
MVIE22AXAWY2001C300SA001P	1	300	32.9	36.9	41.0	2250
MVIE22AXAWY2001C400SA001P	1	400	36.1	40.1	45.0	2700
MVIE22AXAWY2001C500SA001P	1	500	39.6	44.6	50.0	3350
MVIE22AXAWY2001C630SA001P	1	630	43.2	48.2	54.0	3900
MVIE22AXAWY2001C800SA001P	1	800	47.3	52.3	58.0	4600
MVIE22AXAWY2001C01KSA001P	1	1000	51.8	56.8	63.0	5450
MVIE22AXSWY2003C050SA001P	3	50	40.2	45.2	50.0	4100
MVIE22AXSWY2003C070SA001P	3	70	43.6	48.6	54.0	4600
MVIE22AXSWY2003C095SA001P	3	95	47.7	52.7	59.0	5300
MVIE22AXSWY2003C120SA001P	3	120	51.2	56.2	62.0	5950
MVIE22AXSWY2003C150SA001P	3	150	55.0	60.0	66.0	6650
MVIE22AXSWY2003C185SA001P	3	185	58.8	63.8	70.0	7400
MVIE22AXSWY2003C240SA001P	3	240	64.3	70.6	77.0	9450
MVIE22AXSWY2003C300SA001P	3	300	69.9	76.2	83.0	10750
MVIE22AXSWY2003C400SA001P	3	400	77.0	83.3	91.0	12600



POLYCAB MV AL IEC 60502-2 6/10 KV
Medium Voltage Aluminium Armoured Cable, 6/10 (12) KV AC

ELECTRICAL CHARACTERISTICS:

No. of Cores	Core Cross sectional Area mm ²	Max. DC Resistance at 20°C Ω/km	Max. AC Resistance at 90°C Ω/km	Approx. Capacitance μF/km	Approx. Inductance mH/km	Approx. Reactance Ω/km	Continuous Current Rating					
							In ground at 20°C		In Ducts		In air at 30°C	
							Flat	Trefoil	Flat	Trefoil	Flat	Trefoil
No.	mm ²	Ω/km	Ω/km	μF/km	mH/km	Ω/km	Amps					
1	50	0.641	0.822	0.23	0.41	0.13	157	152	146	142	189	184
1	70	0.443	0.568	0.26	0.39	0.12	192	186	178	176	236	230
1	95	0.320	0.410	0.30	0.37	0.12	229	221	213	210	287	280
1	120	0.253	0.325	0.33	0.35	0.11	260	252	242	240	332	324
1	150	0.206	0.264	0.36	0.35	0.11	288	281	271	267	376	368
1	185	0.164	0.211	0.39	0.34	0.11	324	317	307	303	432	424
1	240	0.125	0.161	0.44	0.32	0.10	373	367	356	351	511	502
1	300	0.100	0.129	0.49	0.31	0.10	419	414	402	397	586	577
1	400	0.0778	0.101	0.55	0.30	0.09	466	470	457	451	676	673
1	500	0.0605	0.080	0.67	0.25	0.08	525	530	510	505	760	750
1	630	0.0469	0.063	0.74	0.24	0.08	580	585	560	555	860	850
1	800	0.0367	0.051	0.82	0.23	0.07	650	655	620	615	960	950
1	1000	0.0291	0.042	0.91	0.22	0.07	715	705	670	665	1060	1050

No. of Cores	Core Cross sectional Area mm ²	Max. DC Resistance at 20°C Ω/km	Max. AC Resistance at 90°C Ω/km	Approx. Capacitance μF/km	Approx. Inductance mH/km	Approx. Reactance Ω/km	Continuous Current Rating		
							In ground at 20°C	In Ducts	In air at 30°C
							Amps		
No.	mm ²	Ω/km	Ω/km	μF/km	mH/km	Ω/km	Amps		
3	50	0.641	0.822	0.23	0.33	0.10	140	122	158
3	70	0.443	0.568	0.26	0.31	0.10	171	150	196
3	95	0.320	0.410	0.30	0.30	0.09	203	179	236
3	120	0.253	0.325	0.33	0.29	0.09	232	205	273
3	150	0.206	0.264	0.36	0.28	0.09	260	231	309
3	185	0.164	0.211	0.39	0.27	0.09	294	262	355
3	240	0.125	0.161	0.44	0.26	0.08	340	305	415
3	300	0.100	0.129	0.49	0.26	0.08	384	346	475
3	400	0.0778	0.101	0.55	0.25	0.08	438	398	552

Maximum conductor temperature 90°C
 Ambient air temperature 30°C
 Ground temperature 20°C
 Depth of laying 0.8 m
 Thermal resistivity of soil 1.5 K.m/W
 Thermal resistivity of earthenware ducts 1.2 K.m/W

Current rating de-rating factors for other than 30°C ambient air temperature.

Air Temperature	20	25	35	40	45	50	55	60
De-rating factor	1.08	1.04	0.96	0.91	0.87	0.82	0.76	0.71

Current rating de-rating factors for other than 20°C ground temperature.

Ground Temperature	10	15	25	30	35	40	45	50
De-rating factor	1.07	1.04	0.96	0.93	0.89	0.85	0.8	0.76

POLYCAB MV AL IEC 60502-2 8.7/15 KV
Medium Voltage Aluminium Armoured Cable, 8.7/15 (17.5) KV AC

Single Core



Three Core



Outstanding Features

- Flame retardant
- High life
- UV resistant
- Oil resistant

Application

POLYCAB MV 8.7/15 KV XLPE insulated with Aluminium conductor single & multi core cable is suitable to use for power networks, underground and in cable ducting.

Voltage Rating

Nominal Voltage: 8.7/15 kV

Operation Temperature

Max. operating temperature: +90°C
 Max. Short Circuit Temperature: 250°C

Construction

- Conductor: Circular Compacted Aluminium conductor as per IEC 60228, class 2
- Conductor Screen: Extruded Semi-conductive compound
- Insulation: XLPE
- Non-Metallic Insulation Screen: Extruded Semi-conductive compound
- Metallic Insulation Screen: Copper tape screen
- Inner Sheath: Extruded Polyvinyl Chloride
- Armour:
 Single Core: Aluminium Round Wire Armoured (AWA)
 Multi Core: Galvanised Steel Round Wire (SWA)
- Outer Sheath: Extruded Polyvinyl Chloride, Colour: Black

Bending Radius:

Fixed Installation: 12D
 D is overall diameter of cable

Standard and References:

IEC 60228
 IEC 60502-2
 BS 6622

Test Voltage

30.5kV AC 50Hz

Impulse Test Voltage

Peak 95kV AC

Compliance

- Conductor resistance IEC 60228
- Insulation resistance IEC 60502-2
- Flammability test IEC 60332-1-2
- Partial Discharge test IEC 60502-2



OUR CERTIFICATION
 ISO 9001 | ISO 14001 | ISO 45001



OUR CERTIFICATION
 ISO 9001 | ISO 14001 | ISO 45001



DIMENSIONAL CHARACTERISTICS:

Product Code	No. of Cores	Core Cross sectional Area	Nominal Diameter			Weight (Approx.)
			Under armour	Over armour	Overall	
	No.	mm ²	mm	mm	mm	Kg/Km
MVIE23AXAWY2001C050SA001P	1	50	21.8	25.0	29.0	1000
MVIE23AXAWY2001C070SA001P	1	70	23.4	26.6	30.0	1100
MVIE23AXAWY2001C095SA001P	1	95	25.2	29.2	33.0	1350
MVIE23AXAWY2001C120SA001P	1	120	26.8	30.8	35.0	1550
MVIE23AXAWY2001C150SA001P	1	150	28.5	32.5	37.0	1700
MVIE23AXAWY2001C185SA001P	1	185	30.2	34.2	39.0	1900
MVIE23AXAWY2001C240SA001P	1	240	32.6	36.6	41.0	2150
MVIE23AXAWY2001C300SA001P	1	300	35.1	39.1	44.0	2450
MVIE23AXAWY2001C400SA001P	1	400	38.5	43.5	49.0	3100
MVIE23AXAWY2001C500SA001P	1	500	41.8	46.8	52.0	3550
MVIE23AXAWY2001C630SA001P	1	630	45.4	50.4	56.0	4150
MVIE23AXAWY2001C800SA001P	1	800	49.7	54.7	60.0	4900
MVIE23AXAWY2001C01KSA001P	1	1000	54.2	59.2	65.0	5800
MVIE23AXSWY2003C050SA001P	3	50	40.2	45.2	50.0	4750
MVIE23AXSWY2003C070SA001P	3	70	43.6	48.6	54.0	5350
MVIE23AXSWY2003C095SA001P	3	95	47.7	52.7	59.0	6050
MVIE23AXSWY2003C120SA001P	3	120	51.2	56.2	62.0	6700
MVIE23AXSWY2003C150SA001P	3	150	55.0	60.0	66.0	7450
MVIE23AXSWY2003C185SA001P	3	185	58.8	63.8	70.0	9050
MVIE23AXSWY2003C240SA001P	3	240	64.3	70.6	77.0	10400
MVIE23AXSWY2003C300SA001P	3	300	69.9	76.2	83.0	11750
MVIE23AXSWY2003C400SA001P	3	400	77.0	83.3	91.0	13700

ELECTRICAL CHARACTERISTICS:

No. of Cores	Core Cross sectional Area	Max. DC Resistance at 20°C	Max. AC Resistance at 90°C	Approx. Capacitance	Approx. Inductance	Approx. Reactance	Continuous Current Rating					
							In ground at 20°C		In Ducts		In air at 30°C	
							Flat	Trefoil	Flat	Trefoil	Flat	Trefoil
No.	mm ²	Ω/km	Ω/km	μF/km	mH/km	Ω/km	Amps					
1	50	0.641	0.822	0.19	0.42	0.13	157	152	146	142	189	184
1	70	0.443	0.568	0.22	0.40	0.13	192	186	178	176	236	230
1	95	0.320	0.410	0.24	0.39	0.12	229	221	213	210	287	280
1	120	0.253	0.325	0.27	0.37	0.12	260	252	242	240	332	324
1	150	0.206	0.264	0.29	0.36	0.11	288	281	271	267	376	368
1	185	0.164	0.211	0.32	0.35	0.11	324	317	307	303	432	424
1	240	0.125	0.161	0.35	0.34	0.11	373	367	356	351	511	502
1	300	0.100	0.129	0.39	0.32	0.10	419	414	402	397	586	577
1	400	0.0778	0.101	0.44	0.32	0.10	466	470	457	451	676	673
1	500	0.0605	0.080	0.52	0.26	0.08	525	530	510	505	760	750
1	630	0.0469	0.063	0.57	0.25	0.08	580	585	560	555	860	850
1	800	0.0367	0.051	0.64	0.24	0.07	650	655	620	615	960	950
1	1000	0.0291	0.042	0.70	0.23	0.07	715	705	670	665	1060	1050

No. of Cores	Core Cross sectional Area	Max. DC Resistance at 20°C	Max. AC Resistance at 90°C	Approx. Capacitance	Approx. Inductance	Approx. Reactance	Continuous Current Rating				
							In ground at 20°C		In Ducts		In air at 30°C
No.	mm ²	Ω/km	Ω/km	μF/km	mH/km	Ω/km	Amps				
3	50	0.641	0.822	0.19	0.35	0.11	140	122	158		
3	70	0.443	0.568	0.22	0.34	0.11	171	150	196		
3	95	0.320	0.410	0.24	0.32	0.10	203	179	236		
3	120	0.253	0.325	0.27	0.31	0.10	232	205	273		
3	150	0.206	0.264	0.29	0.30	0.09	260	231	309		
3	185	0.164	0.211	0.32	0.29	0.09	294	262	355		
3	240	0.125	0.161	0.35	0.28	0.09	340	305	415		
3	300	0.100	0.129	0.39	0.27	0.09	384	346	475		
3	400	0.0778	0.101	0.44	0.26	0.08	438	398	552		

Maximum conductor temperature 90°C
 Ambient air temperature 30°C
 Ground temperature 20°C
 Depth of laying 0.8 m
 Thermal resistivity of soil 1.5 K.m/W
 Thermal resistivity of earthenware ducts 1.2 K.m/W

Current rating de-rating factors for other than 30°C ambient air temperature.

Air Temperature	20	25	35	40	45	50	55	60
De-rating factor	1.08	1.04	0.96	0.91	0.87	0.82	0.76	0.71

Current rating de-rating factors for other than 20°C ground temperature.

Ground Temperature	10	15	25	30	35	40	45	50
De-rating factor	1.07	1.04	0.96	0.93	0.89	0.85	0.8	0.76



OUR CERTIFICATION
ISO 9001 | ISO 14001 | ISO 45001



OUR CERTIFICATION
ISO 9001 | ISO 14001 | ISO 45001



POLYCAB MV AL IEC 60502-2 12/20 KV
Medium Voltage Aluminium Armoured Cable, 12/20 (24) KV AC

Single Core



Three Core



Outstanding Features

- Flame retardant
- High life
- UV resistant
- Oil resistant

Application

POLYCAB MV 12/20 KV XLPE insulated with Aluminium conductor single & multi core cable is suitable to use for power networks, underground and in cable ducting.

Voltage Rating

Nominal Voltage: 12/20 kV

Operation Temperature

Max. operating temperature: +90°C
Max. Short Circuit Temperature: 250°C

Construction

- Conductor: Circular Compacted Aluminium conductor as per IEC 60228, class 2
- Conductor Screen: Extruded Semi-conductive compound
- Insulation: XLPE
- Non-Metallic Insulation Screen: Extruded Semi-conductive compound
- Metallic Insulation Screen: Copper tape screen
- Inner Sheath: Extruded Polyvinyl Chloride
- Armour:
 - Single Core: Aluminium Round Wire Armoured (AWA)
 - Multi Core: Galvanised Steel Round Wire (SWA)
- Outer Sheath: Extruded Polyvinyl Chloride, Colour: Black

Standard and References:

IEC 60228
IEC 60502-2
BS 6622

Test Voltage

42kV AC 50 Hz

Impulse Test Voltage

Peak 125kV AC

Compliance

- Conductor resistance IEC 60228
- Insulation resistance IEC 60502-2
- Flammability test IEC 60332-1-2
- Partial Discharge test IEC 60502-2



Bending Radius:

Fixed Installation: 12D
D is overall diameter of cable



POLYCAB MV AL IEC 60502-2 12/20 KV
Medium Voltage Aluminium Armoured Cable, 12/20 (24) KV AC

DIMENSIONAL CHARACTERISTICS:

Product Code	No. of Cores	Core Cross sectional Area	Nominal Diameter			Weight (Approx.)
			Under armour	Over armour	Overall	
	No.	mm ²	mm	mm	mm	Kg/Km
MVIE19AXAWY2001C050SA001P	1	50	23.8	27.0	31.0	1150
MVIE19AXAWY2001C070SA001P	1	70	25.4	29.4	33.0	1350
MVIE19AXAWY2001C095SA001P	1	95	27.2	31.2	35.0	1500
MVIE19AXAWY2001C120SA001P	1	120	28.8	32.8	37.0	1650
MVIE19AXAWY2001C150SA001P	1	150	30.5	34.5	39.0	1850
MVIE19AXAWY2001C185SA001P	1	185	32.2	36.2	41.0	2050
MVIE19AXAWY2001C240SA001P	1	240	34.6	38.6	43.0	2350
MVIE19AXAWY2001C300SA001P	1	300	37.3	42.3	47.0	2800
MVIE19AXAWY2001C400SA001P	1	400	40.5	45.5	51.0	3250
MVIE19AXAWY2001C500SA001P	1	500	44.0	49.0	54.0	3800
MVIE19AXAWY2001C630SA001P	1	630	47.4	52.4	58.0	4400
MVIE19AXAWY2001C800SA001P	1	800	51.7	56.7	63.0	5150
MVIE19AXAWY2001C01KSA001P	1	1000	56.2	61.2	67.0	6000
MVIE19AXSWY2003C050SA001P	3	50	49.6	54.6	60.0	5400
MVIE19AXSWY2003C070SA001P	3	70	53.1	58.1	64.0	6000
MVIE19AXSWY2003C095SA001P	3	95	57.1	62.1	69.0	6750
MVIE19AXSWY2003C120SA001P	3	120	60.5	66.8	73.0	8200
MVIE19AXSWY2003C150SA001P	3	150	64.4	70.7	78.0	9050
MVIE19AXSWY2003C185SA001P	3	185	68.2	74.5	82.0	10000
MVIE19AXSWY2003C240SA001P	3	240	73.8	80.1	88.0	11250
MVIE19AXSWY2003C300SA001P	3	300	79.2	85.5	93.0	12650
MVIE19AXSWY2003C400SA001P	3	400	86.5	92.8	101.0	14500



POLYCAB MV AL IEC 60502-2 12/20 KV
Medium Voltage Aluminium Armoured Cable, 12/20 (24) KV AC

ELECTRICAL CHARACTERISTICS:

No. of Cores	Core Cross sectional Area mm ²	Max. DC Resistance at 20°C Ω/km	Max. AC Resistance at 90°C Ω/km	Approx. Capacitance μF/km	Approx. Inductance mH/km	Approx. Reactance Ω/km	Continuous Current Rating					
							In ground at 20°C		In Ducts		In air at 30°C	
							Flat	Trefoil	Flat	Trefoil	Flat	Trefoil
No.	mm ²	Ω/km	Ω/km	μF/km	mH/km	Ω/km	Amps					
1	50	0.641	0.822	0.17	0.44	0.14	157	152	146	142	189	184
1	70	0.443	0.568	0.19	0.42	0.13	192	186	178	176	236	230
1	95	0.320	0.410	0.21	0.40	0.13	229	221	213	210	287	280
1	120	0.253	0.325	0.23	0.38	0.12	260	252	242	240	332	324
1	150	0.206	0.264	0.25	0.37	0.12	288	281	271	267	376	368
1	185	0.164	0.211	0.27	0.36	0.11	324	317	307	303	432	424
1	240	0.125	0.161	0.30	0.34	0.11	373	367	356	351	511	502
1	300	0.100	0.129	0.33	0.34	0.11	419	414	402	397	586	577
1	400	0.0778	0.101	0.37	0.33	0.10	466	470	457	451	676	673
1	500	0.0605	0.080	0.44	0.26	0.08	525	530	510	505	760	750
1	630	0.0469	0.063	0.48	0.26	0.08	580	585	560	555	860	850
1	800	0.0367	0.051	0.53	0.25	0.08	650	655	620	615	960	950
1	1000	0.0291	0.042	0.59	0.24	0.07	715	705	670	665	1060	1050

No. of Cores	Core Cross sectional Area mm ²	Max. DC Resistance at 20°C Ω/km	Max. AC Resistance at 90°C Ω/km	Approx. Capacitance μF/km	Approx. Inductance mH/km	Approx. Reactance Ω/km	Continuous Current Rating		
							In ground at 20°C	In Ducts	In air at 30°C
							Amps		
3	50	0.641	0.822	0.17	0.37	0.12	140	122	158
3	70	0.443	0.568	0.19	0.35	0.11	171	150	196
3	95	0.320	0.410	0.21	0.34	0.11	203	179	236
3	120	0.253	0.325	0.23	0.32	0.10	232	205	273
3	150	0.206	0.264	0.25	0.31	0.10	260	231	309
3	185	0.164	0.211	0.27	0.30	0.10	294	262	355
3	240	0.125	0.161	0.30	0.29	0.09	340	305	415
3	300	0.100	0.129	0.33	0.28	0.09	384	346	475
3	400	0.0778	0.101	0.37	0.27	0.09	438	398	552

Maximum conductor temperature	90°C
Ambient air temperature	30°C
Ground temperature	20°C
Depth of laying	0.8 m
Thermal resistivity of soil	1.5 K.m/W
Thermal resistivity of earthenware ducts	1.2 K.m/W

Current rating de-rating factors for other than 30°C ambient air temperature.

Air Temperature	20	25	35	40	45	50	55	60
De-rating factor	1.08	1.04	0.96	0.91	0.87	0.82	0.76	0.71

Current rating de-rating factors for other than 20°C ground temperature.

Ground Temperature	10	15	25	30	35	40	45	50
De-rating factor	1.07	1.04	0.96	0.93	0.89	0.85	0.8	0.76



OUR CERTIFICATION
ISO 9001 | **ISO 14001** | **ISO 45001**



POLYCAB MV AL IEC 60502-2 18/30 KV
Medium Voltage Aluminium Armoured Cable, 18/30 (36) KV AC

Single Core



Three Core



- Outstanding Features**
- Flame retardant
 - High life
 - UV resistant
 - Oil resistant

Application

POLYCAB MV 18/30 KV XLPE insulated with Aluminium conductor single & multi core cable is suitable to use for power networks, underground, in cable ducting and also suitable for direct burial.

Voltage Rating

Nominal Voltage: 18/30 kV

Operation Temperature

Max. operating temperature: +90°C
 Max. Short Circuit Temperature: 250°C

Construction

- Conductor: Circular Compacted Aluminium conductor as per IEC 60228, class 2
- Conductor Screen: Extruded Semi-conductive compound
- Insulation: XLPE
- Non-Metallic Insulation Screen: Extruded Semi-conductive compound
- Metallic Insulation Screen: Copper tape screen
- Inner Sheath: Extruded Polyvinyl Chloride
- Armour:
 - Single Core: Aluminium Round Wire Armoured (AWA)
 - Multi Core: Galvanised Steel Round Wire (SWA)
- Outer Sheath: Extruded Polyvinyl Chloride, Colour: Black

Standard and References:

IEC 60228
 IEC 60502-2
 BS 6622

Test Voltage

63kV AC 50 Hz

Impulse Test Voltage

Peak 170kV AC

Compliance

- Conductor resistance IEC 60228
- Insulation resistance IEC 60502-2
- Flammability test IEC 60332-1-2
- Partial Discharge test IEC 60502-2



Bending Radius:

Fixed Installation: 12D
 D is overall diameter of cable



OUR CERTIFICATION
ISO 9001 | **ISO 14001** | **ISO 45001**



DIMENSIONAL CHARACTERISTICS:

Product Code	No. of Cores	Core Cross sectional Area	Nominal Diameter			Weight (Approx.)
			Under armour	Over armour	Overall	
	No.	mm ²	mm	mm	mm	Kg/Km
MVIE20AXAWY2001C050SA001P	1	50	28.8	32.8	37.0	1600
MVIE20AXAWY2001C070SA001P	1	70	30.4	34.4	39.0	1750
MVIE20AXAWY2001C095SA001P	1	95	32.2	36.2	41.0	1950
MVIE20AXAWY2001C120SA001P	1	120	33.8	37.8	42.0	2100
MVIE20AXAWY2001C150SA001P	1	150	35.7	40.7	46.0	2450
MVIE20AXAWY2001C185SA001P	1	185	37.4	42.4	47.0	2650
MVIE20AXAWY2001C240SA001P	1	240	39.8	44.8	50.0	3000
MVIE20AXAWY2001C300SA001P	1	300	42.5	47.5	53.0	3350
MVIE20AXAWY2001C400SA001P	1	400	45.7	50.7	56.0	3850
MVIE20AXAWY2001C500SA001P	1	500	49.2	54.2	60.0	4400
MVIE20AXAWY2001C630SA001P	1	630	52.6	57.6	63.0	5050
MVIE20AXAWY2001C800SA001P	1	800	56.9	61.9	68.0	5850
MVIE20AXAWY2001C01KSA001P	1	1000	61.4	66.4	73.0	6800
MVIE20AXSWY2003C050SA001P	3	50	60.8	67.1	74.0	8000
MVIE20AXSWY2003C070SA001P	3	70	64.3	70.6	78.0	8750
MVIE20AXSWY2003C095SA001P	3	95	68.3	74.6	82.0	9600
MVIE20AXSWY2003C120SA001P	3	120	71.9	78.2	86.0	10400
MVIE20AXSWY2003C150SA001P	3	150	75.6	81.9	90.0	11300
MVIE20AXSWY2003C185SA001P	3	185	79.4	85.7	94.0	12300
MVIE20AXSWY2003C240SA001P	3	240	85.0	91.3	100.0	13700
MVIE20AXSWY2003C300SA001P	3	300	90.6	96.9	106.0	15300
MVIE20AXSWY2003C400SA001P	3	400	97.7	104.0	113.0	17350

ELECTRICAL CHARACTERISTICS:

No. of Cores	Core Cross sectional Area	Max. DC Resistance at 20°C	Max. AC Resistance at 90°C	Approx. Capacitance	Approx. Inductance	Approx. Reactance	Continuous Current Rating					
							In ground at 20°C		In Ducts		In air at 30°C	
							Flat	Trefoil	Flat	Trefoil	Flat	Trefoil
No.	mm ²	Ω/km	Ω/km	μF/km	mH/km	Ω/km	Amps					
1	50	0.641	0.822	0.13	0.47	0.15	157	152	146	142	189	184
1	70	0.443	0.568	0.15	0.45	0.14	192	186	178	176	236	230
1	95	0.320	0.410	0.16	0.43	0.14	229	221	213	210	287	280
1	120	0.253	0.325	0.18	0.41	0.13	260	252	242	240	332	324
1	150	0.206	0.264	0.19	0.40	0.13	288	281	271	267	376	368
1	185	0.164	0.211	0.21	0.39	0.12	324	317	307	303	432	424
1	240	0.125	0.161	0.23	0.37	0.12	373	367	356	351	511	502
1	300	0.100	0.129	0.25	0.36	0.11	419	414	402	397	586	577
1	400	0.0778	0.101	0.28	0.35	0.11	466	470	457	451	676	673
1	500	0.0605	0.080	0.32	0.28	0.09	525	530	510	505	760	750
1	630	0.0469	0.063	0.35	0.27	0.09	580	585	560	555	860	850
1	800	0.0367	0.051	0.39	0.26	0.08	650	655	620	615	960	950
1	1000	0.0291	0.042	0.42	0.25	0.08	715	705	670	665	1060	1050

No. of Cores	Core Cross sectional Area	Max. DC Resistance at 20°C	Max. AC Resistance at 90°C	Approx. Capacitance	Approx. Inductance	Approx. Reactance	Continuous Current Rating		
							In ground at 20°C	In Ducts	In air at 30°C
							Amps		
No.	mm ²	Ω/km	Ω/km	μF/km	mH/km	Ω/km	Amps		
3	50	0.641	0.822	0.13	0.41	0.13	140	122	158
3	70	0.443	0.568	0.15	0.39	0.12	171	150	196
3	95	0.320	0.410	0.16	0.37	0.12	203	179	236
3	120	0.253	0.325	0.18	0.36	0.11	232	205	273
3	150	0.206	0.264	0.19	0.35	0.11	260	231	309
3	185	0.164	0.211	0.21	0.34	0.11	294	262	355
3	240	0.125	0.161	0.23	0.32	0.10	340	305	415
3	300	0.100	0.129	0.25	0.31	0.10	384	346	475
3	400	0.0778	0.101	0.28	0.30	0.09	438	398	552

Maximum conductor temperature 90°C
 Ambient air temperature 30°C
 Ground temperature 20°C
 Depth of laying 0.8 m
 Thermal resistivity of soil 1.5 K.m/W
 Thermal resistivity of earthenware ducts 1.2 K.m/W

Current rating de-rating factors for other than 30°C ambient air temperature.

Air Temperature	20	25	35	40	45	50	55	60
De-rating factor	1.08	1.04	0.96	0.91	0.87	0.82	0.76	0.71

Current rating de-rating factors for other than 20°C ground temperature.

Ground Temperature	10	15	25	30	35	40	45	50
De-rating factor	1.07	1.04	0.96	0.93	0.89	0.85	0.8	0.76



OUR CERTIFICATION
ISO 9001 | ISO 14001 | ISO 45001



OUR CERTIFICATION
ISO 9001 | ISO 14001 | ISO 45001



Polycab Medium Voltage High Tension Cable conforming to ICEA S-93-639 (NEMA WC-74)



Scan to watch
Polycab HT cable
manufacturing video



Polycab Medium Voltage High Tension Cables of voltage grade ranging from 5 kV to 36 kV are suitable for use in conduits, ducts, troughs, trays, and direct burial in wet and dry conditions, for power supply to wide networks. These cables are available with EPR insulation (XLPE insulation available on demand) having temperature rating of 105°C.

These cables are halogen free flame retardant in characteristic and provide continuous load and extra protection from short circuit and Fire.

Conductor: The high conductivity annealed plain stranded compacted aluminium/copper conductor is produced in-house with highly advanced machines.

Conductor Screen: It's an extruded layer of cross-linked semi-conducting compound that eliminates the risk of electric discharge at the interface between conductor and insulation. It also prevents electrical stress concentrations on the surface of the conductor.

Insulation: Developed in-house using Ethylene Propylene Rubber thermoset insulation compound (XLPE insulation available on demand).

Non-metallic Insulation Screen: An extruded layer of cross-linked semi-conducting compound, it forms the third protective layer after conductor screen and insulation. The screen eliminates micro voids and curing, thus extending the life of the cable.

Metallic Screen: A helically applied copper tape screen to carry fault current (corrugated/round wire copper screen is optional).

Laying Up: In case of 3 Core Cable, insulated cores are laid up together with fillers, developed in-house, to maintain circularity of cable and optional ground wire for earthing purpose.

Wrapping tape: In case of 3 core cable, a wrapping tape applied over laid up core assembly.

Optional Armour: It provides mechanical protection and also acts as return path for earth fault current.

Outer Sheath: Developed in-house, this thermoplastic compound emits less smoke and corrosive gases when exposed to fire.

The construction is based on the application and requirement of the user against ICEA S-93-639 / NEMA WC-74.



POLYTAB MV SC CU SCR ICEA S-93-639 5KV (or) 8KV



POLYTAB MV SC CU SCR ICEA S-93-639 15KV



POLYTAB MV SC CU SCR ICEA S-93-639 35KV



POLYTAB MV SC AL SCR ICEA S-93-639 8KV



POLYTAB MV SC AL SCR ICEA S-93-639 25KV



POLYTAB MV MC CU SCR ICEA S-93-639 5KV (or) 8KV



POLYTAB MV MC AL SCR ICEA S-93-639 15KV



POLYTAB MV MC CU SCR ICEA S-93-639 35KV



POLYTAB MV MC AL SCR ICEA S-93-639 8KV



POLYTAB MV MC AL SCR ICEA S-93-639 25KV



POLYTAB MV SC CU SCR ICEA S-93-639 8KV



POLYTAB MV SC CU SCR ICEA S-93-639 25KV



POLYTAB MV SC AL SCR ICEA S-93-639 5KV (or) 8KV



POLYTAB MV SC AL SCR ICEA S-93-639 15KV



POLYTAB MV SC AL SCR ICEA S-93-639 35KV



POLYTAB MV MC AL SCR ICEA S-93-639 8KV



POLYTAB MV MC AL SCR ICEA S-93-639 25KV



POLYTAB MV MC AL SCR ICEA S-93-639 5KV (or) 8KV



POLYTAB MV MC AL SCR ICEA S-93-639 15KV



POLYTAB MV MC AL SCR ICEA S-93-639 35KV

POLYCAB MV SC SCR ICEA S-93-639 5KV (or) 8 KV
MV Cable with Copper Conductor, EPR Insulation and Copper Screen

POLYCAB MV SC SCR ICEA S-93-639 5KV (or) 8 KV
MV Cable with Copper Conductor, EPR Insulation and Copper Screen

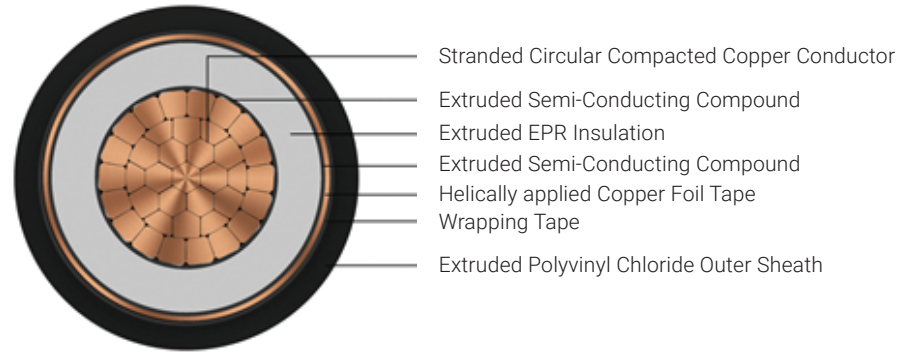

Outstanding Features

- Flame retardant
- High life
- Sunlight resistant
- Oil, Acid and Alkalies resistant
- Corona resistant
- Treeing resistant
- Moisture resistant

Application

POLYCAB MV 5 KV EPR insulated with Copper conductor single core cable is suitable to use in conduits, ducts, troughs, trays, direct burial in wet and dry conditions for power supply to wide networks.

Voltage Rating

Nominal Voltage: 5 kV AC (100% / 133%) or 8 kV AC (100%)

Operation Temperature

Operating temperature: -35°C to +105°C
Emergency operating temperature: 140°C
Max. Short Circuit Temperature: 250°C

Construction

- Conductor: Circular Compacted Copper conductor as per ASTM B496
- Conductor Screen: Extruded Semi-conductive compound
- Insulation: Extruded EPR (TR-XLPE will be provided on demand)
- Insulation Screen: Extruded Semi-conductive compound
- Metallic Insulation Screen: Helically applied copper tape (Round wire / Corrugated copper screen will be provided on demand)
- Outer Sheath: Extruded Polyvinyl Chloride, Colour: Black (Alternative Sheath: CPE Outer Sheath or LSZH Outer sheath, and parameters will change accordingly)

Bending Radius: 12D

D is overall diameter of cable

Standard and References:

- ASTM B496
- ICEA S-93-639 (NEMA WC-74)
- UL 1072
- UL 1685 / FT-1
- IEEE 1202
- UL 2556

Voltage Rating (kV AC)	High Voltage Test (kV AC)	Min. Partial discharge test (kV AC)	
		100% level	133% level
5	18	4	5
8	23	6	8

Compliance

- Conductor resistance ICEA S-93-639
- Insulation resistance ICEA S-93-639
- Vertical Tray Flame UL 1685
- Smoke Release UL 1685
- Flame Test IEEE 1202



DIMENSIONS, WEIGHT AND AMPACITY:

133% insulation (5kV) and 100% insulation (8kV):

Product Code	No. of Cores	Core Cross sectional Area	Nominal Diameter			Weight (Approx.) Kg/Km	Current rating *	
			Under metallic screen	Over metallic screen	Overall		Directly buried in ground	In air
	No.	AWG / MCM	mm	mm	mm	Amps		
MVIC36CRUAYF001C002AA001P	1	2 AWG	15.1	15.6	19.0	650	140	210
MVIC36CRUAYF001C001AA001P	1	1 AWG	15.9	16.4	19.5	750	160	240
MVIC36CRUAYF001C1X0AA001P	1	1/0 AWG	16.9	17.4	20.5	900	185	285
MVIC36CRUAYF001C2X0AA001P	1	2/0 AWG	17.9	18.4	21.5	1050	215	330
MVIC36CRUAYF001C3X0AA001P	1	3/0 AWG	19.1	19.6	23.5	1300	245	385
MVIC36CRUAYF001C4X0AA001P	1	4/0 AWG	20.4	20.9	25.0	1500	285	445
MVIC36CRUAYF001C250CA001P	1	250 MCM	21.7	22.2	26.5	1750	315	500
MVIC36CRUAYF001C350CA001P	1	350 MCM	24.1	24.6	28.5	2250	385	625
MVIC36CRUAYF001C500CA001P	1	500 MCM	27.2	27.7	31.5	3000	470	765
MVIC36CRUAYF001C600CA001P	1	600 MCM	29.7	30.2	34.5	3600	520	855
MVIC36CRUAYF001C750CA001P	1	750 MCM	32.1	32.7	36.5	4350	585	970
MVIC36CRUAYF001C01KCA001P	1	1000 MCM	35.7	36.2	40.0	5550	675	1155

100% insulation (5kV):

Product Code	No. of Cores	Core Cross sectional Area	Nominal Diameter			Weight (Approx.) Kg/Km	Current rating *	
			Under metallic screen	Over metallic screen	Overall		Directly buried in ground	In air
	No.	AWG / MCM	mm	mm	mm	Amps		
MVIC36CRUAYF001C002AA002P	1	2 AWG	13.8	14.3	17.5	600	140	210
MVIC36CRUAYF001C001AA002P	1	1 AWG	14.7	15.2	18.5	700	160	240
MVIC36CRUAYF001C1X0AA002P	1	1/0 AWG	15.6	16.1	19.5	850	185	285
MVIC36CRUAYF001C2X0AA002P	1	2/0 AWG	16.6	17.2	20.5	1000	215	330
MVIC36CRUAYF001C3X0AA002P	1	3/0 AWG	17.8	18.3	21.5	1200	245	385
MVIC36CRUAYF001C4X0AA002P	1	4/0 AWG	19.2	19.7	23.5	1450	285	445
MVIC36CRUAYF001C250CA002P	1	250 MCM	20.4	20.9	25.0	1650	315	500
MVIC36CRUAYF001C350CA002P	1	350 MCM	22.9	23.4	27.5	2200	385	625
MVIC36CRUAYF001C500CA002P	1	500 MCM	25.9	26.4	30.5	2950	470	765
MVIC36CRUAYF001C600CA002P	1	600 MCM	27.9	28.4	32.5	3450	520	855
MVIC36CRUAYF001C750CA002P	1	750 MCM	30.3	30.8	35.0	4200	585	970
MVIC36CRUAYF001C01KCA002P	1	1000 MCM	33.8	34.3	38.5	5400	675	1155

* Current Rating based on Table 310.16 (20°C Ambient Ground Temperature) and Table 310.17 (30°C Ambient Air Temperature) of National Electric Code



POLYCAB MV SC SCR ICEA S-93-639 5KV (or) 8 KV
MV Cable with Copper Conductor, EPR Insulation and Copper Screen

ELECTRICAL CHARACTERISTICS:

133% insulation:

No. of Cores	Core Cross sectional Area	Nom. DC Resistance at 25°C	Nom. AC Resistance at 90°C	Approx. Capacitance	Approx. Inductance	Approx. Reactance	Max. pulling tension on conductor	Charging Current per phase	Positive sequence impedance	Electric Stress at Conductor Screen	Short circuit rating	
No.	AWG / MCM	Ω/km	Ω/km	μF/km	mH/km	Ω/km	kN	Amps/Km	Ohms/Km	kV/mm	Phase conductor	Metallic screen
											kA/S	
1	2 AWG	0.531	0.666	0.30	0.41	0.15	2.4	0.56	0.68	2.1	4.8	2.0
1	1 AWG	0.423	0.528	0.32	0.39	0.15	3.0	0.60	0.55	2.1	6.1	2.1
1	1/0 AWG	0.335	0.420	0.35	0.38	0.14	3.7	0.66	0.44	2.0	7.7	2.2
1	2/0 AWG	0.266	0.331	0.38	0.36	0.13	4.7	0.71	0.36	1.9	9.7	2.3
1	3/0 AWG	0.211	0.266	0.41	0.35	0.13	6.0	0.78	0.30	1.9	12.2	2.5
1	4/0 AWG	0.167	0.210	0.45	0.34	0.13	7.5	0.85	0.25	1.9	15.3	2.6
1	250 MCM	0.141	0.177	0.49	0.33	0.13	8.9	0.92	0.22	1.8	18.1	2.8
1	350 MCM	0.101	0.128	0.56	0.31	0.12	12.4	1.05	0.17	1.7	25.4	3.1
1	500 MCM	0.071	0.092	0.64	0.30	0.11	17.7	1.21	0.15	1.7	36.2	3.5
1	600 MCM	0.059	0.076	0.72	0.30	0.11	21.3	1.35	0.13	1.5	43.5	3.8
1	750 MCM	0.047	0.066	0.79	0.29	0.11	26.6	1.48	0.13	1.5	54.4	4.1
1	1000 MCM	0.035	0.052	0.89	0.27	0.10	35.4	1.67	0.12	1.5	72.5	4.5

100% insulation:

No. of Cores	Core Cross sectional Area	Nom. DC Resistance at 25°C	Nom. AC Resistance at 90°C	Approx. Capacitance	Approx. Inductance	Approx. Reactance	Max. pulling tension on conductor	Charging Current per phase	Positive sequence impedance	Electric Stress at Conductor Screen	Short circuit rating	
No.	AWG / MCM	Ω/km	Ω/km	μF/km	mH/km	Ω/km	kN	Amps/Km	Ohms/Km	kV/mm	Phase conductor	Metallic screen
											kA/S	
1	2 AWG	0.531	0.666	0.36	0.39	0.15	2.4	0.68	1.11	2.5	4.8	1.8
1	1 AWG	0.423	0.528	0.39	0.38	0.14	3.0	0.73	0.88	2.4	6.1	1.9
1	1/0 AWG	0.335	0.420	0.42	0.37	0.14	3.7	0.80	0.71	2.4	7.7	2.0
1	2/0 AWG	0.266	0.331	0.46	0.35	0.13	4.7	0.87	0.56	2.3	9.7	2.2
1	3/0 AWG	0.211	0.266	0.51	0.33	0.13	6.0	0.95	0.45	2.2	12.2	2.3
1	4/0 AWG	0.167	0.210	0.56	0.33	0.12	7.5	1.05	0.37	2.2	15.3	2.5
1	250 MCM	0.141	0.177	0.60	0.32	0.12	8.9	1.14	0.32	2.1	18.1	2.6
1	350 MCM	0.101	0.128	0.69	0.30	0.11	12.4	1.30	0.24	2.0	25.4	2.9
1	500 MCM	0.071	0.092	0.80	0.29	0.11	17.7	1.51	0.18	2.0	36.2	3.3
1	600 MCM	0.059	0.076	0.88	0.28	0.11	21.3	1.65	0.16	1.9	43.5	3.6
1	750 MCM	0.047	0.066	0.96	0.28	0.10	26.6	1.82	0.14	1.9	54.4	3.9
1	1000 MCM	0.035	0.052	1.09	0.27	0.10	35.4	2.06	0.13	1.9	72.5	4.3

POLYCAB MV SC SCR UAR ICEA S-93-639 8KV
MV Cable with Copper Conductor, EPR Insulation and Copper Screen

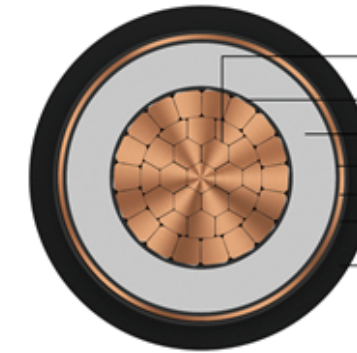

- Stranded Circular Compacted Copper Conductor
- Extruded Semi-Conducting Compound
- Extruded EPR Insulation
- Extruded Semi-Conducting Compound
- Helically applied Copper Tape
- Wrapping Tape
- Extruded Polyvinyl Chloride Outer Sheath

Outstanding Features

- Flame retardant
- High life
- Sunlight resistant
- Oil, Acid and Alkalies resistant
- Corona resistant
- Treeing resistant
- Moisture resistant

Application

POLYCAB MV 8KV EPR insulated with Copper conductor single core cable is suitable to use in conduits, ducts, troughs, trays, direct burial in wet and dry conditions for power supply to wide networks.

Voltage Rating

Nominal Voltage: 8kV AC

Operation Temperature

Operating temperature: -35°C to +105°C
 Emergency operating temperature: 140°C
 Max. Short Circuit Temperature: 250°C

Construction

- Conductor: Circular Compacted Copper conductor as per ASTM B496
- Conductor Screen: Extruded Semi-conductive compound
- Insulation: Extruded EPR (TR-XLPE will be provided on demand)
- Insulation Screen: Extruded Semi-conductive compound
- Metallic Insulation Screen: Helically applied copper tape (Round wire / Corrugated copper screen will be provided on demand)
- Outer Sheath: Extruded Polyvinyl Chloride, Colour: Black (Alternative Sheath: CPE Outer Sheath or LSZH Outer sheath, and parameters will change accordingly)

Standard and References:

- ASTM B496
- ICEA S-93-639 (NEMA WC-74)
- UL 1072
- UL 1685 / FT-1
- IEEE 1202
- UL 2556

Voltage Rating (kV AC)	High Voltage Test (kV AC)		Min. Partial discharge test (kV AC)	
	100% level	133% level	100% level	133% level
8	23	28	6	8

Compliance

- Conductor resistance ICEA S-93-639
- Insulation resistance ICEA S-93-639
- Vertical Tray Flame UL 1685
- Smoke Release UL 1685
- Flame Test IEEE 1202

Bending Radius: 12D

D is overall diameter of cable



OUR CERTIFICATION
 ISO 9001 | ISO 14001 | ISO 45001



OUR CERTIFICATION
 ISO 9001 | ISO 14001 | ISO 45001



DIMENSIONS, WEIGHT AND AMPACITY:

133% insulation:

Product Code	No. of Cores	Core Cross sectional Area	Nominal Diameter			Weight (Approx.) Kg/Km	Current rating *	
			Under metallic screen	Over metallic screen	Overall		Directly buried in ground	In air
	No.	AWG / MCM	mm	mm	mm	Amps		
MVIC48CRUAYF001C002AA001P	1	2 AWG	16.4	16.9	20.0	700	140	210
MVIC48CRUAYF001C001AA001P	1	1 AWG	17.2	17.7	21.0	800	160	240
MVIC48CRUAYF001C1X0AA001P	1	1/0 AWG	18.1	18.6	22.5	1000	185	285
MVIC48CRUAYF001C2X0AA001P	1	2/0 AWG	19.2	19.7	24.0	1150	215	330
MVIC48CRUAYF001C3X0AA001P	1	3/0 AWG	20.4	20.9	25.0	1350	245	385
MVIC48CRUAYF001C4X0AA001P	1	4/0 AWG	21.7	22.2	26.5	1550	285	445
MVIC48CRUAYF001C250CA001P	1	250 MCM	23.0	23.5	27.5	1800	315	500
MVIC48CRUAYF001C350CA001P	1	350 MCM	25.4	25.9	30.0	2300	385	625
MVIC48CRUAYF001C500CA001P	1	500 MCM	28.4	28.9	33.0	3100	470	765
MVIC48CRUAYF001C600CA001P	1	600 MCM	30.5	31.0	35.0	3600	520	855
MVIC48CRUAYF001C750CA001P	1	750 MCM	32.9	33.4	37.5	4350	585	970
MVIC48CRUAYF001C01KCA001P	1	1000 MCM	36.4	36.9	41.0	5600	675	1155

100% insulation (5kV):

Product Code	No. of Cores	Core Cross sectional Area	Nominal Diameter			Weight (Approx.) Kg/Km	Current rating *	
			Under metallic screen	Over metallic screen	Overall		Directly buried in ground	In air
	No.	AWG / MCM	mm	mm	mm	Amps		
MVIC48CRUAYF001C002AA002P	1	2 AWG	15.1	15.6	19.0	650	140	210
MVIC48CRUAYF001C001AA002P	1	1 AWG	15.9	16.4	19.5	750	160	240
MVIC48CRUAYF001C1X0AA002P	1	1/0 AWG	16.9	17.4	20.5	900	185	285
MVIC48CRUAYF001C2X0AA002P	1	2/0 AWG	17.9	18.4	21.5	1050	215	330
MVIC48CRUAYF001C3X0AA002P	1	3/0 AWG	19.1	19.6	23.5	1300	245	385
MVIC48CRUAYF001C4X0AA002P	1	4/0 AWG	20.4	20.9	25.0	1500	285	445
MVIC48CRUAYF001C250CA002P	1	250 MCM	21.7	22.2	26.5	1750	315	500
MVIC48CRUAYF001C350CA002P	1	350 MCM	24.1	24.6	28.5	2250	385	625
MVIC48CRUAYF001C500CA002P	1	500 MCM	27.2	27.7	31.5	3000	470	765
MVIC48CRUAYF001C600CA002P	1	600 MCM	29.7	30.2	34.5	3600	520	855
MVIC48CRUAYF001C750CA002P	1	750 MCM	32.1	32.7	36.5	4350	585	970
MVIC48CRUAYF001C01KCA002P	1	1000 MCM	35.7	36.2	40.0	5550	675	1155

* Current Rating based on Table 310.16 (20°C Ambient Ground Temperature) and Table 310.17 (30°C Ambient Air Temperature) of National Electric Code

ELECTRICAL CHARACTERISTICS:

133% insulation:

No. of Cores	Core Cross sectional Area	Nom. DC Resistance at 25°C	Nom. AC Resistance at 90°C	Approx. Capacitance	Approx. Inductance	Approx. Reactance	Max. pulling tension on conductor	Charging Current per phase	Positive sequence impedance	Electric Stress at Conductor Screen	Short circuit rating	
											Phase conductor	Metallic screen
No.	AWG / MCM	Ω/km	Ω/km	μF/km	mH/km	Ω/km	kN	Amps/Km	Ohms/Km	kV/mm	kA/S	
1	2 AWG	0.531	0.666	0.26	0.42	0.16	2.4	0.77	0.69	3.0	4.8	2.1
1	1 AWG	0.423	0.528	0.28	0.41	0.15	3.0	0.83	0.55	2.9	6.1	2.2
1	1/0 AWG	0.335	0.420	0.30	0.40	0.15	3.7	0.90	0.45	2.8	7.7	2.3
1	2/0 AWG	0.266	0.331	0.32	0.38	0.14	4.7	0.98	0.36	2.7	9.7	2.5
1	3/0 AWG	0.211	0.266	0.35	0.36	0.14	6.0	1.06	0.30	2.7	12.2	2.6
1	4/0 AWG	0.167	0.210	0.38	0.35	0.13	7.5	1.16	0.25	2.6	15.3	2.8
1	250 MCM	0.141	0.177	0.41	0.34	0.13	8.9	1.25	0.22	2.5	18.1	3.0
1	350 MCM	0.101	0.128	0.47	0.32	0.12	12.4	1.42	0.18	2.4	25.4	3.3
1	500 MCM	0.071	0.092	0.54	0.31	0.12	17.7	1.64	0.15	2.3	36.2	3.6
1	600 MCM	0.059	0.076	0.59	0.30	0.11	21.3	1.78	0.14	2.2	43.5	3.9
1	750 MCM	0.047	0.066	0.65	0.29	0.11	26.6	1.95	0.13	2.2	54.4	4.2
1	1000 MCM	0.035	0.052	0.73	0.28	0.11	35.4	2.20	0.12	2.2	72.5	4.6

100% insulation:

No. of Cores	Core Cross sectional Area	Nom. DC Resistance at 25°C	Nom. AC Resistance at 90°C	Approx. Capacitance	Approx. Inductance	Approx. Reactance	Max. pulling tension on conductor	Charging Current per phase	Positive sequence impedance	Electric Stress at Conductor Screen	Short circuit rating	
											Phase conductor	Metallic screen
No.	AWG / MCM	Ω/km	Ω/km	μF/km	mH/km	Ω/km	kN	Amps/Km	Ohms/Km	kV/mm	kA/S	
1	2 AWG	0.531	0.666	0.30	0.41	0.15	2.4	0.56	0.68	2.1	4.8	2.0
1	1 AWG	0.423	0.528	0.32	0.39	0.15	3.0	0.60	0.55	2.1	6.1	2.1
1	1/0 AWG	0.335	0.420	0.35	0.38	0.14	3.7	0.66	0.44	2.0	7.7	2.2
1	2/0 AWG	0.266	0.331	0.38	0.36	0.13	4.7	0.71	0.36	1.9	9.7	2.3
1	3/0 AWG	0.211	0.266	0.41	0.35	0.13	6.0	0.78	0.30	1.9	12.2	2.5
1	4/0 AWG	0.167	0.210	0.45	0.34	0.13	7.5	0.85	0.25	1.9	15.3	2.6
1	250 MCM	0.141	0.177	0.49	0.33	0.13	8.9	0.92	0.22	1.8	18.1	2.8
1	350 MCM	0.101	0.128	0.56	0.31	0.12	12.4	1.05	0.17	1.7	25.4	3.1
1	500 MCM	0.071	0.092	0.64	0.30	0.11	17.7	1.21	0.15	1.7	36.2	3.5
1	600 MCM	0.059	0.076	0.72	0.30	0.11	21.3	1.35	0.13	1.5	43.5	3.8
1	750 MCM	0.047	0.066	0.79	0.29	0.11	26.6	1.48	0.13	1.5	54.4	4.1
1	1000 MCM	0.035	0.052	0.89	0.27	0.10	35.4	1.67	0.12	1.5	72.5	4.5



OUR CERTIFICATION
ISO 9001 | ISO 14001 | ISO 45001



OUR CERTIFICATION
ISO 9001 | ISO 14001 | ISO 45001



POLYCAB MV SC SCR ICEA S-93-639 15KV
MV Cable with Copper Conductor, EPR Insulation and Copper Screen

POLYCAB MV SC SCR ICEA S-93-639 15KV
MV Cable with Copper Conductor, EPR Insulation and Copper Screen

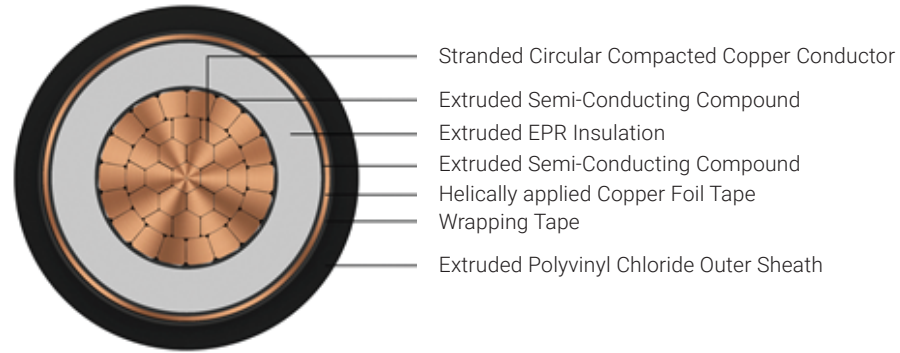

Outstanding Features

- Flame retardant
- High life
- Sunlight resistant
- Oil, Acid and Alkalies resistant
- Corona resistant
- Treeing resistant
- Moisture resistant

Application

POLYCAB MV 15KV EPR insulated with Copper conductor single core cable is suitable to use in conduits, ducts, troughs, trays, direct burial in wet and dry conditions for power supply to wide networks.

Voltage Rating

Nominal Voltage: 15kV AC

Operation Temperature

Operating temperature: -35°C to +105°C
Emergency operating temperature: 140°C
Max. Short Circuit Temperature: 250°C

Construction

- Conductor: Circular Compacted Copper conductor as per ASTM B496
- Conductor Screen: Extruded Semi-conductive compound
- Insulation: Extruded EPR (TR-XLPE will be provided on demand)
- Insulation Screen: Extruded Semi-conductive compound
- Metallic Insulation Screen: Helically applied copper tape (Round wire / Corrugated copper screen will be provided on demand)
- Outer Sheath: Extruded Polyvinyl Chloride, Colour: Black (Alternative Sheath: CPE Outer Sheath or LSZH Outer sheath, and parameters will change accordingly)

Bending Radius: 12D

D is overall diameter of cable

Standard and References:

- ASTM B496
- ICEA S-93-639 (NEMA WC-74)
- UL 1072
- UL 1685 / FT-1
- IEEE 1202
- UL 2556

Voltage Rating (kV AC)	High Voltage Test (kV AC)		Min. Partial discharge test (kV AC)	
	100% level	133% level	100% level	133% level
8	23	28	6	8

Compliance

- Conductor resistance ICEA S-93-639
- Insulation resistance ICEA S-93-639
- Vertical Tray Flame UL 1685
- Smoke Release UL 1685
- Flame Test IEEE 1202



DIMENSIONS, WEIGHT AND AMPACITY:

133% insulation:

Product Code	No. of Cores	Core Cross sectional Area	Nominal Diameter			Weight (Approx.) Kg/Km	Current rating *	
			Under metallic screen	Over metallic screen	Overall		Directly buried in ground	In air
	No.	AWG / MCM	mm	mm	mm	Amps		
MVIC37CRUAYF001C002AA001P	1	2 AWG	20.4	20.9	25.0	950	140	210
MVIC37CRUAYF001C001AA001P	1	1 AWG	21.3	21.8	26.0	1050	160	240
MVIC37CRUAYF001C1X0AA001P	1	1/0 AWG	22.2	22.7	27.0	1200	185	285
MVIC37CRUAYF001C2X0AA001P	1	2/0 AWG	23.3	23.8	28.0	1350	215	330
MVIC37CRUAYF001C3X0AA001P	1	3/0 AWG	24.4	24.9	29.0	1550	245	385
MVIC37CRUAYF001C4X0AA001P	1	4/0 AWG	25.8	26.3	30.5	1800	285	445
MVIC37CRUAYF001C250CA001P	1	250 MCM	27.0	27.6	31.5	2050	315	500
MVIC37CRUAYF001C350CA001P	1	350 MCM	29.5	30.0	34.0	2600	385	625
MVIC37CRUAYF001C500CA001P	1	500 MCM	32.5	33.0	37.0	3350	470	765
MVIC37CRUAYF001C600CA001P	1	600 MCM	35.1	35.6	39.5	3950	520	855
MVIC37CRUAYF001C750CA001P	1	750 MCM	37.5	38.0	42.0	4750	585	970
MVIC37CRUAYF001C01KCA001P	1	1000 MCM	41.0	41.5	47.0	6150	675	1155

100% insulation:

Product Code	No. of Cores	Core Cross sectional Area	Nominal Diameter			Weight (Approx.) Kg/Km	Current rating *	
			Under metallic screen	Over metallic screen	Overall		Directly buried in ground	In air
	No.	AWG / MCM	mm	mm	mm	Amps		
MVIC37CRUAYF001C002AA002P	1	2 AWG	18.1	18.7	22.0	800	140	210
MVIC37CRUAYF001C001AA002P	1	1 AWG	19.0	19.5	23.5	950	160	240
MVIC37CRUAYF001C1X0AA002P	1	1/0 AWG	19.9	20.4	24.5	1050	185	285
MVIC37CRUAYF001C2X0AA002P	1	2/0 AWG	21.0	21.5	25.5	1250	215	330
MVIC37CRUAYF001C3X0AA002P	1	3/0 AWG	22.2	22.7	26.5	1450	245	385
MVIC37CRUAYF001C4X0AA002P	1	4/0 AWG	23.5	24.0	28.0	1650	285	445
MVIC37CRUAYF001C250CA002P	1	250 MCM	24.8	25.3	29.5	1900	315	500
MVIC37CRUAYF001C350CA002P	1	350 MCM	27.2	27.7	31.5	2450	385	625
MVIC37CRUAYF001C500CA002P	1	500 MCM	30.2	30.7	35.0	3200	470	765
MVIC37CRUAYF001C600CA002P	1	600 MCM	32.2	32.7	37.0	3750	520	855
MVIC37CRUAYF001C750CA002P	1	750 MCM	34.6	35.1	39.0	4500	585	970
MVIC37CRUAYF001C01KCA002P	1	1000 MCM	38.2	38.7	44.5	5900	675	1155

* Current Rating based on Table 310.16 (20°C Ambient Ground Temperature) and Table 310.17 (30°C Ambient Air Temperature) of National Electric Code



POLYCAB MV SC SCR ICEA S-93-639 15KV
MV Cable with Copper Conductor, EPR Insulation and Copper Screen

ELECTRICAL CHARACTERISTICS:

133% insulation:

No. of Cores	Core Cross sectional Area	Nom. DC Resistance at 25°C	Nom. AC Resistance at 90°C	Approx. Capacitance	Approx. Inductance	Approx. Reactance	Max. pulling tension on conductor	Charging Current per phase	Positive sequence impedance	Electric Stress at Conductor Screen	Short circuit rating	
No.	AWG / MCM	Ω/km	Ω/km	μF/km	mH/km	Ω/km	kN	Amps/Km	Ohms/Km	kV/mm	Phase conductor	Metallic screen
											kA/S	
1	2 AWG	0.531	0.666	0.19	0.46	0.18	2.4	1.05	0.69	1.61	4.3	4.8
1	1 AWG	0.423	0.528	0.20	0.45	0.17	3.0	1.13	0.56	1.43	4.1	6.1
1	1/0 AWG	0.335	0.420	0.21	0.43	0.16	3.7	1.21	0.45	1.29	4.0	7.7
1	2/0 AWG	0.266	0.331	0.23	0.41	0.15	4.7	1.30	0.37	1.16	3.8	9.7
1	3/0 AWG	0.211	0.266	0.25	0.39	0.15	6.0	1.41	0.30	1.06	3.7	12.2
1	4/0 AWG	0.167	0.210	0.27	0.38	0.14	7.5	1.52	0.25	0.96	3.6	15.3
1	250 MCM	0.141	0.177	0.29	0.37	0.14	8.9	1.64	0.23	0.89	3.4	18.1
1	350 MCM	0.101	0.128	0.33	0.35	0.13	12.4	1.84	0.18	0.79	3.3	25.4
1	500 MCM	0.071	0.092	0.37	0.33	0.12	17.7	2.11	0.15	0.69	3.2	36.2
1	600 MCM	0.059	0.076	0.41	0.32	0.12	21.3	2.33	0.14	0.56	3.0	43.5
1	750 MCM	0.047	0.066	0.45	0.31	0.12	26.6	2.53	0.14	0.59	2.9	54.4
1	1000 MCM	0.035	0.052	0.50	0.31	0.12	35.4	2.83	0.13	0.53	2.8	72.5

100% insulation:

No. of Cores	Core Cross sectional Area	Nom. DC Resistance at 25°C	Nom. AC Resistance at 90°C	Approx. Capacitance	Approx. Inductance	Approx. Reactance	Max. pulling tension on conductor	Charging Current per phase	Positive sequence impedance	Electric Stress at Conductor Screen	Short circuit rating	
No.	AWG / MCM	Ω/km	Ω/km	μF/km	mH/km	Ω/km	kN	Amps/Km	Ohms/Km	kV/mm	Phase conductor	Metallic screen
											kA/S	
1	2 AWG	0.531	0.666	0.22	0.44	0.17	2.4	1.23	0.69	1.72	4.9	4.8
1	1 AWG	0.423	0.528	0.23	0.43	0.16	3.0	1.32	0.56	1.54	4.8	6.1
1	1/0 AWG	0.335	0.420	0.25	0.41	0.16	3.7	1.43	0.45	1.38	4.6	7.7
1	2/0 AWG	0.266	0.331	0.27	0.39	0.15	4.7	1.54	0.36	1.25	4.4	9.7
1	3/0 AWG	0.211	0.266	0.30	0.38	0.14	6.0	1.67	0.30	1.14	4.3	12.2
1	4/0 AWG	0.167	0.210	0.32	0.36	0.14	7.5	1.81	0.25	1.03	4.2	15.3
1	250 MCM	0.141	0.177	0.35	0.35	0.13	8.9	1.95	0.22	0.96	4.0	18.1
1	350 MCM	0.101	0.128	0.39	0.33	0.13	12.4	2.22	0.18	0.84	3.9	25.4
1	500 MCM	0.071	0.092	0.45	0.32	0.12	17.7	2.54	0.15	0.73	3.7	36.2
1	600 MCM	0.059	0.076	0.49	0.31	0.12	21.3	2.76	0.14	0.60	3.6	43.5
1	750 MCM	0.047	0.066	0.53	0.30	0.11	26.6	3.01	0.13	0.63	3.5	54.4
1	1000 MCM	0.035	0.052	0.60	0.29	0.11	35.4	3.39	0.12	0.56	3.5	72.5

POLYCAB MV SC SCR ICEA S-93-639 25KV
MV Cable with Copper Conductor, EPR Insulation and Copper Screen

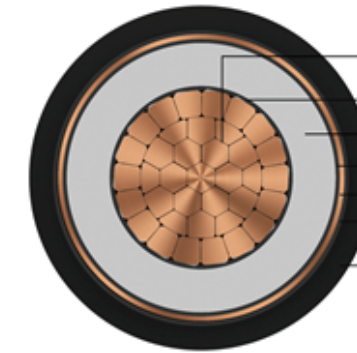

- Stranded Circular Compacted Copper Conductor
- Extruded Semi-Conducting Compound
- Extruded EPR Insulation
- Extruded Semi-Conducting Compound
- Helically applied Copper Tape
- Wrapping Tape
- Extruded Polyvinyl Chloride Outer Sheath

Outstanding Features

- Flame retardant
- High life
- Sunlight resistant
- Oil, Acid and Alkalies resistant
- Corona resistant
- Treeing resistant
- Moisture resistant

Application

POLYCAB MV 25KV EPR insulated with Copper conductor single core cable is suitable to use in conduits, ducts, troughs, trays, direct burial in wet and dry conditions for power supply to wide networks.

Voltage Rating

Nominal Voltage: 25kV AC

Operation Temperature

Operating temperature: -35°C to +105°C
 Emergency operating temperature: 140°C
 Max. Short Circuit Temperature: 250°C

Construction

- Conductor: Circular Compacted Copper conductor as per ASTM B496
- Conductor Screen: Extruded Semi-conductive compound
- Insulation: Extruded EPR (TR-XLPE will be provided on demand)
- Insulation Screen: Extruded Semi-conductive compound
- Metallic Insulation Screen: Helically applied copper tape (*Round wire / Corrugated copper screen will be provided on demand*)
- Outer Sheath: Extruded Polyvinyl Chloride, Colour: Black (*Alternative Sheath: CPE Outer Sheath or LSZH Outer sheath, and parameters will change accordingly*)

Bending Radius: 12D

D is overall diameter of cable

Standard and References:

- ASTM B496
- ICEA S-93-639 (NEMA WC-74)
- UL 1072
- UL 1685 / FT-1
- IEEE 1202
- UL 2556

Voltage Rating (kV AC)	High Voltage Test (kV AC)	
	100% level	133% level
25	52	64

Compliance

- Conductor resistance ICEA S-93-639
- Insulation resistance ICEA S-93-639
- Vertical Tray Flame UL 1685
- Smoke Release UL 1685
- Flame Test IEEE 1202



OUR CERTIFICATION
 ISO 9001 | ISO 14001 | ISO 45001



OUR CERTIFICATION
 ISO 9001 | ISO 14001 | ISO 45001



DIMENSIONS, WEIGHT AND AMPACITY:

133% insulation:

Product Code	No. of Cores	Core Cross sectional Area	Nominal Diameter			Weight (Approx.) Kg/Km	Current rating *	
			Under metallic screen	Over metallic screen	Overall		Directly buried in ground	In air
	No.	AWG / MCM	mm	mm	mm	Amps		
MVIC32CRUAYF001C002AA001P	1	2 AWG	25.5	26.0	30.0	1250	140	210
MVIC32CRUAYF001C001AA001P	1	1 AWG	26.3	26.9	31.0	1350	160	240
MVIC32CRUAYF001C1X0AA001P	1	1/0 AWG	27.3	27.8	32.0	1500	185	285
MVIC32CRUAYF001C2X0AA001P	1	2/0 AWG	28.3	28.8	33.0	1650	215	330
MVIC32CRUAYF001C3X0AA001P	1	3/0 AWG	29.5	30.0	34.0	1900	245	385
MVIC32CRUAYF001C4X0AA001P	1	4/0 AWG	30.8	31.3	35.5	2150	285	445
MVIC32CRUAYF001C250CA001P	1	250 MCM	32.1	32.6	36.5	2400	315	500
MVIC32CRUAYF001C350CA001P	1	350 MCM	34.5	35.1	39.0	2950	385	625
MVIC32CRUAYF001C500CA001P	1	500 MCM	37.6	38.1	42.0	3800	470	765
MVIC32CRUAYF001C600CA001P	1	600 MCM	40.2	40.7	44.5	4400	520	855
MVIC32CRUAYF001C750CA001P	1	750 MCM	42.6	43.1	47.0	5200	585	970
MVIC32CRUAYF001C01KCA001P	1	1000 MCM	46.1	46.6	52.0	6650	675	1155

100% insulation (5kV):

Product Code	No. of Cores	Core Cross sectional Area	Nominal Diameter			Weight (Approx.) Kg/Km	Current rating *	
			Under metallic screen	Over metallic screen	Overall		Directly buried in ground	In air
	No.	AWG / MCM	mm	mm	mm	Amps		
MVIC32CRUAYF001C002AA002P	1	2 AWG	22.5	23.0	27.0	1050	140	210
MVIC32CRUAYF001C001AA002P	1	1 AWG	23.3	23.8	28.0	1150	160	240
MVIC32CRUAYF001C1X0AA002P	1	1/0 AWG	24.2	24.7	29.0	1300	185	285
MVIC32CRUAYF001C2X0AA002P	1	2/0 AWG	25.3	25.8	30.0	1500	215	330
MVIC32CRUAYF001C3X0AA002P	1	3/0 AWG	26.5	27.0	31.0	1700	245	385
MVIC32CRUAYF001C4X0AA002P	1	4/0 AWG	27.8	28.3	32.5	1950	285	445
MVIC32CRUAYF001C250CA002P	1	250 MCM	29.1	29.6	33.5	2150	315	500
MVIC32CRUAYF001C350CA002P	1	350 MCM	31.5	32.0	36.0	2750	385	625
MVIC32CRUAYF001C500CA002P	1	500 MCM	34.5	35.0	39.0	3550	470	765
MVIC32CRUAYF001C600CA002P	1	600 MCM	36.5	37.1	42.5	4250	520	855
MVIC32CRUAYF001C750CA002P	1	750 MCM	39.0	39.5	45.0	5000	585	970
MVIC32CRUAYF001C01KCA002P	1	1000 MCM	42.5	43.0	48.5	6300	675	1155

* Current Rating based on Table 310.16 (20°C Ambient Ground Temperature) and Table 310.17 (30°C Ambient Air Temperature) of National Electric Code

ELECTRICAL CHARACTERISTICS:

133% insulation:

No. of Cores	Core Cross sectional Area	Nom. DC Resistance at 25°C	Nom. AC Resistance at 90°C	Approx. Capacitance	Approx. Inductance	Approx. Reactance	Max. pulling tension on conductor	Charging Current per phase	Positive sequence impedance	Electric Stress at Conductor Screen	Short circuit rating	
											Phase conductor	Metallic screen
No.	AWG / MCM	Ω/km	Ω/km	μF/km	mH/km	Ω/km	kN	Amps/Km	Ohms/Km	kV/mm	kA/S	
1	2 AWG	0.531	0.666	0.15	0.50	0.19	2.4	1.39	0.69	5.8	4.8	3.3
1	1 AWG	0.423	0.528	0.16	0.48	0.18	3.0	1.48	0.56	5.6	6.1	3.4
1	1/0 AWG	0.335	0.420	0.17	0.47	0.18	3.7	1.57	0.46	5.3	7.7	3.5
1	2/0 AWG	0.266	0.331	0.18	0.44	0.17	4.7	1.68	0.37	5.1	9.7	3.6
1	3/0 AWG	0.211	0.266	0.19	0.42	0.16	6.0	1.81	0.31	4.9	12.2	3.8
1	4/0 AWG	0.167	0.210	0.21	0.41	0.15	7.5	1.94	0.26	4.7	15.3	3.9
1	250 MCM	0.141	0.177	0.22	0.40	0.15	8.9	2.07	0.23	4.5	18.1	4.1
1	350 MCM	0.101	0.128	0.25	0.38	0.14	12.4	2.32	0.19	4.3	25.4	4.4
1	500 MCM	0.071	0.092	0.28	0.35	0.13	17.7	2.62	0.16	4.1	36.2	4.8
1	600 MCM	0.059	0.076	0.31	0.35	0.13	21.3	2.88	0.15	3.8	43.5	5.1
1	750 MCM	0.047	0.066	0.33	0.34	0.13	26.6	3.11	0.14	3.7	54.4	5.4
1	1000 MCM	0.035	0.052	0.37	0.33	0.12	35.4	3.46	0.13	3.6	72.5	5.9

100% insulation:

No. of Cores	Core Cross sectional Area	Nom. DC Resistance at 25°C	Nom. AC Resistance at 90°C	Approx. Capacitance	Approx. Inductance	Approx. Reactance	Max. pulling tension on conductor	Charging Current per phase	Positive sequence impedance	Electric Stress at Conductor Screen	Short circuit rating	
											Phase conductor	Metallic screen
No.	AWG / MCM	Ω/km	Ω/km	μF/km	mH/km	Ω/km	kN	Amps/Km	Ohms/Km	kV/mm	kA/S	
1	2 AWG	0.531	0.666	0.17	0.48	0.18	2.4	1.58	0.69	6.5	4.8	2.9
1	1 AWG	0.423	0.528	0.18	0.46	0.17	3.0	1.68	0.56	6.2	6.1	3.0
1	1/0 AWG	0.335	0.420	0.19	0.45	0.17	3.7	1.80	0.45	6.0	7.7	3.1
1	2/0 AWG	0.266	0.331	0.21	0.42	0.16	4.7	1.94	0.37	5.7	9.7	3.2
1	3/0 AWG	0.211	0.266	0.22	0.41	0.15	6.0	2.08	0.31	5.5	12.2	3.4
1	4/0 AWG	0.167	0.210	0.24	0.39	0.15	7.5	2.25	0.26	5.3	15.3	3.6
1	250 MCM	0.141	0.177	0.26	0.38	0.14	8.9	2.41	0.23	5.1	18.1	3.7
1	350 MCM	0.101	0.128	0.29	0.36	0.14	12.4	2.70	0.19	4.9	25.4	4.0
1	500 MCM	0.071	0.092	0.33	0.34	0.13	17.7	3.07	0.16	4.7	36.2	4.4
1	600 MCM	0.059	0.076	0.35	0.34	0.13	21.3	3.32	0.15	4.5	43.5	4.7
1	750 MCM	0.047	0.066	0.38	0.33	0.12	26.6	3.61	0.14	4.4	54.4	5.0
1	1000 MCM	0.035	0.052	0.43	0.31	0.12	35.4	4.03	0.13	4.3	72.5	5.4



OUR CERTIFICATION
ISO 9001 | ISO 14001 | ISO 45001



OUR CERTIFICATION
ISO 9001 | ISO 14001 | ISO 45001



POLYCAB MV SC SCR ICEA S-93-639 35KV
MV Cable with Copper Conductor, EPR Insulation and Copper Screen

POLYCAB MV SC SCR ICEA S-93-639 35KV
MV Cable with Copper Conductor, EPR Insulation and Copper Screen

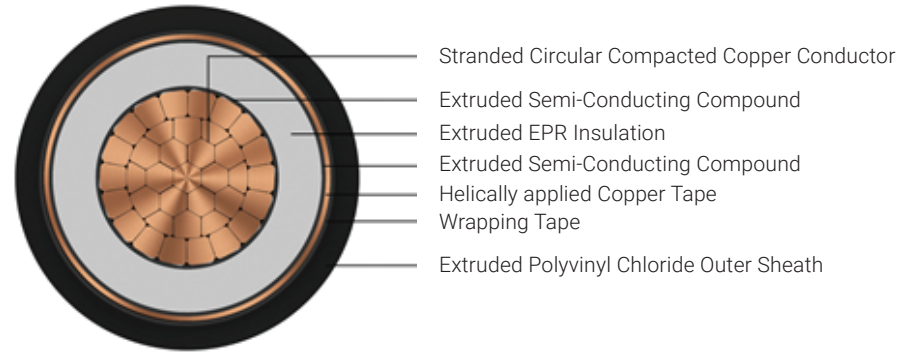

Outstanding Features

- Flame retardant
- High life
- Sunlight resistant
- Oil, Acid and Alkalies resistant
- Corona resistant
- Treeing resistant
- Moisture resistant

Application

POLYCAB MV 35KV EPR insulated with Copper conductor single core cable is suitable to use in conduits, ducts, troughs, trays, direct burial in wet and dry conditions for power supply to wide networks.

Voltage Rating

Nominal Voltage: 35kV AC

Operation Temperature

Operating temperature: -35°C to +105°C
Emergency operating temperature: 140°C
Max. Short Circuit Temperature: 250°C

Construction

- Conductor: Circular Compacted Copper conductor as per ASTM B496
- Conductor Screen: Extruded Semi-conductive compound
- Insulation: Extruded EPR (TR-XLPE will be provided on demand)
- Insulation Screen: Extruded Semi-conductive compound
- Metallic Insulation Screen: Helically applied copper tape (Round wire / Corrugated copper screen will be provided on demand)
- Outer Sheath: Extruded Polyvinyl Chloride, Colour: Black (Alternative Sheath: CPE Outer Sheath or LSZH Outer sheath, and parameters will change accordingly)

Bending Radius: 12D

D is overall diameter of cable

Standard and References:

- ASTM B496
- ICEA S-93-639 (NEMA WC-74)
- UL 1072
- UL 1685 / FT-1
- IEEE 1202
- UL 2556

Voltage Rating (kV AC)	High Voltage Test (kV AC)	
	100% level	133% level
35	69	84

Compliance

- Conductor resistance ICEA S-93-639
- Insulation resistance ICEA S-93-639
- Vertical Tray Flame UL 1685
- Smoke release UL 1685
- Flame Test IEEE 1202



DIMENSIONS, WEIGHT AND AMPACITY:

133% insulation:

Product Code	No. of Cores	Core Cross sectional Area	Nominal Diameter			Weight (Approx.) Kg/Km	Current rating *	
			Under metallic screen	Over metallic screen	Overall		Directly buried in ground	In air
	No.	AWG / MCM	mm	mm	mm	Amps		
MVIC46CRUAYF001C1X0AA001P	1	1/0 AWG	32.4	32.9	37.0	1850	185	285
MVIC46CRUAYF001C2X0AA001P	1	2/0 AWG	33.4	33.9	38.0	2050	215	330
MVIC46CRUAYF001C3X0AA001P	1	3/0 AWG	34.6	35.1	39.0	2250	245	385
MVIC46CRUAYF001C4X0AA001P	1	4/0 AWG	35.9	36.4	40.5	2550	285	445
MVIC46CRUAYF001C250CA001P	1	250 MCM	37.2	37.7	42.0	2800	315	500
MVIC46CRUAYF001C350CA001P	1	350 MCM	39.6	40.1	44.0	3400	385	625
MVIC46CRUAYF001C500CA001P	1	500 MCM	42.7	43.2	48.5	4400	470	765
MVIC46CRUAYF001C600CA001P	1	600 MCM	45.2	45.7	51.5	5050	520	855
MVIC46CRUAYF001C750CA001P	1	750 MCM	47.6	48.1	53.5	5900	585	970
MVIC46CRUAYF001C01KCA001P	1	1000 MCM	51.2	51.7	57.5	7250	675	1155

100% insulation (5kV):

Product Code	No. of Cores	Core Cross sectional Area	Nominal Diameter			Weight (Approx.) Kg/Km	Current rating *	
			Under metallic screen	Over metallic screen	Overall		Directly buried in ground	In air
	No.	AWG / MCM	mm	mm	mm	Amps		
MVIC46CRUAYF001C1X0AA002P	1	1/0 AWG	28.5	29.1	33.0	1600	185	285
MVIC46CRUAYF001C2X0AA002P	1	2/0 AWG	29.6	30.1	34.0	1750	215	330
MVIC46CRUAYF001C3X0AA002P	1	3/0 AWG	30.8	31.3	35.5	2000	245	385
MVIC46CRUAYF001C4X0AA002P	1	4/0 AWG	32.1	32.6	36.5	2250	285	445
MVIC46CRUAYF001C250CA002P	1	250 MCM	33.4	33.9	38.0	2500	315	500
MVIC46CRUAYF001C350CA002P	1	350 MCM	35.8	36.3	40.5	3050	385	625
MVIC46CRUAYF001C500CA002P	1	500 MCM	38.8	39.4	43.5	3900	470	765
MVIC46CRUAYF001C600CA002P	1	600 MCM	40.9	41.4	47.0	4600	520	855
MVIC46CRUAYF001C750CA002P	1	750 MCM	43.3	43.8	49.5	5450	585	970
MVIC46CRUAYF001C01KCA002P	1	1000 MCM	46.8	47.3	53.0	6750	675	1155

* Current Rating based on Table 310.16 (20°C Ambient Ground Temperature) and Table 310.17 (30°C Ambient Air Temperature) of National Electric Code



POLYCAB MV SC SCR ICEA S-93-639 35KV
MV Cable with Copper Conductor, EPR Insulation and Copper Screen

ELECTRICAL CHARACTERISTICS:

133% insulation:

No. of Cores	Core Cross sectional Area	Nom. DC Resistance at 25°C	Nom. AC Resistance at 90°C	Approx. Capacitance	Approx. Inductance	Approx. Reactance	Max. pulling tension on conductor	Charging Current per phase	Positive sequence impedance	Electric Stress at Conductor Screen	Short circuit rating	
											Phase conductor	Metallic screen
No.	AWG / MCM	Ω/km	Ω/km	μF/km	mH/km	Ω/km	kN	Amps/Km	Ohms/Km	kV/mm	kA/S	
1	1/0 AWG	0.335	0.420	0.14	0.50	0.19	3.7	1.87	0.46	6.4	7.7	4.1
1	2/0 AWG	0.266	0.331	0.15	0.47	0.18	4.7	1.99	0.38	6.1	9.7	4.3
1	3/0 AWG	0.211	0.266	0.16	0.45	0.17	6.0	2.12	0.32	5.8	12.2	4.4
1	4/0 AWG	0.167	0.210	0.17	0.44	0.16	7.5	2.27	0.27	5.5	15.3	4.6
1	250 MCM	0.141	0.177	0.18	0.42	0.16	8.9	2.41	0.24	5.3	18.1	4.7
1	350 MCM	0.101	0.128	0.20	0.40	0.15	12.4	2.68	0.20	5.0	25.4	5.0
1	500 MCM	0.071	0.092	0.23	0.38	0.15	17.7	3.01	0.17	4.7	36.2	5.4
1	600 MCM	0.059	0.076	0.25	0.38	0.14	21.3	3.28	0.16	4.5	43.5	5.7
1	750 MCM	0.047	0.066	0.27	0.36	0.14	26.6	3.54	0.15	4.4	54.4	6.1
1	1000 MCM	0.035	0.052	0.30	0.35	0.13	35.4	3.91	0.14	4.2	72.5	6.5

100% insulation:

No. of Cores	Core Cross sectional Area	Nom. DC Resistance at 25°C	Nom. AC Resistance at 90°C	Approx. Capacitance	Approx. Inductance	Approx. Reactance	Max. pulling tension on conductor	Charging Current per phase	Positive sequence impedance	Electric Stress at Conductor Screen	Short circuit rating	
											Phase conductor	Metallic screen
No.	AWG / MCM	Ω/km	Ω/km	μF/km	mH/km	Ω/km	kN	Amps/Km	Ohms/Km	kV/mm	kA/S	
1	1/0 AWG	0.335	0.420	0.16	0.47	0.18	3.7	2.10	0.46	7.1	7.7	3.7
1	2/0 AWG	0.266	0.331	0.17	0.45	0.17	4.7	2.25	0.37	6.8	9.7	3.8
1	3/0 AWG	0.211	0.266	0.18	0.43	0.16	6.0	2.41	0.31	6.5	12.2	3.9
1	4/0 AWG	0.167	0.210	0.20	0.42	0.16	7.5	2.58	0.26	6.2	15.3	4.1
1	250 MCM	0.141	0.177	0.21	0.41	0.15	8.9	2.75	0.23	6.0	18.1	4.3
1	350 MCM	0.101	0.128	0.23	0.38	0.14	12.4	3.07	0.19	5.7	25.4	4.6
1	500 MCM	0.071	0.092	0.26	0.36	0.14	17.7	3.47	0.16	5.4	36.2	4.9
1	600 MCM	0.059	0.076	0.28	0.36	0.14	21.3	3.73	0.16	5.2	43.5	5.2
1	750 MCM	0.047	0.066	0.31	0.35	0.13	26.6	4.04	0.15	5.1	54.4	5.5
1	1000 MCM	0.035	0.052	0.34	0.33	0.12	35.4	4.49	0.14	4.9	72.5	5.9

POLYCAB MV SC SCR ICEA S-93-639 5KV (or) 8 KV
MV Cable with Aluminium Conductor, EPR Insulation and Copper Screen

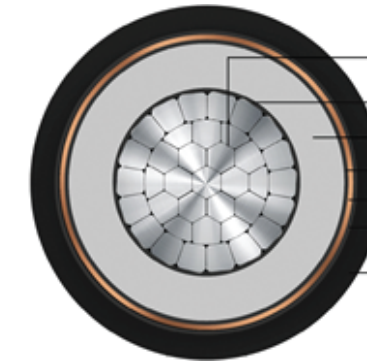

- Stranded Circular Compacted Aluminium Conductor
- Extruded Semi-Conducting Compound
- Extruded EPR Insulation
- Extruded Semi-Conducting Compound
- Helically Applied Copper Tape
- Wrapping Tape
- Extruded Polyvinyl Chloride Outer Sheath

Outstanding Features

- Flame retardant
- High life
- Sunlight resistant
- Oil, Acid and Alkalies resistant
- Corona resistant
- Treeing resistant
- Moisture resistant

Application

POLYCAB MV 5 KV EPR insulated with Aluminium conductor single core cable is suitable to use in conduits, ducts, troughs, trays, direct burial in wet and dry conditions for power supply to wide networks.

Voltage Rating

Nominal Voltage: 5 kV AC (100% / 133%) or 8 kV AC (100%)

Operation Temperature

Operating temperature: -35°C to +105°C
 Emergency operating temperature: 140°C
 Max. Short Circuit Temperature: 250°C

Construction

- Conductor: Circular Compacted Aluminium conductor as per ASTM B496
- Conductor Screen: Extruded Semi-conductive compound
- Insulation: Extruded EPR (TR-XLPE will be provided on demand)
- Insulation Screen: Extruded Semi-conductive compound
- Metallic Insulation Screen: Helically applied copper tape (*Round wire / Corrugated copper screen will be provided on demand*)
- Outer Sheath: Extruded Polyvinyl Chloride, Colour: Black (*Alternative Sheath: CPE Outer Sheath or LSZH Outer sheath, and parameters will change accordingly*)

Bending Radius: 12D

D is overall diameter of cable

Standard and References:

- ASTM B496
- ICEA S-93-639 (NEMA WC-74)
- UL 1072
- UL 1685 / FT-1
- IEEE 1202
- UL 2556

Voltage Rating (kV AC)	High Voltage Test (kV AC)	Min. Partial discharge test (kV AC)	
		100% level	133% level
5	18	4	5
8	23	6	8

Compliance

- Conductor resistance ICEA S-93-639
- Insulation resistance ICEA S-93-639
- Vertical Tray Flame UL 1685
- Smoke Release UL 1685
- Flame Test IEEE 1202



OUR CERTIFICATION
 ISO 9001 | ISO 14001 | ISO 45001



OUR CERTIFICATION
 ISO 9001 | ISO 14001 | ISO 45001



DIMENSIONS, WEIGHT AND AMPACITY:

133% insulation (5kV) and 100% insulation (8kV):

Product Code	No. of Cores	Core Cross sectional Area	Nominal Diameter			Weight (Approx.) Kg/Km	Current rating *	
			Under metallic screen	Over metallic screen	Overall		Directly buried in ground	In air
	No.	AWG / MCM	mm	mm	mm	Amps		
MVIC36ARUAYF001C002AA001P	1	2 AWG	15.1	15.6	19.0	450	110	165
MVIC36ARUAYF001C001AA001P	1	1 AWG	15.9	16.4	19.5	500	125	195
MVIC36ARUAYF001C1X0AA001P	1	1/0 AWG	16.9	17.4	20.5	550	150	225
MVIC36ARUAYF001C2X0AA001P	1	2/0 AWG	17.9	18.4	21.5	650	165	260
MVIC36ARUAYF001C3X0AA001P	1	3/0 AWG	19.1	19.6	23.5	750	190	300
MVIC36ARUAYF001C4X0AA001P	1	4/0 AWG	20.4	20.9	25.0	850	225	345
MVIC36ARUAYF001C250CA001P	1	250 MCM	21.7	22.2	26.5	950	250	390
MVIC36ARUAYF001C350CA001P	1	350 MCM	24.1	24.6	28.5	1150	285	490
MVIC36ARUAYF001C500CA001P	1	500 MCM	27.2	27.7	31.5	1450	385	600
MVIC36ARUAYF001C600CA001P	1	600 MCM	29.7	30.2	34.5	1700	420	675
MVIC36ARUAYF001C750CA001P	1	750 MCM	32.1	32.7	36.5	2000	475	770
MVIC36ARUAYF001C01KCA001P	1	1000 MCM	35.7	36.2	40.0	2450	545	925

100% insulation (5kV):

Product Code	No. of Cores	Core Cross sectional Area	Nominal Diameter			Weight (Approx.) Kg/Km	Current rating *	
			Under metallic screen	Over metallic screen	Overall		Directly buried in ground	In air
	No.	AWG / MCM	mm	mm	mm	Amps		
MVIC36ARUAYF001C002AA002P	1	2 AWG	13.8	14.3	17.5	400	110	165
MVIC36ARUAYF001C001AA002P	1	1 AWG	14.7	15.2	18.5	450	125	195
MVIC36ARUAYF001C1X0AA002P	1	1/0 AWG	15.6	16.1	19.5	500	150	225
MVIC36ARUAYF001C2X0AA002P	1	2/0 AWG	16.6	17.2	20.5	550	165	260
MVIC36ARUAYF001C3X0AA002P	1	3/0 AWG	17.8	18.3	21.5	650	190	300
MVIC36ARUAYF001C4X0AA002P	1	4/0 AWG	19.2	19.7	23.5	800	225	345
MVIC36ARUAYF001C250CA002P	1	250 MCM	20.4	20.9	25.0	900	250	390
MVIC36ARUAYF001C350CA002P	1	350 MCM	22.9	23.4	27.5	1100	285	490
MVIC36ARUAYF001C500CA002P	1	500 MCM	25.9	26.4	30.5	1350	385	600
MVIC36ARUAYF001C600CA002P	1	600 MCM	27.9	28.4	32.5	1550	420	675
MVIC36ARUAYF001C750CA002P	1	750 MCM	30.3	30.8	35.0	1850	475	770
MVIC36ARUAYF001C01KCA002P	1	1000 MCM	33.8	34.3	38.5	2300	545	925

* Current Rating based on Table 310.16 (20°C Ambient Ground Temperature) and Table 310.17 (30°C Ambient Air Temperature) of National Electric Code

ELECTRICAL CHARACTERISTICS:

133% insulation:

No. of Cores	Core Cross sectional Area	Nom. DC Resistance at 25°C	Nom. AC Resistance at 90°C	Approx. Capacitance	Approx. Inductance	Approx. Reactance	Max. pulling tension on conductor	Charging Current per phase	Positive sequence impedance	Electric Stress at Conductor Screen	Short circuit rating	
											Phase conductor	Metallic screen
No.	AWG / MCM	Ω/km	Ω/km	μF/km	mH/km	Ω/km	kN	Amps/Km	Ohms/Km	kV/mm	kA/S	
1	2 AWG	0.531	0.666	0.30	0.41	0.15	1.7	0.56	2.36	2.1	3.0	2.0
1	1 AWG	0.423	0.528	0.32	0.39	0.15	2.1	0.60	2.07	2.1	3.8	2.1
1	1/0 AWG	0.335	0.420	0.35	0.38	0.14	2.7	0.66	1.82	2.0	4.8	2.2
1	2/0 AWG	0.266	0.331	0.38	0.36	0.13	3.4	0.71	1.62	1.9	6.0	2.3
1	3/0 AWG	0.211	0.266	0.41	0.35	0.13	4.3	0.78	1.44	1.9	7.6	2.5
1	4/0 AWG	0.167	0.210	0.45	0.34	0.13	5.4	0.85	1.28	1.9	9.6	2.6
1	250 MCM	0.141	0.177	0.49	0.33	0.13	6.4	0.92	1.18	1.8	11.3	2.8
1	350 MCM	0.101	0.128	0.56	0.31	0.12	8.9	1.05	1.01	1.7	15.9	3.1
1	500 MCM	0.071	0.092	0.64	0.30	0.11	12.8	1.21	0.86	1.7	22.6	3.5
1	600 MCM	0.059	0.076	0.72	0.30	0.11	15.3	1.35	0.78	1.5	27.2	3.8
1	750 MCM	0.047	0.066	0.79	0.29	0.11	19.2	1.48	0.70	1.5	34.0	4.1
1	1000 MCM	0.035	0.052	0.89	0.27	0.10	25.5	1.67	0.62	1.5	45.3	4.5

100% insulation:

No. of Cores	Core Cross sectional Area	Nom. DC Resistance at 25°C	Nom. AC Resistance at 90°C	Approx. Capacitance	Approx. Inductance	Approx. Reactance	Max. pulling tension on conductor	Charging Current per phase	Positive sequence impedance	Electric Stress at Conductor Screen	Short circuit rating	
											Phase conductor	Metallic screen
No.	AWG / MCM	Ω/km	Ω/km	μF/km	mH/km	Ω/km	kN	Amps/Km	Ohms/Km	kV/mm	kA/S	
1	2 AWG	0.531	0.666	0.36	0.39	0.15	1.7	0.68	2.47	2.5	3.0	1.8
1	1 AWG	0.423	0.528	0.39	0.38	0.14	2.1	0.73	2.17	2.4	3.8	1.9
1	1/0 AWG	0.335	0.420	0.42	0.37	0.14	2.7	0.80	1.91	2.4	4.8	2.0
1	2/0 AWG	0.266	0.331	0.46	0.35	0.13	3.4	0.87	1.69	2.3	6.0	2.2
1	3/0 AWG	0.211	0.266	0.51	0.33	0.13	4.3	0.95	1.51	2.2	7.6	2.3
1	4/0 AWG	0.167	0.210	0.56	0.33	0.12	5.4	1.05	1.34	2.2	9.6	2.5
1	250 MCM	0.141	0.177	0.60	0.32	0.12	6.4	1.14	1.23	2.1	11.3	2.6
1	350 MCM	0.101	0.128	0.69	0.30	0.11	8.9	1.30	1.05	2.0	15.9	2.9
1	500 MCM	0.071	0.092	0.80	0.29	0.11	12.8	1.51	0.89	2.0	22.6	3.3
1	600 MCM	0.059	0.076	0.88	0.28	0.11	15.3	1.65	0.82	1.9	27.2	3.6
1	750 MCM	0.047	0.066	0.96	0.28	0.10	19.2	1.82	0.74	1.9	34.0	3.9
1	1000 MCM	0.035	0.052	1.09	0.27	0.10	25.5	2.06	0.65	1.9	45.3	4.3



OUR CERTIFICATION
ISO 9001 | ISO 14001 | ISO 45001



OUR CERTIFICATION
ISO 9001 | ISO 14001 | ISO 45001



POLYCAB MV SC SCR ICEA S-93-639 8KV
MV Cable with Aluminium Conductor, EPR Insulation and Copper Screen

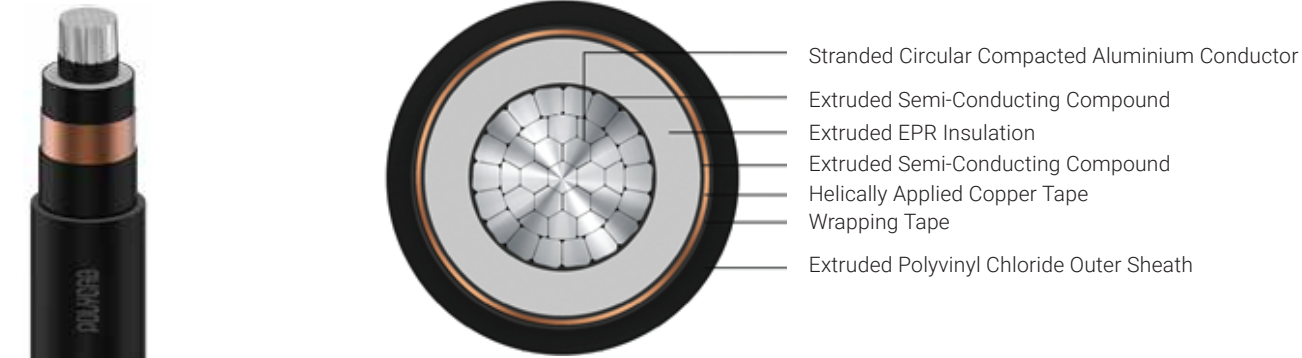

Outstanding Features

- Flame retardant
- High life
- Sunlight resistant
- Oil, Acid and Alkalies resistant
- Corona resistant
- Treeing resistant
- Moisture resistant

Application

POLYCAB MV 8KV EPR insulated with Aluminium conductor single core cable is suitable to use in conduits, ducts, troughs, trays, direct burial in wet and dry conditions for power supply to wide networks.

Voltage Rating

Nominal Voltage: 8kV AC

Operation Temperature

Operating temperature: -35°C to +105°C
Emergency operating temperature: 140°C
Max. Short Circuit Temperature: 250°C

Construction

- Conductor: Circular Compacted Aluminium conductor as per ASTM B496
- Conductor Screen: Extruded Semi-conductive compound
- Insulation: Extruded EPR (TR-XLPE will be provided on demand)
- Insulation Screen: Extruded Semi-conductive compound
- Metallic Insulation Screen: Helically applied copper tape (Round wire / Corrugated copper screen will be provided on demand)
- Outer Sheath: Extruded Polyvinyl Chloride, Colour: Black (Alternative Sheath: CPE Outer Sheath or LSZH Outer sheath, and parameters will change accordingly)

Bending Radius: 12D

D is overall diameter of cable

Standard and References:

ASTM B496
ICEA S-93-639 (NEMA WC-74)
UL 1072
UL 1685 / FT-1
IEEE 1202
UL 2556

Voltage Rating (kV AC)	High Voltage Test (kV AC)		Min. Partial discharge test (kV AC)	
	100% level	133% level	100% level	133% level
8	23	28	6	8

Compliance

- Conductor resistance ICEA S-93-639
- Insulation resistance ICEA S-93-639
- Vertical Tray Flame UL 1685
- Smoke Release UL 1685
- Flame Test IEEE 1202



POLYCAB MV SC SCR ICEA S-93-639 8KV
MV Cable with Aluminium Conductor, EPR Insulation and Copper Screen

DIMENSIONS, WEIGHT AND AMPACITY:

133% insulation:

Product Code	No. of Cores	Core Cross sectional Area	Nominal Diameter			Weight (Approx.) Kg/Km	Current rating *	
			Under metallic screen	Over metallic screen	Overall		Directly buried in ground	In air
	No.	AWG / MCM	mm	mm	mm	Amps		
MVIC48ARUAYF001C002AA001P	1	2 AWG	16.4	16.9	20.0	500	110	165
MVIC48ARUAYF001C001AA001P	1	1 AWG	17.2	17.7	21.0	550	125	195
MVIC48ARUAYF001C1X0AA001P	1	1/0 AWG	18.1	18.6	22.5	650	150	225
MVIC48ARUAYF001C2X0AA001P	1	2/0 AWG	19.2	19.7	24.0	700	165	260
MVIC48ARUAYF001C3X0AA001P	1	3/0 AWG	20.4	20.9	25.0	800	190	300
MVIC48ARUAYF001C4X0AA001P	1	4/0 AWG	21.7	22.2	26.5	900	225	345
MVIC48ARUAYF001C250CA001P	1	250 MCM	16.4	16.9	20.0	500	250	390
MVIC48ARUAYF001C350CA001P	1	350 MCM	17.2	17.7	21.0	550	285	490
MVIC48ARUAYF001C500CA001P	1	500 MCM	18.1	18.6	22.5	650	385	600
MVIC48ARUAYF001C600CA001P	1	600 MCM	19.2	19.7	24.0	700	420	675
MVIC48ARUAYF001C750CA001P	1	750 MCM	20.4	20.9	25.0	800	475	770
MVIC48ARUAYF001C01KCA001P	1	1000 MCM	21.7	22.2	26.5	900	545	925

100% insulation:

Product Code	No. of Cores	Core Cross sectional Area	Nominal Diameter			Weight (Approx.) Kg/Km	Current rating *	
			Under metallic screen	Over metallic screen	Overall		Directly buried in ground	In air
	No.	AWG / MCM	mm	mm	mm	Amps		
MVIC48ARUAYF001C002AA002P	1	2 AWG	15.1	15.6	19.0	450	110	165
MVIC48ARUAYF001C001AA002P	1	1 AWG	15.9	16.4	19.5	500	125	195
MVIC48ARUAYF001C1X0AA002P	1	1/0 AWG	16.9	17.4	20.5	550	150	225
MVIC48ARUAYF001C2X0AA002P	1	2/0 AWG	17.9	18.4	21.5	650	165	260
MVIC48ARUAYF001C3X0AA002P	1	3/0 AWG	19.1	19.6	23.5	750	190	300
MVIC48ARUAYF001C4X0AA002P	1	4/0 AWG	20.4	20.9	25.0	850	225	345
MVIC48ARUAYF001C250CA002P	1	250 MCM	21.7	22.2	26.5	950	250	390
MVIC48ARUAYF001C350CA002P	1	350 MCM	24.1	24.6	28.5	1150	285	490
MVIC48ARUAYF001C500CA002P	1	500 MCM	27.2	27.7	31.5	1450	385	600
MVIC48ARUAYF001C600CA002P	1	600 MCM	29.7	30.2	34.5	1700	420	675
MVIC48ARUAYF001C750CA002P	1	750 MCM	32.1	32.7	36.5	2000	475	770
MVIC48ARUAYF001C01KCA002P	1	1000 MCM	35.7	36.2	40.0	2450	545	925

* Current Rating based on Table 310.16 (20°C Ambient Ground Temperature) and Table 310.17 (30°C Ambient Air Temperature) of National Electric Code



POLYCAB MV SC SCR ICEA S-93-639 8KV
MV Cable with Aluminium Conductor, EPR Insulation and Copper Screen

ELECTRICAL CHARACTERISTICS:

133% insulation:

No. of Cores	Core Cross sectional Area	Nom. DC Resistance at 25°C	Nom. AC Resistance at 90°C	Approx. Capacitance	Approx. Inductance	Approx. Reactance	Max. pulling tension on conductor	Charging Current per phase	Positive sequence impedance	Electric Stress at Conductor Screen	Short circuit rating	
											Phase conductor	Metallic screen
No.	AWG / MCM	Ω/km	Ω/km	μF/km	mH/km	Ω/km	kN	Amps/Km	Ohms/Km	kV/mm	kA/S	
1	2 AWG	0.531	0.666	0.26	0.42	0.16	1.7	0.77	1.11	3.0	3.0	2.1
1	1 AWG	0.423	0.528	0.28	0.41	0.15	2.1	0.83	0.89	2.9	3.8	2.2
1	1/0 AWG	0.335	0.420	0.30	0.40	0.15	2.7	0.90	0.71	2.8	4.8	2.3
1	2/0 AWG	0.266	0.331	0.32	0.38	0.14	3.4	0.98	0.57	2.7	6.0	2.5
1	3/0 AWG	0.211	0.266	0.35	0.36	0.14	4.3	1.06	0.46	2.7	7.6	2.6
1	4/0 AWG	0.167	0.210	0.38	0.35	0.13	5.4	1.16	0.37	2.6	9.6	2.8
1	250 MCM	0.141	0.177	0.41	0.34	0.13	6.4	1.25	0.32	2.5	11.3	3.0
1	350 MCM	0.101	0.128	0.47	0.32	0.12	8.9	1.42	0.24	2.4	15.9	3.3
1	500 MCM	0.071	0.092	0.54	0.31	0.12	12.8	1.64	0.19	2.3	22.6	3.6
1	600 MCM	0.059	0.076	0.59	0.30	0.11	15.3	1.78	0.17	2.2	27.2	3.9
1	750 MCM	0.047	0.066	0.65	0.29	0.11	19.2	1.95	0.15	2.2	34.0	4.2
1	1000 MCM	0.035	0.052	0.73	0.28	0.10	25.5	2.20	0.13	2.2	45.3	4.6

100% insulation:

No. of Cores	Core Cross sectional Area	Nom. DC Resistance at 25°C	Nom. AC Resistance at 90°C	Approx. Capacitance	Approx. Inductance	Approx. Reactance	Max. pulling tension on conductor	Charging Current per phase	Positive sequence impedance	Electric Stress at Conductor Screen	Short circuit rating	
											Phase conductor	Metallic screen
No.	AWG / MCM	Ω/km	Ω/km	μF/km	mH/km	Ω/km	kN	Amps/Km	Ohms/Km	kV/mm	kA/S	
1	2 AWG	0.531	0.666	0.30	0.41	0.15	1.7	0.56	2.36	2.1	3.0	2.0
1	1 AWG	0.423	0.528	0.32	0.39	0.15	2.1	0.60	2.07	2.1	3.8	2.1
1	1/0 AWG	0.335	0.420	0.35	0.38	0.14	2.7	0.66	1.82	2.0	4.8	2.2
1	2/0 AWG	0.266	0.331	0.38	0.36	0.13	3.4	0.71	1.62	1.9	6.0	2.3
1	3/0 AWG	0.211	0.266	0.41	0.35	0.13	4.3	0.78	1.44	1.9	7.6	2.5
1	4/0 AWG	0.167	0.210	0.45	0.34	0.13	5.4	0.85	1.28	1.9	9.6	2.6
1	250 MCM	0.141	0.177	0.49	0.33	0.13	6.4	0.92	1.18	1.8	11.3	2.8
1	350 MCM	0.101	0.128	0.56	0.31	0.12	8.9	1.05	1.01	1.7	15.9	3.1
1	500 MCM	0.071	0.092	0.64	0.30	0.11	12.8	1.21	0.86	1.7	22.6	3.5
1	600 MCM	0.059	0.076	0.72	0.30	0.11	15.3	1.35	0.78	1.5	27.2	3.8
1	750 MCM	0.047	0.066	0.79	0.29	0.11	19.2	1.48	0.70	1.5	34.0	4.1
1	1000 MCM	0.035	0.052	0.89	0.27	0.10	25.5	1.67	0.62	1.5	45.3	4.5

POLYCAB MV SC SCR ICEA S-93-639 15KV
MV Cable with Aluminium Conductor, EPR Insulation and Copper Screen

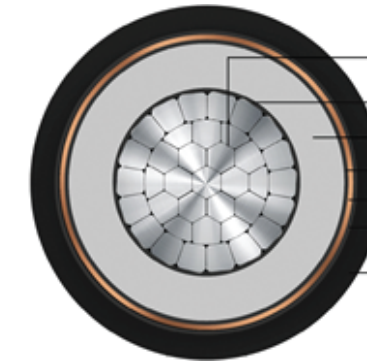

- Stranded Circular Compacted Aluminium Conductor
- Extruded Semi-Conducting Compound
- Extruded EPR Insulation
- Extruded Semi-Conducting Compound
- Helically Applied Copper Tape
- Wrapping Tape
- Extruded Polyvinyl Chloride Outer Sheath

Outstanding Features

- Flame retardant
- High life
- Sunlight resistant
- Oil, Acid and Alkalies resistant
- Corona resistant
- Treeing resistant
- Moisture resistant

Application

POLYCAB MV 15KV EPR insulated with Aluminium conductor single core cable is suitable to use in conduits, ducts, troughs, trays, direct burial in wet and dry conditions for power supply to wide networks.

Voltage Rating

Nominal Voltage: 15kV AC

Operation Temperature

Operating temperature: -35°C to +105°C
 Emergency operating temperature: 140°C
 Max. Short Circuit Temperature: 250°C

Construction

- Conductor: Circular Compacted Aluminium conductor as per ASTM B496
- Conductor Screen: Extruded Semi-conductive compound
- Insulation: Extruded EPR
- Insulation: Extruded EPR (TR-XLPE will be provided on demand)
- Insulation Screen: Extruded Semi-conductive compound
- Metallic Insulation Screen: Helically applied copper tape (*Round wire / Corrugated copper screen will be provided on demand*)
- Outer Sheath: Extruded Polyvinyl Chloride, Colour: Black (*Alternative Sheath: CPE Outer Sheath or LSZH Outer sheath, and parameters will change accordingly*)

Bending Radius: 12D

D is overall diameter of cable

Standard and References:

- ASTM B496
- ICEA S-93-639 (NEMA WC-74)
- UL 1072
- UL 1685 / FT-1
- IEEE 1202
- UL 2556

Voltage Rating (kV AC)	High Voltage Test (kV AC)		Min. Partial discharge test (kV AC)	
	100% level	133% level	100% level	133% level
15	35	44	11	15

Compliance

- Conductor resistance ICEA S-93-639
- Insulation resistance ICEA S-93-639
- Vertical Tray Flame UL 1685
- Smoke Release UL 1685
- Flame Test IEEE 1202



OUR CERTIFICATION
 ISO 9001 | ISO 14001 | ISO 45001



OUR CERTIFICATION
 ISO 9001 | ISO 14001 | ISO 45001



DIMENSIONS, WEIGHT AND AMPACITY:

133% insulation:

Product Code	No. of Cores	Core Cross sectional Area	Nominal Diameter			Weight (Approx.) Kg/Km	Current rating *	
			Under metallic screen	Over metallic screen	Overall		Directly buried in ground	In air
	No.	AWG / MCM	mm	mm	mm	Amps		
MVIC37ARUAYF001C002AA001P	1	2 AWG	20.4	20.9	25.0	750	110	165
MVIC37ARUAYF001C001AA001P	1	1 AWG	21.3	21.8	26.0	800	125	195
MVIC37ARUAYF001C1X0AA001P	1	1/0 AWG	22.2	22.7	27.0	850	150	225
MVIC37ARUAYF001C2X0AA001P	1	2/0 AWG	23.3	23.8	28.0	950	165	260
MVIC37ARUAYF001C3X0AA001P	1	3/0 AWG	24.4	24.9	29.0	1050	190	300
MVIC37ARUAYF001C4X0AA001P	1	4/0 AWG	25.8	26.3	30.5	1150	225	345
MVIC37ARUAYF001C250CA001P	1	250 MCM	27.0	27.6	31.5	1250	250	390
MVIC37ARUAYF001C350CA001P	1	350 MCM	29.5	30.0	34.0	1500	285	490
MVIC37ARUAYF001C500CA001P	1	500 MCM	32.5	33.0	37.0	1800	385	600
MVIC37ARUAYF001C600CA001P	1	600 MCM	35.1	35.6	39.5	2050	420	675
MVIC37ARUAYF001C750CA001P	1	750 MCM	37.5	38.0	42.0	2400	475	770
MVIC37ARUAYF001C01KCA001P	1	1000 MCM	41.0	41.5	47.0	3050	545	925

100% insulation:

Product Code	No. of Cores	Core Cross sectional Area	Nominal Diameter			Weight (Approx.) Kg/Km	Current rating *	
			Under metallic screen	Over metallic screen	Overall		Directly buried in ground	In air
	No.	AWG / MCM	mm	mm	mm	Amps		
MVIC37ARUAYF001C002AA002P	1	2 AWG	18.1	18.7	22.5	600	110	165
MVIC37ARUAYF001C001AA002P	1	1 AWG	19.0	19.5	23.5	700	125	195
MVIC37ARUAYF001C1X0AA002P	1	1/0 AWG	19.9	20.4	24.5	750	150	225
MVIC37ARUAYF001C2X0AA002P	1	2/0 AWG	21.0	21.5	25.5	800	165	260
MVIC37ARUAYF001C3X0AA002P	1	3/0 AWG	22.2	22.7	26.5	900	190	300
MVIC37ARUAYF001C4X0AA002P	1	4/0 AWG	23.5	24.0	28.0	1000	225	345
MVIC37ARUAYF001C250CA002P	1	250 MCM	24.8	25.3	29.5	1100	250	390
MVIC37ARUAYF001C350CA002P	1	350 MCM	27.2	27.7	31.5	1350	285	490
MVIC37ARUAYF001C500CA002P	1	500 MCM	30.2	30.7	35.0	1650	385	600
MVIC37ARUAYF001C600CA002P	1	600 MCM	32.2	32.7	37.0	1850	420	675
MVIC37ARUAYF001C750CA002P	1	750 MCM	34.6	35.1	39.0	2150	475	770
MVIC37ARUAYF001C01KCA002P	1	1000 MCM	38.2	38.7	44.5	2750	545	925

* Current Rating based on Table 310.16 (20°C Ambient Ground Temperature) and Table 310.17 (30°C Ambient Air Temperature) of National Electric Code

ELECTRICAL CHARACTERISTICS:

133% insulation:

No. of Cores	Core Cross sectional Area	Nom. DC Resistance at 25°C	Nom. AC Resistance at 90°C	Approx. Capacitance	Approx. Inductance	Approx. Reactance	Max. pulling tension on conductor	Charging Current per phase	Positive sequence impedance	Electric Stress at Conductor Screen	Short circuit rating	
											Phase conductor	Metallic screen
No.	AWG / MCM	Ω/km	Ω/km	μF/km	mH/km	Ω/km	kN	Amps/Km	Ohms/Km	kV/mm	kA/S	
1	2 AWG	0.531	0.666	0.19	0.46	0.18	1.7	1.05	1.11	4.3	3.0	2.6
1	1 AWG	0.423	0.528	0.20	0.45	0.17	2.1	1.13	0.89	4.1	3.8	2.7
1	1/0 AWG	0.335	0.420	0.21	0.43	0.16	2.7	1.21	0.71	4.0	4.8	2.9
1	2/0 AWG	0.266	0.331	0.23	0.41	0.15	3.4	1.30	0.57	3.8	6.0	3.0
1	3/0 AWG	0.211	0.266	0.25	0.39	0.15	4.3	1.41	0.46	3.7	7.6	3.1
1	4/0 AWG	0.167	0.210	0.27	0.38	0.14	5.4	1.52	0.38	3.6	9.6	3.3
1	250 MCM	0.141	0.177	0.29	0.37	0.14	6.4	1.64	0.33	3.4	11.3	3.5
1	350 MCM	0.101	0.128	0.33	0.35	0.13	8.9	1.84	0.25	3.3	15.9	3.8
1	500 MCM	0.071	0.092	0.37	0.33	0.12	12.8	2.11	0.19	3.2	22.6	4.1
1	600 MCM	0.059	0.076	0.41	0.32	0.12	15.3	2.33	0.17	3.0	27.2	4.5
1	750 MCM	0.047	0.066	0.45	0.31	0.12	19.2	2.53	0.16	2.9	34.0	4.8
1	1000 MCM	0.035	0.052	0.50	0.31	0.12	25.5	2.83	0.14	2.8	45.3	5.2

100% insulation:

No. of Cores	Core Cross sectional Area	Nom. DC Resistance at 25°C	Nom. AC Resistance at 90°C	Approx. Capacitance	Approx. Inductance	Approx. Reactance	Max. pulling tension on conductor	Charging Current per phase	Positive sequence impedance	Electric Stress at Conductor Screen	Short circuit rating	
											Phase conductor	Metallic screen
No.	AWG / MCM	Ω/km	Ω/km	μF/km	mH/km	Ω/km	kN	Amps/Km	Ohms/Km	kV/mm	kA/S	
1	2 AWG	0.531	0.666	0.22	0.44	0.17	1.7	1.23	1.11	4.9	3.0	2.3
1	1 AWG	0.423	0.528	0.23	0.43	0.16	2.1	1.32	0.89	4.8	3.8	2.5
1	1/0 AWG	0.335	0.420	0.25	0.41	0.16	2.7	1.43	0.71	4.6	4.8	2.6
1	2/0 AWG	0.266	0.331	0.27	0.39	0.15	3.4	1.54	0.57	4.4	6.0	2.7
1	3/0 AWG	0.211	0.266	0.30	0.38	0.14	4.3	1.67	0.46	4.3	7.6	2.9
1	4/0 AWG	0.167	0.210	0.32	0.36	0.14	5.4	1.81	0.37	4.2	9.6	3.0
1	250 MCM	0.141	0.177	0.35	0.35	0.13	6.4	1.95	0.32	4.0	11.3	3.2
1	350 MCM	0.101	0.128	0.39	0.33	0.13	8.9	2.22	0.25	3.9	15.9	3.5
1	500 MCM	0.071	0.092	0.45	0.32	0.12	12.8	2.54	0.19	3.7	22.6	3.9
1	600 MCM	0.059	0.076	0.49	0.31	0.12	15.3	2.76	0.17	3.6	27.2	4.1
1	750 MCM	0.047	0.066	0.53	0.30	0.11	19.2	3.01	0.15	3.5	34.0	4.4
1	1000 MCM	0.035	0.052	0.60	0.29	0.11	25.5	3.39	0.13	3.5	45.3	4.9



OUR CERTIFICATION
ISO 9001 | ISO 14001 | ISO 45001



OUR CERTIFICATION
ISO 9001 | ISO 14001 | ISO 45001



POLYCAB MV SC SCR ICEA S-93-639 25KV
MV Cable with Aluminium Conductor, EPR Insulation and Copper Screen

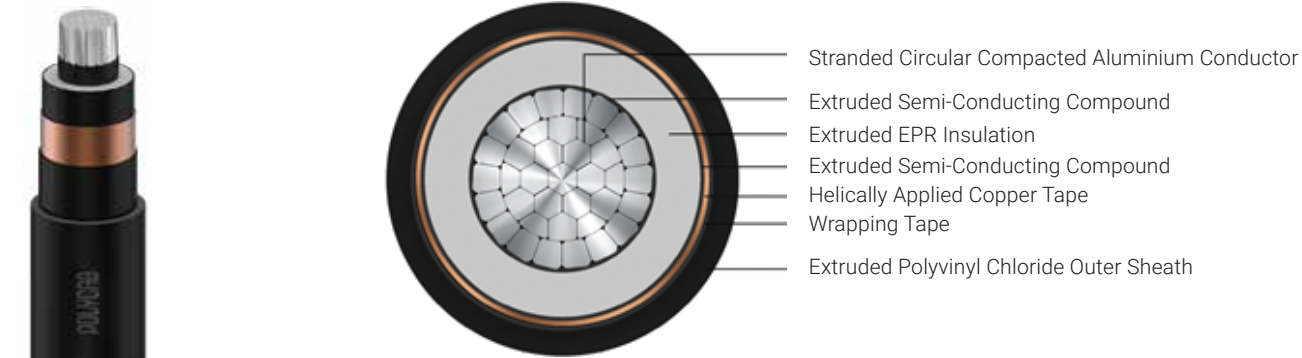

Outstanding Features

- Flame retardant
- High life
- Sunlight resistant
- Oil, Acid and Alkalies resistant
- Corona resistant
- Treeing resistant
- Moisture resistant

Application

POLYCAB MV 25KV EPR insulated with Aluminium conductor single core cable is suitable to use in conduits, ducts, troughs, trays, direct burial in wet and dry conditions for power supply to wide networks.

Voltage Rating

Nominal Voltage: 25kV AC

Operation Temperature

Operating temperature: -35°C to +105°C
Emergency operating temperature: 140°C
Max. Short Circuit Temperature: 250°C

Construction

- Conductor: Circular Compacted Aluminium conductor as per ASTM B496
- Conductor Screen: Extruded Semi-conductive compound
- Insulation: Extruded EPR (TR-XLPE will be provided on demand)
- Insulation Screen: Extruded Semi-conductive compound
- Metallic Insulation Screen: Helically applied copper tape (Round wire / Corrugated copper screen will be provided on demand)
- Outer Sheath: Extruded Polyvinyl Chloride, Colour: Black (Alternative Sheath: CPE Outer Sheath or LSZH Outer sheath, and parameters will change accordingly)

Bending Radius: 12D

D is overall diameter of cable

Standard and References:

- ASTM B496
- ICEA S-93-639 (NEMA WC-74)
- UL 1072
- UL 1685 / FT-1
- IEEE 1202
- UL 2556

Voltage Rating (kV AC)	High Voltage Test (kV AC)	
	100% level	133% level
25	52	64

Compliance

- Conductor resistance ICEA S-93-639
- Insulation resistance ICEA S-93-639
- Vertical Tray Flame UL 1685
- Smoke Release UL 1685
- Flame Test IEEE 1202



POLYCAB MV SC SCR ICEA S-93-639 25KV
MV Cable with Aluminium Conductor, EPR Insulation and Copper Screen

DIMENSIONS, WEIGHT AND AMPACITY:

133% insulation:

Product Code	No. of Cores	Core Cross sectional Area	Nominal Diameter			Weight (Approx.) Kg/Km	Current rating *	
			Under metallic screen	Over metallic screen	Overall		Directly buried in ground	In air
	No.	AWG / MCM	mm	mm	mm	Amps		
MVIC32ARUAYF001C002AA001P	1	2 AWG	25.5	26.0	30.0	1050	110	165
MVIC32ARUAYF001C001AA001P	1	1 AWG	26.3	26.9	31.0	1100	125	195
MVIC32ARUAYF001C1X0AA001P	1	1/0 AWG	27.3	27.8	32.0	1150	150	225
MVIC32ARUAYF001C2X0AA001P	1	2/0 AWG	28.3	28.8	33.0	1250	165	260
MVIC32ARUAYF001C3X0AA001P	1	3/0 AWG	29.5	30.0	34.0	1350	190	300
MVIC32ARUAYF001C4X0AA001P	1	4/0 AWG	30.8	31.3	35.5	1500	225	345
MVIC32ARUAYF001C250CA001P	1	250 MCM	32.1	32.6	36.5	1600	250	390
MVIC32ARUAYF001C350CA001P	1	350 MCM	34.5	35.1	39.0	1850	285	490
MVIC32ARUAYF001C500CA001P	1	500 MCM	37.6	38.1	42.0	2200	385	600
MVIC32ARUAYF001C600CA001P	1	600 MCM	40.2	40.7	44.5	2500	420	675
MVIC32ARUAYF001C750CA001P	1	750 MCM	42.6	43.1	47.0	2850	475	770
MVIC32ARUAYF001C01KCA001P	1	1000 MCM	46.1	46.6	52.0	3550	545	925

100% insulation

Product Code	No. of Cores	Core Cross sectional Area	Nominal Diameter			Weight (Approx.) Kg/Km	Current rating *	
			Under metallic screen	Over metallic screen	Overall		Directly buried in ground	In air
	No.	AWG / MCM	mm	mm	mm	Amps		
MVIC32ARUAYF001C002AA002P	1	2 AWG	22.5	23.0	27.0	850	110	165
MVIC32ARUAYF001C001AA002P	1	1 AWG	23.3	23.8	28.0	900	125	195
MVIC32ARUAYF001C1X0AA002P	1	1/0 AWG	24.2	24.7	29.0	1000	150	225
MVIC32ARUAYF001C2X0AA002P	1	2/0 AWG	25.3	25.8	30.0	1050	165	260
MVIC32ARUAYF001C3X0AA002P	1	3/0 AWG	26.5	27.0	31.0	1150	190	300
MVIC32ARUAYF001C4X0AA002P	1	4/0 AWG	27.8	28.3	32.5	1300	225	345
MVIC32ARUAYF001C250CA002P	1	250 MCM	29.1	29.6	33.5	1400	250	390
MVIC32ARUAYF001C350CA002P	1	350 MCM	31.5	32.0	36.0	1650	285	490
MVIC32ARUAYF001C500CA002P	1	500 MCM	34.5	35.0	39.0	1950	385	600
MVIC32ARUAYF001C600CA002P	1	600 MCM	36.5	37.1	42.5	2350	420	675
MVIC32ARUAYF001C750CA002P	1	750 MCM	39.0	39.5	45.0	2650	475	770
MVIC32ARUAYF001C01KCA002P	1	1000 MCM	42.5	43.0	48.5	3150	545	925

* Current Rating based on Table 310.16 (20°C Ambient Ground Temperature) and Table 310.17 (30°C Ambient Air Temperature) of National Electric Code



OUR CERTIFICATION
ISO 9001 | ISO 14001 | ISO 45001



OUR CERTIFICATION
ISO 9001 | ISO 14001 | ISO 45001



POLYCAB MV SC SCR ICEA S-93-639 25KV
MV Cable with Aluminium Conductor, EPR Insulation and Copper Screen

ELECTRICAL CHARACTERISTICS:

133% insulation:

No. of Cores	Core Cross sectional Area	Nom. DC Resistance at 25°C	Nom. AC Resistance at 90°C	Approx. Capacitance	Approx. Inductance	Approx. Reactance	Max. pulling tension on conductor	Charging Current per phase	Positive sequence impedance	Electric Stress at Conductor Screen	Short circuit rating	
											Phase conductor	Metallic screen
No.	AWG / MCM	Ω/km	Ω/km	μF/km	mH/km	Ω/km	kN	Amps/Km	Ohms/Km	kV/mm	kA/S	
1	2 AWG	0.531	0.666	0.15	0.50	0.19	1.7	1.39	1.12	5.8	3.0	3.3
1	1 AWG	0.423	0.528	0.16	0.48	0.18	2.1	1.48	0.89	5.6	3.8	3.4
1	1/0 AWG	0.335	0.420	0.17	0.47	0.18	2.7	1.57	0.72	5.3	4.8	3.5
1	2/0 AWG	0.266	0.331	0.18	0.44	0.17	3.4	1.68	0.57	5.1	6.0	3.6
1	3/0 AWG	0.211	0.266	0.19	0.42	0.16	4.3	1.81	0.46	4.9	7.6	3.8
1	4/0 AWG	0.167	0.210	0.21	0.41	0.15	5.4	1.94	0.38	4.7	9.6	3.9
1	250 MCM	0.141	0.177	0.22	0.40	0.15	6.4	2.07	0.33	4.5	11.3	4.1
1	350 MCM	0.101	0.128	0.25	0.38	0.14	8.9	2.32	0.25	4.3	15.9	4.4
1	500 MCM	0.071	0.092	0.28	0.35	0.13	12.8	2.62	0.20	4.1	22.6	4.8
1	600 MCM	0.059	0.076	0.31	0.35	0.13	15.3	2.88	0.18	3.8	27.2	5.1
1	750 MCM	0.047	0.066	0.33	0.34	0.13	19.2	3.11	0.16	3.7	34.0	5.4
1	1000 MCM	0.035	0.052	0.37	0.33	0.12	25.5	3.46	0.14	3.6	45.3	5.9

100% insulation:

No. of Cores	Core Cross sectional Area	Nom. DC Resistance at 25°C	Nom. AC Resistance at 90°C	Approx. Capacitance	Approx. Inductance	Approx. Reactance	Max. pulling tension on conductor	Charging Current per phase	Positive sequence impedance	Electric Stress at Conductor Screen	Short circuit rating	
											Phase conductor	Metallic screen
No.	AWG / MCM	Ω/km	Ω/km	μF/km	mH/km	Ω/km	kN	Amps/Km	Ohms/Km	kV/mm	kA/S	
1	2 AWG	0.531	0.666	0.17	0.48	0.18	1.7	1.58	1.11	6.5	3.0	2.9
1	1 AWG	0.423	0.528	0.18	0.46	0.17	2.1	1.68	0.89	6.2	3.8	3.0
1	1/0 AWG	0.335	0.420	0.19	0.45	0.17	2.7	1.80	0.71	6.0	4.8	3.1
1	2/0 AWG	0.266	0.331	0.21	0.42	0.16	3.4	1.94	0.57	5.7	6.0	3.2
1	3/0 AWG	0.211	0.266	0.22	0.41	0.15	4.3	2.08	0.46	5.5	7.6	3.4
1	4/0 AWG	0.167	0.210	0.24	0.39	0.15	5.4	2.25	0.38	5.3	9.6	3.6
1	250 MCM	0.141	0.177	0.26	0.38	0.14	6.4	2.41	0.33	5.1	11.3	3.7
1	350 MCM	0.101	0.128	0.29	0.36	0.14	8.9	2.70	0.25	4.9	15.9	4.0
1	500 MCM	0.071	0.092	0.33	0.34	0.13	12.8	3.07	0.20	4.7	22.6	4.4
1	600 MCM	0.059	0.076	0.35	0.34	0.13	15.3	3.32	0.18	4.5	27.2	4.7
1	750 MCM	0.047	0.066	0.38	0.33	0.12	19.2	3.61	0.16	4.4	34.0	5.0
1	1000 MCM	0.035	0.052	0.43	0.31	0.12	25.5	4.03	0.14	4.3	45.3	5.4

POLYCAB MV SC SCR ICEA S-93-639 35KV
MV Cable with Aluminium Conductor, EPR Insulation and Copper Screen

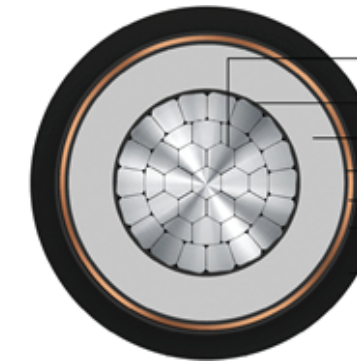

- Stranded Circular Compacted Aluminium Conductor
- Extruded Semi-Conducting Compound
- Extruded EPR Insulation
- Extruded Semi-Conducting Compound
- Helically Applied Copper Tape
- Wrapping Tape
- Extruded Polyvinyl Chloride Outer Sheath

Outstanding Features

- Flame retardant
- High life
- Sunlight resistant
- Oil, Acid and Alkalies resistant
- Corona resistant
- Treeing resistant
- Moisture resistant

Application

POLYCAB MV 35KV EPR insulated with Aluminium conductor single core cable is suitable to use in conduits, ducts, troughs, trays, direct burial in wet and dry conditions for power supply to wide networks.

Voltage Rating

Nominal Voltage: 35kV AC

Operation Temperature

Operating temperature: -35°C to +105°C
 Emergency operating temperature: 140°C
 Max. Short Circuit Temperature: 250°C

Construction

- Conductor: Circular Compacted Aluminium conductor as per ASTM B496
- Conductor Screen: Extruded Semi-conductive compound
- Insulation: Extruded EPR (TR-XLPE will be provided on demand)
- Insulation Screen: Extruded Semi-conductive compound
- Metallic Insulation Screen: Helically applied copper tape (Round wire / Corrugated copper screen will be provided on demand)
- Outer Sheath: Extruded Polyvinyl Chloride, Colour: Black (Alternative Sheath: CPE Outer Sheath or LSZH Outer sheath, and parameters will change accordingly)

Bending Radius: 12D

D is overall diameter of cable

Standard and References:

- ASTM B496
- ICEA S-93-639 (NEMA WC-74)
- UL 1072
- UL 1685 / FT-1
- IEEE 1202
- UL 2556

Voltage Rating (kV AC)	High Voltage Test (kV AC)	
	100% level	133% level
35	69	84

Compliance

- Conductor resistance ICEA S-93-639
- Insulation resistance ICEA S-93-639
- Vertical Tray Flame UL 1685
- Smoke Release UL 1685
- Flame Test IEEE 1202



OUR CERTIFICATION
 ISO 9001 | ISO 14001 | ISO 45001



OUR CERTIFICATION
 ISO 9001 | ISO 14001 | ISO 45001



DIMENSIONS, WEIGHT AND AMPACITY:

133% insulation:

Product Code	No. of Cores	Core Cross sectional Area	Nominal Diameter			Weight (Approx.)	Current rating *	
			Under metallic screen	Over metallic screen	Overall		Directly buried in ground	In air
	No.	AWG / MCM	mm	mm	mm	Kg/Km	Amps	
MVIC46ARUAYF001C1X0AA001P	1	1/0 AWG	32.4	32.9	37.0	1550	150	225
MVIC46ARUAYF001C2X0AA001P	1	2/0 AWG	33.4	33.9	38.0	1650	165	260
MVIC46ARUAYF001C3X0AA001P	1	3/0 AWG	34.6	35.1	39.0	1750	190	300
MVIC46ARUAYF001C4X0AA001P	1	4/0 AWG	35.9	36.4	40.5	1900	225	345
MVIC46ARUAYF001C250CA001P	1	250 MCM	37.2	37.7	42.0	2000	250	390
MVIC46ARUAYF001C350CA001P	1	350 MCM	39.6	40.1	44.0	2300	285	490
MVIC46ARUAYF001C500CA001P	1	500 MCM	42.7	43.2	48.5	2850	385	600
MVIC46ARUAYF001C600CA001P	1	600 MCM	45.2	45.7	51.5	3150	420	675
MVIC46ARUAYF001C750CA001P	1	750 MCM	47.6	48.1	53.5	3550	475	770
MVIC46ARUAYF001C01KCA001P	1	1000 MCM	51.2	51.7	57.5	4100	545	925

100% insulation:

Product Code	No. of Cores	Core Cross sectional Area	Nominal Diameter			Weight (Approx.)	Current rating *	
			Under metallic screen	Over metallic screen	Overall		Directly buried in ground	In air
	No.	AWG / MCM	mm	mm	mm	Kg/Km	Amps	
MVIC46ARUAYF001C1X0AA002P	1	1/0 AWG	28.5	29.1	33.0	1250	150	225
MVIC46ARUAYF001C2X0AA002P	1	2/0 AWG	29.6	30.1	34.0	1350	165	260
MVIC46ARUAYF001C3X0AA002P	1	3/0 AWG	30.8	31.3	35.5	1450	190	300
MVIC46ARUAYF001C4X0AA002P	1	4/0 AWG	32.1	32.6	36.5	1600	225	345
MVIC46ARUAYF001C250CA002P	1	250 MCM	33.4	33.9	38.0	1700	250	390
MVIC46ARUAYF001C350CA002P	1	350 MCM	35.8	36.3	40.5	1950	285	490
MVIC46ARUAYF001C500CA002P	1	500 MCM	38.8	39.4	43.5	2350	385	600
MVIC46ARUAYF001C600CA002P	1	600 MCM	40.9	41.4	47.0	2750	420	675
MVIC46ARUAYF001C750CA002P	1	750 MCM	43.3	43.8	49.5	3100	475	770
MVIC46ARUAYF001C01KCA002P	1	1000 MCM	46.8	47.3	53.0	3600	545	925

* Current Rating based on Table 310.16 (20°C Ambient Ground Temperature) and Table 310.17 (30°C Ambient Air Temperature) of National Electric Code

ELECTRICAL CHARACTERISTICS:

133% insulation:

No. of Cores	Core Cross sectional Area	Nom. DC Resistance at 25°C	Nom. AC Resistance at 90°C	Approx. Capacitance	Approx. Inductance	Approx. Reactance	Max. pulling tension on conductor	Charging Current per phase	Positive sequence impedance	Electric Stress at Conductor Screen	Short circuit rating	
											Phase conductor	Metallic screen
No.	AWG / MCM	Ω/km	Ω/km	μF/km	mH/km	Ω/km	kN	Amps/Km	Ohms/Km	kV/mm	kA/S	
1	1/0 AWG	0.335	0.420	0.14	0.49	0.19	2.7	1.84	0.72	6.4	4.8	4.1
1	2/0 AWG	0.266	0.331	0.15	0.47	0.18	3.4	1.96	0.58	6.1	6.0	4.3
1	3/0 AWG	0.211	0.266	0.16	0.45	0.17	4.3	2.10	0.47	5.8	7.6	4.4
1	4/0 AWG	0.167	0.210	0.17	0.43	0.16	5.4	2.24	0.38	5.5	9.6	4.6
1	250 MCM	0.141	0.177	0.18	0.42	0.16	6.4	2.41	0.34	5.3	11.3	4.7
1	350 MCM	0.101	0.128	0.20	0.40	0.15	8.9	2.68	0.26	5.0	15.9	5.0
1	500 MCM	0.071	0.092	0.23	0.38	0.15	12.8	3.01	0.21	4.7	22.6	5.4
1	600 MCM	0.059	0.076	0.25	0.38	0.14	15.3	3.28	0.19	4.5	27.2	5.7
1	750 MCM	0.047	0.066	0.27	0.36	0.14	19.2	3.54	0.17	4.4	34.0	6.1
1	1000 MCM	0.035	0.052	0.30	0.35	0.13	25.5	3.91	0.15	4.2	45.3	6.5

100% insulation:

No. of Cores	Core Cross sectional Area	Nom. DC Resistance at 25°C	Nom. AC Resistance at 90°C	Approx. Capacitance	Approx. Inductance	Approx. Reactance	Max. pulling tension on conductor	Charging Current per phase	Positive sequence impedance	Electric Stress at Conductor Screen	Short circuit rating	
											Phase conductor	Metallic screen
No.	AWG / MCM	Ω/km	Ω/km	μF/km	mH/km	Ω/km	kN	Amps/Km	Ohms/Km	kV/mm	kA/S	
1	1/0 AWG	0.335	0.420	0.16	0.47	0.18	2.7	2.10	0.72	7.1	4.8	3.7
1	2/0 AWG	0.266	0.331	0.17	0.45	0.17	3.4	2.25	0.58	6.8	6.0	3.8
1	3/0 AWG	0.211	0.266	0.18	0.43	0.16	4.3	2.41	0.46	6.5	7.6	3.9
1	4/0 AWG	0.167	0.210	0.20	0.42	0.16	5.4	2.58	0.38	6.2	9.6	4.1
1	250 MCM	0.141	0.177	0.21	0.41	0.15	6.4	2.75	0.33	6.0	11.3	4.3
1	350 MCM	0.101	0.128	0.23	0.38	0.14	8.9	3.07	0.26	5.7	15.9	4.6
1	500 MCM	0.071	0.092	0.26	0.36	0.14	12.8	3.47	0.20	5.4	22.6	4.9
1	600 MCM	0.059	0.076	0.28	0.36	0.14	15.3	3.73	0.18	5.2	27.2	5.2
1	750 MCM	0.047	0.066	0.31	0.35	0.13	19.2	4.04	0.16	5.1	34.0	5.5
1	1000 MCM	0.035	0.052	0.34	0.33	0.12	25.5	4.49	0.15	4.9	45.3	5.9



OUR CERTIFICATION
ISO 9001 | ISO 14001 | ISO 45001



OUR CERTIFICATION
ISO 9001 | ISO 14001 | ISO 45001



POLYCAB MV MC SCR ICEA S-93-639 5KV (or) 8KV
MV Cable with Copper Conductor, EPR Insulation and Copper Screen

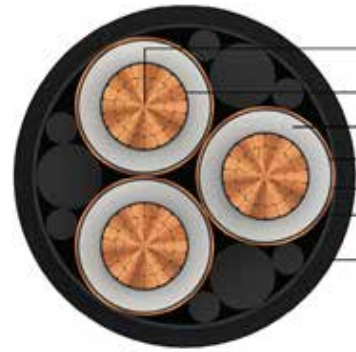

- Stranded Circular Compacted Copper Conductor
- Extruded Semi-Conducting Compound
- Extruded EPR Insulation
- Extruded Semi-Conducting Compound
- Helically applied Copper Tape
- Wrapping Tape
- Extruded Polyvinyl Chloride Outer Sheath

Outstanding Features

- Flame retardant
- High life
- Sunlight resistant
- Oil, Acid and Alkalies resistant
- Corona resistant
- Treeing resistant
- Moisture resistant

Application

POLYCAB MV 5 KV EPR insulated with Copper conductor Three core cable is suitable to use in conduits, ducts, troughs, trays, direct burial in wet and dry conditions for power supply to wide networks.

Voltage Rating

Nominal Voltage: 5kV AC (100% / 133%) or 8kV AC (100%)

Operation Temperature

Operating temperature: -35°C to +105°C
Emergency operating temperature: 140°C
Max. Short Circuit Temperature: 250°C

Construction

- Conductor: Circular Compacted Copper conductor as per ASTM B496
- Conductor Screen: Extruded Semi-conductive compound
- Insulation: Extruded EPR (TR-XLPE will be provided on demand)
- Insulation Screen: Extruded Semi-conductive compound
- Metallic Insulation Screen: Helically applied copper tape (Round / Corrugated copper screen will be provided on demand)
- Cores assembled together along with fillers (and ground wire optional)
- Binder: Wrapping tape (Armour will be provided on demand)
- Outer Sheath: Extruded Polyvinyl Chloride, Colour: Black (Alternative Sheath: CPE Outer Sheath or LSZH Outer sheath, and parameters will change accordingly)

Bending Radius: 7D

D is overall diameter of cable

Standard and References:

- ASTM B496
- ICEA S-93-639 (NEMA WC-74)
- UL 1072
- UL 1685 / FT-1
- IEEE 1202
- UL 2556

Voltage Rating (kV AC)	High Voltage Test (kV AC)	Min. Partial discharge test (kV AC)	
		100% level	133% level
5	18	4	5

Compliance

- Conductor resistance ICEA S-93-639
- Insulation resistance ICEA S-93-639
- Vertical Tray Flame UL 1685
- Smoke Release UL 1685
- Flame Test IEEE 1202



POLYCAB MV MC SCR ICEA S-93-639 5KV (or) 8KV
MV Cable with Copper Conductor, EPR Insulation and Copper Screen

DIMENSIONS, WEIGHT AND AMPACITY:

133% insulation (5kV) and 100% insulation (8kV):

Product Code	No. of Cores	Core Cross sectional Area	Nominal Diameter			Weight (Approx.) Kg/Km	Current rating *	
			Under metallic screen	Over metallic screen	Overall		Directly buried in ground	In air
	No.	AWG / MCM	mm	mm	mm	Amps		
MVIC36CRUAYF003C002AA001P	3	2 AWG	15.1	15.6	37.5	2250	130	155
MVIC36CRUAYF003C001AA001P	3	1 AWG	15.9	16.4	39.5	2550	150	175
MVIC36CRUAYF003C1X0AA001P	3	1/0 AWG	16.9	17.4	41.5	2950	170	205
MVIC36CRUAYF003C2X0AA001P	3	2/0 AWG	17.9	18.4	44.0	3500	200	240
MVIC36CRUAYF003C3X0AA001P	3	3/0 AWG	19.1	19.6	48.0	4250	225	280
MVIC36CRUAYF003C4X0AA001P	3	4/0 AWG	20.4	20.9	51.0	5000	265	320
MVIC36CRUAYF003C250CA001P	3	250 MCM	21.7	22.2	53.5	5650	290	360
MVIC36CRUAYF003C350CA001P	3	350 MCM	24.1	24.6	59.0	7350	355	450
MVIC36CRUAYF003C500CA001P	3	500 MCM	27.2	27.7	65.5	9750	435	550
MVIC36CRUAYF003C600CA001P	3	600 MCM	29.7	30.2	72.0	11750	480	615
MVIC36CRUAYF003C750CA001P	3	750 MCM	32.1	32.7	77.5	14100	540	695
MVIC36CRUAYF003C01KCA001P	3	1000 MCM	35.7	36.2	85.0	17900	620	830

100% insulation (5kV):

Product Code	No. of Cores	Core Cross sectional Area	Nominal Diameter			Weight (Approx.) Kg/Km	Current rating *	
			Under metallic screen	Over metallic screen	Overall		Directly buried in ground	In air
	No.	AWG / MCM	mm	mm	mm	Amps		
MVIC36CRUAYF003C002AA002P	3	2 AWG	13.8	14.3	35.0	2100	130	155
MVIC36CRUAYF003C001AA002P	3	1 AWG	14.7	15.2	37.0	2400	150	175
MVIC36CRUAYF003C1X0AA002P	3	1/0 AWG	15.6	16.1	39.0	2750	170	205
MVIC36CRUAYF003C2X0AA002P	3	2/0 AWG	16.6	17.2	41.0	3300	200	240
MVIC36CRUAYF003C3X0AA002P	3	3/0 AWG	17.8	18.3	43.5	3900	225	280
MVIC36CRUAYF003C4X0AA002P	3	4/0 AWG	19.2	19.7	48.0	4800	265	320
MVIC36CRUAYF003C250CA002P	3	250 MCM	20.4	20.9	51.0	5450	290	360
MVIC36CRUAYF003C350CA002P	3	350 MCM	22.9	23.4	56.0	7100	355	450
MVIC36CRUAYF003C500CA002P	3	500 MCM	25.9	26.4	62.5	9500	435	550
MVIC36CRUAYF003C600CA002P	3	600 MCM	27.9	28.4	67.0	11150	480	615
MVIC36CRUAYF003C750CA002P	3	750 MCM	30.3	30.8	73.5	13650	540	695
MVIC36CRUAYF003C01KCA002P	3	1000 MCM	33.8	34.3	81.0	17450	620	830

* Current Rating based on Table 310.16 (20°C Ambient Ground Temperature) and Table 310.17 (30°C Ambient Air Temperature) of National Electric Code



POLYCAB MV MC SCR ICEA S-93-639 5KV (or) 8KV
MV Cable with Copper Conductor, EPR Insulation and Copper Screen

ELECTRICAL CHARACTERISTICS:

133% insulation:

No. of Cores	Core Cross sectional Area	Nom. DC Resistance at 25°C	Nom. AC Resistance at 90°C	Approx. Capacitance	Approx. Inductance	Approx. Reactance	Max. pulling tension on conductor	Charging Current per phase	Positive sequence impedance	Electric Stress at Conductor Screen	Short circuit rating	
											Phase conductor	Metallic screen
No.	AWG / MCM	Ω/km	Ω/km	μF/km	mH/km	Ω/km	kN	Amps/Km	Ohms/Km	kV/mm	kA/S	
1	2 AWG	0.531	0.666	0.30	0.37	0.14	2.4	0.56	0.68	2.1	4.8	2.0
1	1 AWG	0.423	0.528	0.32	0.36	0.13	3.0	0.60	0.55	2.1	6.1	2.1
1	1/0 AWG	0.335	0.420	0.35	0.34	0.13	3.7	0.66	0.44	2.0	7.7	2.2
1	2/0 AWG	0.266	0.331	0.38	0.32	0.12	4.7	0.71	0.36	1.9	9.7	2.3
1	3/0 AWG	0.211	0.266	0.41	0.31	0.12	6.0	0.78	0.29	1.9	12.2	2.5
1	4/0 AWG	0.167	0.210	0.45	0.30	0.11	7.5	0.85	0.24	1.9	15.3	2.6
1	250 MCM	0.141	0.177	0.49	0.30	0.11	8.9	0.92	0.21	1.8	18.1	2.8
1	350 MCM	0.101	0.128	0.56	0.28	0.11	12.4	1.05	0.17	1.7	25.4	3.1
1	500 MCM	0.071	0.092	0.64	0.27	0.10	17.7	1.21	0.14	1.7	36.2	3.5
1	600 MCM	0.059	0.076	0.72	0.27	0.10	21.3	1.35	0.13	1.5	43.5	3.8
1	750 MCM	0.047	0.066	0.79	0.26	0.10	26.6	1.48	0.12	1.5	54.4	4.1
1	1000 MCM	0.035	0.052	0.89	0.25	0.10	35.4	1.67	0.11	1.5	72.5	4.5

100% insulation:

No. of Cores	Core Cross sectional Area	Nom. DC Resistance at 25°C	Nom. AC Resistance at 90°C	Approx. Capacitance	Approx. Inductance	Approx. Reactance	Max. pulling tension on conductor	Charging Current per phase	Positive sequence impedance	Electric Stress at Conductor Screen	Short circuit rating	
											Phase conductor	Metallic screen
No.	AWG / MCM	Ω/km	Ω/km	μF/km	mH/km	Ω/km	kN	Amps/Km	Ohms/Km	kV/mm	kA/S	
1	2 AWG	0.531	0.666	0.36	0.35	0.13	2.4	0.68	1.10	2.5	4.8	1.8
1	1 AWG	0.423	0.528	0.39	0.34	0.13	3.0	0.73	0.88	2.4	6.1	1.9
1	1/0 AWG	0.335	0.420	0.42	0.33	0.12	3.7	0.80	0.70	2.4	7.7	2.0
1	2/0 AWG	0.266	0.331	0.46	0.31	0.12	4.7	0.87	0.56	2.3	9.7	2.2
1	3/0 AWG	0.211	0.266	0.51	0.30	0.11	6.0	0.95	0.45	2.2	12.2	2.3
1	4/0 AWG	0.167	0.210	0.56	0.29	0.11	7.5	1.05	0.36	2.2	15.3	2.5
1	250 MCM	0.141	0.177	0.60	0.29	0.11	8.9	1.14	0.31	2.1	18.1	2.6
1	350 MCM	0.101	0.128	0.69	0.27	0.10	12.4	1.30	0.23	2.0	25.4	2.9
1	500 MCM	0.071	0.092	0.80	0.26	0.10	17.7	1.51	0.18	2.0	36.2	3.3
1	600 MCM	0.059	0.076	0.88	0.26	0.10	21.3	1.65	0.16	1.9	43.5	3.6
1	750 MCM	0.047	0.066	0.96	0.25	0.09	26.6	1.82	0.14	1.9	54.4	3.9
1	1000 MCM	0.035	0.052	1.09	0.24	0.09	35.4	2.06	0.12	1.9	72.5	4.3



OUR CERTIFICATION
ISO 9001 | ISO 14001 | ISO 45001



POLYCAB MV MC SCR ICEA S-93-639 8KV
MV Cable with Copper Conductor, EPR Insulation and Copper Screen

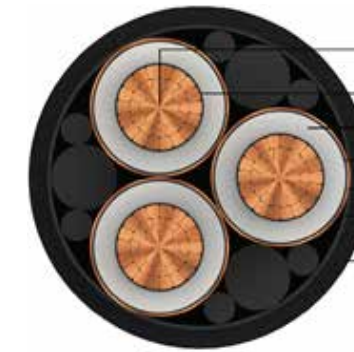

- Stranded Circular Compacted Copper Conductor
- Extruded Semi-Conducting Compound
- Extruded EPR Insulation
- Extruded Semi-Conducting Compound
- Helically applied Copper Tape
- Wrapping Tape
- Extruded Polyvinyl Chloride Outer Sheath

Outstanding Features

- Flame retardant
- High life
- Sunlight resistant
- Oil, Acid and Alkalies resistant
- Corona resistant
- Treeing resistant
- Moisture resistant

Application

POLYCAB MV 8KV EPR insulated with Copper conductor Three core cable is suitable to use in conduits, ducts, troughs, trays, direct burial in wet and dry conditions for power supply to wide networks.

Voltage Rating

Nominal Voltage: 8kV AC

Operation Temperature

Operating temperature: -35°C to +105°C
Emergency operating temperature: 140°C
Max. Short Circuit Temperature: 250°C

Construction

- Conductor: Circular Compacted Copper conductor as per ASTM B496
- Conductor Screen: Extruded Semi-conductive compound
- Insulation: Extruded EPR (TR-XLPE will be provided on demand)
- Insulation Screen: Extruded Semi-conductive compound
- Metallic Insulation Screen: Helically applied copper tape (*Round / Corrugated copper screen will be provided on demand*)
- Cores assembled together along with fillers (and ground wire optional)
- Binder: Wrapping tape
- (Armour will be provided on demand)
- Outer Sheath: Extruded Polyvinyl Chloride, Colour: Black (*Alternative Sheath: CPE Outer Sheath or LSZH Outer sheath, and parameters will change accordingly*)

Bending Radius: 7D

D is overall diameter of cable

Standard and References:

- ASTM B496
- ICEA S-93-639 (NEMA WC-74)
- UL 1072
- UL 1685 / FT-1
- IEEE 1202
- UL 2556

Voltage Rating (kV AC)	High Voltage Test (kV AC)		Min. Partial discharge test (kV AC)	
	100% level	133% level	100% level	133% level
8	23	28	6	8

Compliance

- Conductor resistance ICEA S-93-639
- Insulation resistance ICEA S-93-639
- Vertical Tray Flame UL 1685
- Smoke Release UL 1685
- Flame Test IEEE 1202



OUR CERTIFICATION
ISO 9001 | ISO 14001 | ISO 45001



POLYCAB MV MC SCR ICEA S-93-639 8KV
MV Cable with Copper Conductor, EPR Insulation and Copper Screen

DIMENSIONS, WEIGHT AND AMPACITY:

133% insulation:

Product Code	No. of Cores	Core Cross sectional Area	Nominal Diameter			Weight (Approx.) Kg/Km	Current rating *	
			Under metallic screen	Over metallic screen	Overall		Directly buried in ground	In air
	No.	AWG / MCM	mm	mm	mm	Amps		
MVIC48CRUAYF003C002AA001P	3	2 AWG	16.4	16.9	40.5	2400	130	155
MVIC48CRUAYF003C001AA001P	3	1 AWG	17.2	17.7	42.5	2750	150	175
MVIC48CRUAYF003C1X0AA001P	3	1/0 AWG	18.1	18.6	46.0	3300	170	205
MVIC48CRUAYF003C2X0AA001P	3	2/0 AWG	19.2	19.7	48.0	3850	200	240
MVIC48CRUAYF003C3X0AA001P	3	3/0 AWG	20.4	20.9	50.5	4450	225	280
MVIC48CRUAYF003C4X0AA001P	3	4/0 AWG	21.7	22.2	53.5	5200	265	320
MVIC48CRUAYF003C250CA001P	3	250 MCM	23.0	23.5	56.5	5900	290	360
MVIC48CRUAYF003C350CA001P	3	350 MCM	25.4	25.9	61.5	7600	355	450
MVIC48CRUAYF003C500CA001P	3	500 MCM	28.4	28.9	68.0	10050	435	550
MVIC48CRUAYF003C600CA001P	3	600 MCM	31.0	31.5	75.0	12050	480	615
MVIC48CRUAYF003C750CA001P	3	750 MCM	33.4	33.9	80.0	14400	540	695
MVIC48CRUAYF003C01KCA001P	3	1000 MCM	36.9	37.4	87.5	18250	620	830

100% insulation:

Product Code	No. of Cores	Core Cross sectional Area	Nominal Diameter			Weight (Approx.) Kg/Km	Current rating *	
			Under metallic screen	Over metallic screen	Overall		Directly buried in ground	In air
	No.	AWG / MCM	mm	mm	mm	Amps		
MVIC48CRUAYF003C002AA002P	3	2 AWG	15.1	15.6	37.5	2250	130	155
MVIC48CRUAYF003C001AA002P	3	1 AWG	15.9	16.4	39.5	2550	150	175
MVIC48CRUAYF003C1X0AA002P	3	1/0 AWG	16.9	17.4	41.5	2950	170	205
MVIC48CRUAYF003C2X0AA002P	3	2/0 AWG	17.9	18.4	44.0	3500	200	240
MVIC48CRUAYF003C3X0AA002P	3	3/0 AWG	19.1	19.6	48.0	4250	225	280
MVIC48CRUAYF003C4X0AA002P	3	4/0 AWG	20.4	20.9	51.0	5000	265	320
MVIC48CRUAYF003C250CA002P	3	250 MCM	21.7	22.2	53.5	5650	290	360
MVIC48CRUAYF003C350CA002P	3	350 MCM	24.1	24.6	59.0	7350	355	450
MVIC48CRUAYF003C500CA002P	3	500 MCM	27.2	27.7	65.5	9750	435	550
MVIC48CRUAYF003C600CA002P	3	600 MCM	29.7	30.2	72.0	11750	480	615
MVIC48CRUAYF003C750CA002P	3	750 MCM	32.1	32.7	77.5	14100	540	695
MVIC48CRUAYF003C01KCA002P	3	1000 MCM	35.7	36.2	85.0	17900	620	830

* Current Rating based on Table 310.16 (20°C Ambient Ground Temperature) and Table 310.17 (30°C Ambient Air Temperature) of National Electric Code



POLYCAB MV MC SCR ICEA S-93-639 8KV
MV Cable with Copper Conductor, EPR Insulation and Copper Screen

ELECTRICAL CHARACTERISTICS:

133% insulation:

No. of Cores	Core Cross sectional Area	Nom. DC Resistance at 25°C	Nom. AC Resistance at 90°C	Approx. Capacitance	Approx. Inductance	Approx. Reactance	Max. pulling tension on conductor	Charging Current per phase	Positive sequence impedance	Electric Stress at Conductor Screen	Short circuit rating	
											Phase conductor	Metallic screen
No.	AWG / MCM	Ω/km	Ω/km	μF/km	mH/km	Ω/km	kN	Amps/Km	Ohms/Km	kV/mm	kA/S	
1	2 AWG	0.531	0.666	0.26	0.38	0.15	2.4	0.77	0.68	3.0	4.8	2.1
1	1 AWG	0.423	0.528	0.28	0.37	0.14	3.0	0.83	0.55	2.9	6.1	2.2
1	1/0 AWG	0.335	0.420	0.30	0.36	0.14	3.7	0.90	0.44	2.8	7.7	2.3
1	2/0 AWG	0.266	0.331	0.32	0.34	0.13	4.7	0.98	0.36	2.7	9.7	2.5
1	3/0 AWG	0.211	0.266	0.35	0.33	0.12	6.0	1.06	0.29	2.7	12.2	2.6
1	4/0 AWG	0.167	0.210	0.38	0.32	0.12	7.5	1.16	0.24	2.6	15.3	2.8
1	250 MCM	0.141	0.177	0.41	0.31	0.12	8.9	1.25	0.21	2.5	18.1	3.0
1	350 MCM	0.101	0.128	0.47	0.29	0.11	12.4	1.42	0.17	2.4	25.4	3.3
1	500 MCM	0.071	0.092	0.54	0.28	0.11	17.7	1.64	0.14	2.3	36.2	3.6
1	600 MCM	0.059	0.076	0.60	0.28	0.10	21.3	1.82	0.13	2.1	43.5	4.0
1	750 MCM	0.047	0.066	0.66	0.27	0.10	26.6	1.99	0.12	2.1	54.4	4.3
1	1000 MCM	0.035	0.052	0.74	0.26	0.10	35.4	2.24	0.11	2.1	72.5	4.7

100% insulation:

No. of Cores	Core Cross sectional Area	Nom. DC Resistance at 25°C	Nom. AC Resistance at 90°C	Approx. Capacitance	Approx. Inductance	Approx. Reactance	Max. pulling tension on conductor	Charging Current per phase	Positive sequence impedance	Electric Stress at Conductor Screen	Short circuit rating	
											Phase conductor	Metallic screen
No.	AWG / MCM	Ω/km	Ω/km	μF/km	mH/km	Ω/km	kN	Amps/Km	Ohms/Km	kV/mm	kA/S	
1	2 AWG	0.531	0.666	0.30	0.37	0.14	2.4	0.56	0.68	2.1	4.8	2.0
1	1 AWG	0.423	0.528	0.32	0.36	0.13	3.0	0.60	0.55	2.1	6.1	2.1
1	1/0 AWG	0.335	0.420	0.35	0.34	0.13	3.7	0.66	0.44	2.0	7.7	2.2
1	2/0 AWG	0.266	0.331	0.38	0.32	0.12	4.7	0.71	0.36	1.9	9.7	2.3
1	3/0 AWG	0.211	0.266	0.41	0.31	0.12	6.0	0.78	0.29	1.9	12.2	2.5
1	4/0 AWG	0.167	0.210	0.45	0.30	0.11	7.5	0.85	0.24	1.9	15.3	2.6
1	250 MCM	0.141	0.177	0.49	0.30	0.11	8.9	0.92	0.21	1.8	18.1	2.8
1	350 MCM	0.101	0.128	0.56	0.28	0.11	12.4	1.05	0.17	1.7	25.4	3.1
1	500 MCM	0.071	0.092	0.64	0.27	0.10	17.7	1.21	0.14	1.7	36.2	3.5
1	600 MCM	0.059	0.076	0.72	0.27	0.10	21.3	1.35	0.13	1.5	43.5	3.8
1	750 MCM	0.047	0.066	0.79	0.26	0.10	26.6	1.48	0.12	1.5	54.4	4.1
1	1000 MCM	0.035	0.052	0.89	0.25	0.10	35.4	1.67	0.11	1.5	72.5	4.5



POLYCAB MV MC SCR ICEA S-93-639 15KV
MV Cable with Copper Conductor, EPR Insulation and Copper Screen

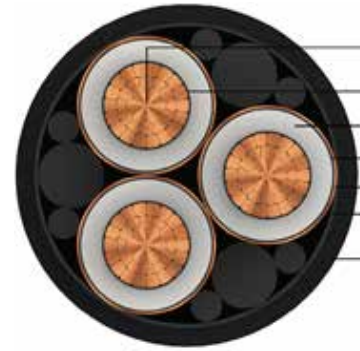

- Stranded Circular Compacted Copper Conductor
- Extruded Semi-Conducting Compound
- Extruded EPR Insulation
- Extruded Semi-Conducting Compound
- Helically applied Copper Tape
- Wrapping Tape
- Extruded Polyvinyl Chloride Outer Sheath

Outstanding Features

- Flame retardant
- High life
- Sunlight resistant
- Oil, Acid and Alkalies resistant
- Corona resistant
- Treeing resistant
- Moisture resistant

Application

POLYCAB MV 15KV EPR insulated with Copper conductor Three core cable is suitable to use in conduits, ducts, troughs, trays, direct burial in wet and dry conditions for power supply to wide networks.

Voltage Rating

Nominal Voltage: 15kV AC

Operation Temperature

Operating temperature: -35°C to +105°C
Emergency operating temperature: 140°C
Max. Short Circuit Temperature: 250°C

Construction

- Conductor: Circular Compacted Copper conductor as per ASTM B496
- Conductor Screen: Extruded Semi-conductive compound
- Insulation: Extruded EPR (TR-XLPE will be provided on demand)
- Insulation Screen: Extruded Semi-conductive compound
- Metallic Insulation Screen: Helically applied copper tape (Round / Corrugated copper screen will be provided on demand)
- Cores assembled together along with fillers (and ground wire optional)
- Binder: Wrapping tape (Armour will be provided on demand)
- Outer Sheath: Extruded Polyvinyl Chloride, Colour: Black (Alternative Sheath: CPE Outer Sheath or LSZH Outer sheath, and parameters will change accordingly)

Bending Radius: 7D

D is overall diameter of cable

Standard and References:

- ASTM B496
- ICEA S-93-639 (NEMA WC-74)
- UL 1072
- UL 1685 / FT-1
- IEEE 1202
- UL 2556

Voltage Rating (kV AC)	High Voltage Test (kV AC)		Min. Partial discharge test (kV AC)	
	100% level	133% level	100% level	133% level
15	35	44	11	15

Compliance

- Conductor resistance ICEA S-93-639
- Insulation resistance ICEA S-93-639
- Vertical Tray Flame UL 1685
- Smoke Release UL 1685
- Flame Test IEEE 1202



POLYCAB MV MC SCR ICEA S-93-639 15KV
MV Cable with Copper Conductor, EPR Insulation and Copper Screen

DIMENSIONS, WEIGHT AND AMPACITY:

133% insulation:

Product Code	No. of Cores	Core Cross sectional Area	Nominal Diameter			Weight (Approx.) Kg/Km	Current rating *	
			Under metallic screen	Over metallic screen	Overall		Directly buried in ground	In air
	No.	AWG / MCM	mm	mm	mm	Amps		
MVIC37CRUAYF003C002AA001P	3	2 AWG	20.4	20.9	51.0	3200	130	155
MVIC37CRUAYF003C001AA001P	3	1 AWG	21.3	21.8	52.5	3550	150	175
MVIC37CRUAYF003C1X0AA001P	3	1/0 AWG	22.2	22.7	54.5	4000	170	205
MVIC37CRUAYF003C2X0AA001P	3	2/0 AWG	23.3	23.8	57.0	4600	200	240
MVIC37CRUAYF003C3X0AA001P	3	3/0 AWG	24.4	24.9	59.5	5200	225	280
MVIC37CRUAYF003C4X0AA001P	3	4/0 AWG	25.8	26.3	62.5	6000	265	320
MVIC37CRUAYF003C250CA001P	3	250 MCM	27.0	27.6	65.0	6700	290	360
MVIC37CRUAYF003C350CA001P	3	350 MCM	29.5	30.0	70.5	8450	355	450
MVIC37CRUAYF003C500CA001P	3	500 MCM	32.5	33.0	78.0	11200	435	550
MVIC37CRUAYF003C600CA001P	3	600 MCM	35.1	35.6	83.5	13100	480	615
MVIC37CRUAYF003C750CA001P	3	750 MCM	37.5	38.0	89.0	15500	540	695
MVIC37CRUAYF003C01KCA001P	3	1000 MCM	41.0	41.5	96.5	19450	620	830

100% insulation:

Product Code	No. of Cores	Core Cross sectional Area	Nominal Diameter			Weight (Approx.) Kg/Km	Current rating *	
			Under metallic screen	Over metallic screen	Overall		Directly buried in ground	In air
	No.	AWG / MCM	mm	mm	mm	Amps		
MVIC37CRUAYF003C002AA002P	3	2 AWG	18.1	18.7	46.0	2850	130	155
MVIC37CRUAYF003C001AA002P	3	1 AWG	19.0	19.5	47.5	3200	150	175
MVIC37CRUAYF003C1X0AA002P	3	1/0 AWG	19.9	20.4	49.5	3600	170	205
MVIC37CRUAYF003C2X0AA002P	3	2/0 AWG	21.0	21.5	52.0	4150	200	240
MVIC37CRUAYF003C3X0AA002P	3	3/0 AWG	22.2	22.7	54.5	4800	225	280
MVIC37CRUAYF003C4X0AA002P	3	4/0 AWG	23.5	24.0	57.5	5550	265	320
MVIC37CRUAYF003C250CA002P	3	250 MCM	24.8	25.3	60.0	6250	290	360
MVIC37CRUAYF003C350CA002P	3	350 MCM	27.2	27.7	65.5	7950	355	450
MVIC37CRUAYF003C500CA002P	3	500 MCM	30.2	30.7	73.0	10650	435	550
MVIC37CRUAYF003C600CA002P	3	600 MCM	32.2	32.7	77.5	12350	480	615
MVIC37CRUAYF003C750CA002P	3	750 MCM	34.6	35.1	82.5	14750	540	695
MVIC37CRUAYF003C01KCA002P	3	1000 MCM	38.2	38.7	90.5	18600	620	830

* Current Rating based on Table 310.16 (20°C Ambient Ground Temperature) and Table 310.17 (30°C Ambient Air Temperature) of National Electric Code



POLYCAB MV MC SCR ICEA S-93-639 15KV
MV Cable with Copper Conductor, EPR Insulation and Copper Screen

ELECTRICAL CHARACTERISTICS:

133% insulation:

No. of Cores	Core Cross sectional Area	Nom. DC Resistance at 25°C	Nom. AC Resistance at 90°C	Approx. Capacitance	Approx. Inductance	Approx. Reactance	Max. pulling tension on conductor	Charging Current per phase	Positive sequence impedance	Electric Stress at Conductor Screen	Short circuit rating	
No.	AWG / MCM	Ω/km	Ω/km	μF/km	mH/km	Ω/km	kN	Amps/Km	Ohms/Km	kV/mm	Phase conductor	Metallic screen
											kA/S	
1	2 AWG	0.531	0.666	0.19	0.43	0.16	2.4	1.05	0.69	4.3	4.8	2.6
1	1 AWG	0.423	0.528	0.20	0.41	0.16	3.0	1.13	0.55	4.1	6.1	2.7
1	1/0 AWG	0.335	0.420	0.21	0.40	0.15	3.7	1.21	0.45	4.0	7.7	2.9
1	2/0 AWG	0.266	0.331	0.23	0.38	0.14	4.7	1.30	0.36	3.8	9.7	3.0
1	3/0 AWG	0.211	0.266	0.25	0.36	0.14	6.0	1.41	0.30	3.7	12.2	3.1
1	4/0 AWG	0.167	0.210	0.27	0.35	0.13	7.5	1.52	0.25	3.6	15.3	3.3
1	250 MCM	0.141	0.177	0.29	0.34	0.13	8.9	1.64	0.22	3.4	18.1	3.5
1	350 MCM	0.101	0.128	0.33	0.32	0.12	12.4	1.84	0.18	3.3	25.4	3.8
1	500 MCM	0.071	0.092	0.37	0.31	0.12	17.7	2.11	0.15	3.2	36.2	4.1
1	600 MCM	0.059	0.076	0.41	0.30	0.11	21.3	2.33	0.14	3.0	43.5	4.5
1	750 MCM	0.047	0.066	0.45	0.29	0.11	26.6	2.53	0.13	2.9	54.4	4.8
1	1000 MCM	0.035	0.052	0.50	0.28	0.11	35.4	2.83	0.12	2.8	72.5	5.2

100% insulation:

No. of Cores	Core Cross sectional Area	Nom. DC Resistance at 25°C	Nom. AC Resistance at 90°C	Approx. Capacitance	Approx. Inductance	Approx. Reactance	Max. pulling tension on conductor	Charging Current per phase	Positive sequence impedance	Electric Stress at Conductor Screen	Short circuit rating	
No.	AWG / MCM	Ω/km	Ω/km	μF/km	mH/km	Ω/km	kN	Amps/Km	Ohms/Km	kV/mm	Phase conductor	Metallic screen
											kA/S	
1	2 AWG	0.531	0.666	0.22	0.40	0.15	2.4	1.23	1.11	4.9	4.8	2.3
1	1 AWG	0.423	0.528	0.23	0.39	0.15	3.0	1.32	0.88	4.8	6.1	2.5
1	1/0 AWG	0.335	0.420	0.25	0.38	0.14	3.7	1.43	0.71	4.6	7.7	2.6
1	2/0 AWG	0.266	0.331	0.27	0.35	0.13	4.7	1.54	0.56	4.4	9.7	2.7
1	3/0 AWG	0.211	0.266	0.30	0.34	0.13	6.0	1.67	0.45	4.3	12.2	2.9
1	4/0 AWG	0.167	0.210	0.32	0.33	0.12	7.5	1.81	0.37	4.2	15.3	3.0
1	250 MCM	0.141	0.177	0.35	0.32	0.12	8.9	1.95	0.32	4.0	18.1	3.2
1	350 MCM	0.101	0.128	0.39	0.31	0.12	12.4	2.22	0.24	3.9	25.4	3.5
1	500 MCM	0.071	0.092	0.45	0.29	0.11	17.7	2.54	0.18	3.7	36.2	3.9
1	600 MCM	0.059	0.076	0.49	0.29	0.11	21.3	2.76	0.16	3.6	43.5	4.1
1	750 MCM	0.047	0.066	0.53	0.28	0.10	26.6	3.01	0.14	3.5	54.4	4.4
1	1000 MCM	0.035	0.052	0.60	0.27	0.10	35.4	3.39	0.13	3.5	72.5	4.9



OUR CERTIFICATION
 ISO 9001 | ISO 14001 | ISO 45001



POLYCAB MV MC SCR ICEA S-93-639 25KV
MV Cable with Copper Conductor, EPR Insulation and Copper Screen

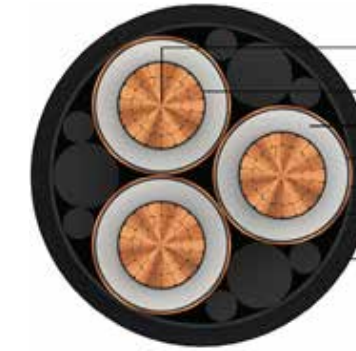

- Stranded Circular Compacted Copper Conductor
- Extruded Semi-Conducting Compound
- Extruded EPR Insulation
- Extruded Semi-Conducting Compound
- Helically applied Copper Tape
- Wrapping Tape
- Extruded Polyvinyl Chloride Outer Sheath

Outstanding Features

- Flame retardant
- High life
- Sunlight resistant
- Oil, Acid and Alkalies resistant
- Corona resistant
- Treeing resistant
- Moisture resistant

Application

POLYCAB MV 25KV EPR insulated with Copper conductor Three core cable is suitable to use in conduits, ducts, troughs, trays, direct burial in wet and dry conditions for power supply to wide networks.

Voltage Rating

Nominal Voltage: 25kV AC

Operation Temperature

Operating temperature: -35°C to +105°C
 Emergency operating temperature: 140°C
 Max. Short Circuit Temperature: 250°C

Construction

- Conductor: Circular Compacted Copper conductor as per ASTM B496
- Conductor Screen: Extruded Semi-conductive compound
- Insulation: Extruded EPR (TR-XLPE will be provided on demand)
- Insulation Screen: Extruded Semi-conductive compound
- Metallic Insulation Screen: Helically applied copper tape (*Round / Corrugated copper screen will be provided on demand*)
- Cores assembled together along with fillers (and ground wire optional)
- Binder: Wrapping tape (*Armour will be provided on demand*)
- Outer Sheath: Extruded Polyvinyl Chloride, Colour: Black (*Alternative Sheath: CPE Outer Sheath or LSZH Outer sheath, and parameters will change accordingly*)

Bending Radius: 7D

D is overall diameter of cable

Standard and References:

- ASTM B496
- ICEA S-93-639 (NEMA WC-74)
- UL 1072
- UL 1685 / FT-1
- IEEE 1202
- UL 2556

Voltage Rating (kV AC)	High Voltage Test (kV AC)		Min. Partial discharge test (kV AC)	
	100% level	133% level	100% level	133% level
8	23	28	6	8

Compliance

- Conductor resistance ICEA S-93-639
- Insulation resistance ICEA S-93-639
- Vertical Tray Flame UL 1685
- Smoke Release UL 1685
- Flame Test IEEE 1202



OUR CERTIFICATION
 ISO 9001 | ISO 14001 | ISO 45001



POLYCAB MV MC SCR ICEA S-93-639 25KV
MV Cable with Copper Conductor, EPR Insulation and Copper Screen

DIMENSIONS, WEIGHT AND AMPACITY:

133% insulation:

Product Code	No. of Cores	Core Cross sectional Area	Nominal Diameter			Weight (Approx.) Kg/Km	Current rating *	
			Under metallic screen	Over metallic screen	Overall		Directly buried in ground	In air
	No.	AWG / MCM	mm	mm	mm	Amps		
MVIC32CRUAYF001C002AA001P	3	2 AWG	25.5	26.0	62.0	4150	130	155
MVIC32CRUAYF001C001AA001P	3	1 AWG	26.3	26.9	63.5	4550	150	175
MVIC32CRUAYF001C1X0AA001P	3	1/0 AWG	27.3	27.8	65.5	5000	170	205
MVIC32CRUAYF001C2X0AA001P	3	2/0 AWG	28.3	28.8	68.0	5600	200	240
MVIC32CRUAYF001C3X0AA001P	3	3/0 AWG	29.5	30.0	70.5	6300	225	280
MVIC32CRUAYF001C4X0AA001P	3	4/0 AWG	30.8	31.3	74.5	7300	265	320
MVIC32CRUAYF001C250CA001P	3	250 MCM	32.1	32.6	77.5	8050	290	360
MVIC32CRUAYF001C350CA001P	3	350 MCM	34.5	35.1	82.5	9900	355	450
MVIC32CRUAYF001C500CA001P	3	500 MCM	37.6	38.1	89.0	12550	435	550
MVIC32CRUAYF001C600CA001P	3	600 MCM	40.2	40.7	94.5	14500	480	615
MVIC32CRUAYF001C750CA001P	3	750 MCM	42.6	43.1	100.0	17000	540	695
MVIC32CRUAYF001C01KCA001P	3	1000 MCM	46.1	46.6	107.5	21050	620	830

100% insulation (5kV):

Product Code	No. of Cores	Core Cross sectional Area	Nominal Diameter			Weight (Approx.) Kg/Km	Current rating *	
			Under metallic screen	Over metallic screen	Overall		Directly buried in ground	In air
	No.	AWG / MCM	mm	mm	mm	Amps		
MVIC32CRUAYF001C002AA002P	3	2 AWG	22.5	23.0	55.0	3600	130	155
MVIC32CRUAYF001C001AA002P	3	1 AWG	23.3	23.8	57.0	3950	150	175
MVIC32CRUAYF001C1X0AA002P	3	1/0 AWG	24.2	24.7	59.0	4350	170	205
MVIC32CRUAYF001C2X0AA002P	3	2/0 AWG	25.3	25.8	61.5	4950	200	240
MVIC32CRUAYF001C3X0AA002P	3	3/0 AWG	26.5	27.0	64.0	5600	225	280
MVIC32CRUAYF001C4X0AA002P	3	4/0 AWG	27.8	28.3	66.5	6400	265	320
MVIC32CRUAYF001C250CA002P	3	250 MCM	29.1	29.6	69.5	7150	290	360
MVIC32CRUAYF001C350CA002P	3	350 MCM	31.5	32.0	76.0	9150	355	450
MVIC32CRUAYF001C500CA002P	3	500 MCM	34.5	35.0	82.5	11700	435	550
MVIC32CRUAYF001C600CA002P	3	600 MCM	36.5	37.1	87.0	13500	480	615
MVIC32CRUAYF001C750CA002P	3	750 MCM	39.0	39.5	92.0	15950	540	695
MVIC32CRUAYF001C01KCA002P	3	1000 MCM	42.5	43.0	99.5	19900	620	830

* Current Rating based on Table 310.16 (20°C Ambient Ground Temperature) and Table 310.17 (30°C Ambient Air Temperature) of National Electric Code



POLYCAB MV MC SCR ICEA S-93-639 25KV
MV Cable with Copper Conductor, EPR Insulation and Copper Screen

ELECTRICAL CHARACTERISTICS:

133% insulation:

No. of Cores	Core Cross sectional Area	Nom. DC Resistance at 25°C	Nom. AC Resistance at 90°C	Approx. Capacitance	Approx. Inductance	Approx. Reactance	Max. pulling tension on conductor	Charging Current per phase	Positive sequence impedance	Electric Stress at Conductor Screen	Short circuit rating	
											Phase conductor	Metallic screen
No.	AWG / MCM	Ω/km	Ω/km	μF/km	mH/km	Ω/km	kN	Amps/Km	Ohms/Km	kV/mm	kA/S	
1	2 AWG	0.531	0.666	0.15	0.47	0.18	2.4	1.39	0.69	5.8	4.8	3.3
1	1 AWG	0.423	0.528	0.16	0.45	0.17	3.0	1.48	0.56	5.6	6.1	3.4
1	1/0 AWG	0.335	0.420	0.17	0.44	0.17	3.7	1.57	0.45	5.3	7.7	3.5
1	2/0 AWG	0.266	0.331	0.18	0.41	0.16	4.7	1.68	0.37	5.1	9.7	3.6
1	3/0 AWG	0.211	0.266	0.19	0.40	0.15	6.0	1.81	0.31	4.9	12.2	3.8
1	4/0 AWG	0.167	0.210	0.21	0.38	0.15	7.5	1.94	0.26	4.7	15.3	3.9
1	250 MCM	0.141	0.177	0.22	0.38	0.14	8.9	2.07	0.23	4.5	18.1	4.1
1	350 MCM	0.101	0.128	0.25	0.35	0.13	12.4	2.32	0.19	4.3	25.4	4.4
1	500 MCM	0.071	0.092	0.28	0.33	0.13	17.7	2.62	0.16	4.1	36.2	4.8
1	600 MCM	0.059	0.076	0.31	0.33	0.12	21.3	2.88	0.15	3.8	43.5	5.1
1	750 MCM	0.047	0.066	0.33	0.32	0.12	26.6	3.11	0.14	3.7	54.4	5.4
1	1000 MCM	0.035	0.052	0.37	0.30	0.11	35.4	3.46	0.13	3.6	72.5	5.9

100% insulation:

No. of Cores	Core Cross sectional Area	Nom. DC Resistance at 25°C	Nom. AC Resistance at 90°C	Approx. Capacitance	Approx. Inductance	Approx. Reactance	Max. pulling tension on conductor	Charging Current per phase	Positive sequence impedance	Electric Stress at Conductor Screen	Short circuit rating	
											Phase conductor	Metallic screen
No.	AWG / MCM	Ω/km	Ω/km	μF/km	mH/km	Ω/km	kN	Amps/Km	Ohms/Km	kV/mm	kA/S	
1	2 AWG	0.531	0.666	0.17	0.45	0.17	2.4	1.58	1.11	6.5	4.8	2.9
1	1 AWG	0.423	0.528	0.18	0.43	0.16	3.0	1.68	0.88	6.2	6.1	3.0
1	1/0 AWG	0.335	0.420	0.19	0.42	0.16	3.7	1.80	0.71	6.0	7.7	3.1
1	2/0 AWG	0.266	0.331	0.21	0.39	0.15	4.7	1.94	0.57	5.7	9.7	3.2
1	3/0 AWG	0.211	0.266	0.22	0.38	0.14	6.0	2.08	0.46	5.5	12.2	3.4
1	4/0 AWG	0.167	0.210	0.24	0.36	0.14	7.5	2.25	0.37	5.3	15.3	3.6
1	250 MCM	0.141	0.177	0.26	0.36	0.13	8.9	2.41	0.32	5.1	18.1	3.7
1	350 MCM	0.101	0.128	0.29	0.34	0.13	12.4	2.70	0.25	4.9	25.4	4.0
1	500 MCM	0.071	0.092	0.33	0.32	0.12	17.7	3.07	0.19	4.7	36.2	4.4
1	600 MCM	0.059	0.076	0.35	0.31	0.12	21.3	3.32	0.17	4.5	43.5	4.7
1	750 MCM	0.047	0.066	0.38	0.30	0.11	26.6	3.61	0.15	4.4	54.4	5.0
1	1000 MCM	0.035	0.052	0.43	0.29	0.11	35.4	4.03	0.13	4.3	72.5	5.4



POLYCAB MV MC SCR ICEA S-93-639 35KV
MV Cable with Copper Conductor, EPR Insulation and Copper Screen

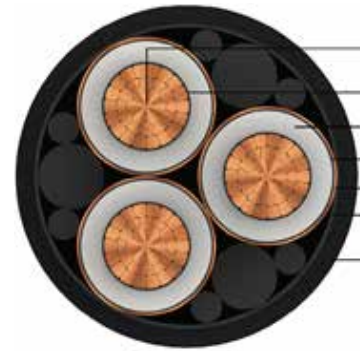

- Stranded Circular Compacted Copper Conductor
- Extruded Semi-Conducting Compound
- Extruded EPR Insulation
- Extruded Semi-Conducting Compound
- Helically applied Copper Tape
- Wrapping Tape
- Extruded Polyvinyl Chloride Outer Sheath

Outstanding Features

- Flame retardant
- High life
- Sunlight resistant
- Oil, Acid and Alkalies resistant
- Corona resistant
- Treeing resistant
- Moisture resistant

Application

POLYCAB MV 35KV EPR insulated with Copper conductor Three core cable is suitable to use in conduits, ducts, troughs, trays, direct burial in wet and dry conditions for power supply to wide networks.

Voltage Rating

Nominal Voltage: 35kV AC

Operation Temperature

Operating temperature: -35°C to +105°C
Emergency operating temperature: 140°C
Max. Short Circuit Temperature: 250°C

Construction

- Conductor: Circular Compacted Copper conductor as per ASTM B496
- Conductor Screen: Extruded Semi-conductive compound
- Insulation: Extruded EPR (TR-XLPE will be provided on demand)
- Insulation Screen: Extruded Semi-conductive compound
- Metallic Insulation Screen: Helically applied copper tape (Round / Corrugated copper screen will be provided on demand)
- Cores assembled together along with fillers (and ground wire optional)
- Binder: Wrapping tape (Armour will be provided on demand)
- Outer Sheath: Extruded Polyvinyl Chloride, Colour: Black (Alternative Sheath: CPE Outer Sheath or LSZH Outer sheath, and parameters will change accordingly)

Standard and References:

- ASTM B496
- ICEA S-93-639 (NEMA WC-74)
- UL 1072
- UL 1685 / FT-1
- IEEE 1202
- UL 2556

Voltage Rating (kV AC)	High Voltage Test (kV AC)	
	100% level	133% level
35	69	84

Compliance

- Conductor resistance ICEA S-93-639
- Insulation resistance ICEA S-93-639
- Vertical Tray Flame UL 1685
- Smoke Release UL 1685
- Flame Test IEEE 1202



POLYCAB MV MC SCR ICEA S-93-639 35KV
MV Cable with Copper Conductor, EPR Insulation and Copper Screen

DIMENSIONS, WEIGHT AND AMPACITY:

133% insulation:

Product Code	No. of Cores	Core Cross sectional Area	Nominal Diameter			Weight (Approx.) Kg/Km	Current rating *	
			Under metallic screen	Over metallic screen	Overall		Directly buried in ground	In air
	No.	AWG / MCM	mm	mm	mm	Amps		
MVIC46CRUAYF001C002AA001P	3	2 AWG	30.6	31.1	74.0	5450	130	155
MVIC46CRUAYF001C001AA001P	3	1 AWG	31.4	31.9	75.8	5900	150	175
MVIC46CRUAYF001C1X0AA001P	3	1/0 AWG	32.4	32.9	77.8	6350	170	205
MVIC46CRUAYF001C2X0AA001P	3	2/0 AWG	33.4	33.9	80.1	7000	200	240
MVIC46CRUAYF001C3X0AA001P	3	3/0 AWG	34.6	35.1	82.6	7750	225	280
MVIC46CRUAYF001C4X0AA001P	3	4/0 AWG	35.9	36.4	85.5	8600	265	320
MVIC46CRUAYF001C250CA001P	3	250 MCM	37.2	37.7	88.3	9400	290	360
MVIC46CRUAYF001C350CA001P	3	350 MCM	39.6	40.1	93.5	11300	355	450
MVIC46CRUAYF001C500CA001P	3	500 MCM	42.7	43.2	100.0	14000	435	550
MVIC46CRUAYF001C600CA001P	3	600 MCM	45.2	45.7	105.6	16100	480	615
MVIC46CRUAYF001C750CA001P	3	750 MCM	47.6	48.1	110.8	18650	540	695
MVIC46CRUAYF001C01KCA001P	3	1000 MCM	51.2	51.7	118.4	22750	620	830

100% insulation:

Product Code	No. of Cores	Core Cross sectional Area	Nominal Diameter			Weight (Approx.) Kg/Km	Current rating *	
			Under metallic screen	Over metallic screen	Overall		Directly buried in ground	In air
	No.	AWG / MCM	mm	mm	mm	Amps		
MVIC46CRUAYF001C002AA002P	3	2 AWG	26.8	27.3	64.5	4450	130	155
MVIC46CRUAYF001C001AA002P	3	1 AWG	27.6	28.1	66.3	4800	150	175
MVIC46CRUAYF001C1X0AA002P	3	1/0 AWG	28.5	29.1	68.4	5250	170	205
MVIC46CRUAYF001C2X0AA002P	3	2/0 AWG	29.6	30.1	70.6	5900	200	240
MVIC46CRUAYF001C3X0AA002P	3	3/0 AWG	30.8	31.3	74.4	6800	225	280
MVIC46CRUAYF001C4X0AA002P	3	4/0 AWG	32.1	32.6	77.2	7600	265	320
MVIC46CRUAYF001C250CA002P	3	250 MCM	33.4	33.9	80.0	8400	290	360
MVIC46CRUAYF001C350CA002P	3	350 MCM	35.8	36.3	85.3	10250	355	450
MVIC46CRUAYF001C500CA002P	3	500 MCM	38.8	39.4	91.8	12900	435	550
MVIC46CRUAYF001C600CA002P	3	600 MCM	40.9	41.4	96.2	14750	480	615
MVIC46CRUAYF001C750CA002P	3	750 MCM	43.3	43.8	101.4	17200	540	695
MVIC46CRUAYF001C01KCA002P	3	1000 MCM	46.8	47.3	109.0	21250	620	830

* Current Rating based on Table 310.16 (20°C Ambient Ground Temperature) and Table 310.17 (30°C Ambient Air Temperature) of National Electric Code



POLYCAB MV MC SCR ICEA S-93-639 35KV
MV Cable with Copper Conductor, EPR Insulation and Copper Screen

ELECTRICAL CHARACTERISTICS:

133% insulation:

No. of Cores	Core Cross sectional Area	Nom. DC Resistance at 25°C	Nom. AC Resistance at 90°C	Approx. Capacitance	Approx. Inductance	Approx. Reactance	Max. pulling tension on conductor	Charging Current per phase	Positive sequence impedance	Electric Stress at Conductor Screen	Short circuit rating	
											Phase conductor	Metallic screen
No.	AWG / MCM	Ω/km	Ω/km	μF/km	mH/km	Ω/km	kN	Amps/Km	Ohms/Km	kV/mm	kA/S	
1	2 AWG	0.531	0.666	0.13	0.51	0.19	2.4	1.66	0.69	7.1	4.8	3.9
1	1 AWG	0.423	0.528	0.13	0.49	0.19	3.0	1.76	0.56	6.7	6.1	4.0
1	1/0 AWG	0.335	0.420	0.14	0.47	0.18	3.7	1.87	0.46	6.4	7.7	4.1
1	2/0 AWG	0.266	0.331	0.15	0.45	0.17	4.7	1.99	0.37	6.1	9.7	4.3
1	3/0 AWG	0.211	0.266	0.16	0.43	0.16	6.0	2.12	0.31	5.8	12.2	4.4
1	4/0 AWG	0.167	0.210	0.17	0.41	0.16	7.5	2.27	0.26	5.5	15.3	4.6
1	250 MCM	0.141	0.177	0.18	0.40	0.15	8.9	2.41	0.23	5.3	18.1	4.7
1	350 MCM	0.101	0.128	0.20	0.38	0.14	12.4	2.68	0.19	5.0	25.4	5.0
1	500 MCM	0.071	0.092	0.23	0.36	0.14	17.7	3.01	0.16	4.7	36.2	5.4
1	600 MCM	0.059	0.076	0.25	0.35	0.13	21.3	3.28	0.15	4.5	43.5	5.7
1	750 MCM	0.047	0.066	0.27	0.34	0.13	26.6	3.54	0.14	4.4	54.4	6.1
1	1000 MCM	0.035	0.052	0.30	0.32	0.12	35.4	3.91	0.13	4.2	72.5	6.5

100% insulation:

No. of Cores	Core Cross sectional Area	Nom. DC Resistance at 25°C	Nom. AC Resistance at 90°C	Approx. Capacitance	Approx. Inductance	Approx. Reactance	Max. pulling tension on conductor	Charging Current per phase	Positive sequence impedance	Electric Stress at Conductor Screen	Short circuit rating	
											Phase conductor	Metallic screen
No.	AWG / MCM	Ω/km	Ω/km	μF/km	mH/km	Ω/km	kN	Amps/Km	Ohms/Km	kV/mm	kA/S	
1	2 AWG	0.531	0.666	0.14	0.48	0.18	2.4	1.86	1.11	7.8	4.8	3.4
1	1 AWG	0.423	0.528	0.15	0.46	0.18	3.0	1.97	0.89	7.5	6.1	3.5
1	1/0 AWG	0.335	0.420	0.16	0.45	0.17	3.7	2.10	0.71	7.1	7.7	3.7
1	2/0 AWG	0.266	0.331	0.17	0.42	0.16	4.7	2.25	0.57	6.8	9.7	3.8
1	3/0 AWG	0.211	0.266	0.18	0.41	0.15	6.0	2.41	0.46	6.5	12.2	3.9
1	4/0 AWG	0.167	0.210	0.20	0.39	0.15	7.5	2.58	0.38	6.2	15.3	4.1
1	250 MCM	0.141	0.177	0.21	0.38	0.14	8.9	2.75	0.33	6.0	18.1	4.3
1	350 MCM	0.101	0.128	0.23	0.36	0.14	12.4	3.07	0.25	5.7	25.4	4.6
1	500 MCM	0.071	0.092	0.26	0.34	0.13	17.7	3.47	0.19	5.4	36.2	4.9
1	600 MCM	0.059	0.076	0.28	0.33	0.13	21.3	3.73	0.18	5.2	43.5	5.2
1	750 MCM	0.047	0.066	0.31	0.32	0.12	26.6	4.04	0.16	5.1	54.4	5.5
1	1000 MCM	0.035	0.052	0.34	0.31	0.12	35.4	4.49	0.14	4.9	72.5	5.9



OUR CERTIFICATION
ISO 9001 | ISO 14001 | ISO 45001



POLYCAB MV MC SCR ICEA S-93-639 5KV (or) 8KV
MV Cable with Aluminium Conductor, EPR Insulation and Copper Screen

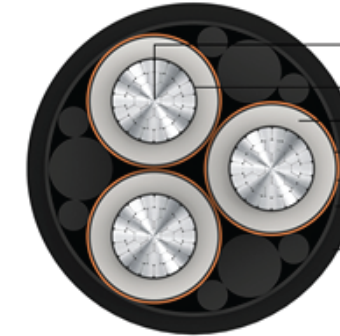

- Stranded Circular Compacted Copper Conductor
- Extruded Semi-Conducting Compound
- Extruded EPR Insulation
- Extruded Semi-Conducting Compound
- Helically applied Copper Tape
- Wrapping Tape
- Extruded Polyvinyl Chloride Outer Sheath

Outstanding Features

- Flame retardant
- High life
- Sunlight resistant
- Oil, Acid and Alkalies resistant
- Corona resistant
- Treeing resistant
- Moisture resistant

Application

POLYCAB MV 5 KV EPR insulated with Aluminium conductor Three core cable is suitable to use in conduits, ducts, troughs, trays, direct burial in wet and dry conditions for power supply to wide networks.

Voltage Rating

Nominal Voltage: 5kV AC (100% / 133%) or 8kV AC (100%)

Operation Temperature

Operating temperature: -35°C to +105°C
Emergency operating temperature: 140°C
Max. Short Circuit Temperature: 250°C

Construction

- Conductor: Circular Compacted Aluminium conductor as per ASTM B496
- Conductor Screen: Extruded Semi-conductive compound
- Insulation: Extruded EPR (TR-XLPE will be provided on demand)
- Insulation Screen: Extruded Semi-conductive compound
- Metallic Insulation Screen: Helically applied copper tape (*Round / Corrugated copper screen will be provided on demand*)
- Cores assembled together along with fillers (and ground wire optional)
- Binder: Wrapping tape (*Armour will be provided on demand*)
- Outer Sheath: Extruded Polyvinyl Chloride, Colour: Black (*Alternative Sheath: CPE Outer Sheath or LSZH Outer sheath, and parameters will change accordingly*)

Bending Radius: 7D

D is overall diameter of cable

Standard and References:

- ASTM B496
- ICEA S-93-639 (NEMA WC-74)
- UL 1072
- UL 1685 / FT-1
- IEEE 1202
- UL 2556

Voltage Rating (kV AC)	High Voltage Test (kV AC)	Min. Partial discharge test (kV AC)	
		100% level	133% level
5	18	4	5

Compliance

- Conductor resistance ICEA S-93-639
- Insulation resistance ICEA S-93-639
- Vertical Tray Flame UL 1685
- Smoke Release UL 1685
- Flame Test IEEE 1202



OUR CERTIFICATION
ISO 9001 | ISO 14001 | ISO 45001



POLYCAB MV MC SCR ICEA S-93-639 5KV (or) 8KV
MV Cable with Aluminium Conductor, EPR Insulation and Copper Screen

DIMENSIONS, WEIGHT AND AMPACITY:

133% insulation (5kV) and 100% insulation (8kV):

Product Code	No. of Cores	Core Cross sectional Area	Nominal Diameter			Weight (Approx.) Kg/Km	Current rating *	
			Under metallic screen	Over metallic screen	Overall		Directly buried in ground	In air
	No.	AWG / MCM	mm	mm	mm	Amps		
MVIC36ARUAYF003C002AA001P	3	2 AWG	15.1	15.6	37.5	1600	105	120
MVIC36ARUAYF003C001AA001P	3	1 AWG	15.9	16.4	39.5	1750	115	140
MVIC36ARUAYF003C1X0AA001P	3	1/0 AWG	16.9	17.4	41.5	1950	140	165
MVIC36ARUAYF003C2X0AA001P	3	2/0 AWG	17.9	18.4	44.0	2200	155	190
MVIC36ARUAYF003C3X0AA001P	3	3/0 AWG	19.1	19.6	48.0	2650	175	215
MVIC36ARUAYF003C4X0AA001P	3	4/0 AWG	20.4	20.9	51.0	2950	210	250
MVIC36ARUAYF003C250CA001P	3	250 MCM	21.7	22.2	53.5	3250	230	280
MVIC36ARUAYF003C350CA001P	3	350 MCM	24.1	24.6	59.0	4000	265	355
MVIC36ARUAYF003C500CA001P	3	500 MCM	27.2	27.7	65.5	4950	355	430
MVIC36ARUAYF003C600CA001P	3	600 MCM	29.7	30.2	72.0	6000	390	485
MVIC36ARUAYF003C750CA001P	3	750 MCM	32.1	32.7	77.5	6900	440	555
MVIC36ARUAYF003C01KCA001P	3	1000 MCM	35.7	36.2	85.0	8350	505	665

100% insulation (5kV):

Product Code	No. of Cores	Core Cross sectional Area	Nominal Diameter			Weight (Approx.) Kg/Km	Current rating *	
			Under metallic screen	Over metallic screen	Overall		Directly buried in ground	In air
	No.	AWG / MCM	mm	mm	mm	Amps		
MVIC36ARUAYF003C002AA002P	3	2 AWG	13.8	14.3	35.0	1450	105	120
MVIC36ARUAYF003C001AA002P	3	1 AWG	14.7	15.2	37.0	1600	115	140
MVIC36ARUAYF003C1X0AA002P	3	1/0 AWG	15.6	16.1	39.0	1750	140	165
MVIC36ARUAYF003C2X0AA002P	3	2/0 AWG	16.6	17.2	41.0	2050	155	190
MVIC36ARUAYF003C3X0AA002P	3	3/0 AWG	17.8	18.3	43.5	2300	175	215
MVIC36ARUAYF003C4X0AA002P	3	4/0 AWG	19.2	19.7	48.0	2750	210	250
MVIC36ARUAYF003C250CA002P	3	250 MCM	20.4	20.9	51.0	3050	230	280
MVIC36ARUAYF003C350CA002P	3	350 MCM	22.9	23.4	56.0	3750	265	355
MVIC36ARUAYF003C500CA002P	3	500 MCM	25.9	26.4	62.5	4700	355	430
MVIC36ARUAYF003C600CA002P	3	600 MCM	27.9	28.4	67.0	5400	390	485
MVIC36ARUAYF003C750CA002P	3	750 MCM	30.3	30.8	73.5	6450	440	555
MVIC36ARUAYF003C01KCA002P	3	1000 MCM	33.8	34.3	81.0	7850	505	665

* Current Rating based on Table 310.16 (20°C Ambient Ground Temperature) and Table 310.17 (30°C Ambient Air Temperature) of National Electric Code



POLYCAB MV MC SCR ICEA S-93-639 5KV (or) 8KV
MV Cable with Aluminium Conductor, EPR Insulation and Copper Screen

ELECTRICAL CHARACTERISTICS:

133% insulation:

No. of Cores	Core Cross sectional Area	Nom. DC Resistance at 25°C	Nom. AC Resistance at 90°C	Approx. Capacitance	Approx. Inductance	Approx. Reactance	Max. pulling tension on conductor	Charging Current per phase	Positive sequence impedance	Electric Stress at Conductor Screen	Short circuit rating	
											Phase conductor	Metallic screen
No.	AWG / MCM	Ω/km	Ω/km	μF/km	mH/km	Ω/km	kN	Amps/Km	Ohms/Km	kV/mm	kA/S	
1	2 AWG	0.531	0.666	0.30	0.37	0.14	1.7	0.56	1.11	2.1	3.0	2.0
1	1 AWG	0.423	0.528	0.32	0.36	0.13	2.1	0.60	0.88	2.1	3.8	2.1
1	1/0 AWG	0.335	0.420	0.35	0.34	0.13	2.7	0.66	0.71	2.0	4.8	2.2
1	2/0 AWG	0.266	0.331	0.38	0.32	0.12	3.4	0.71	0.56	1.9	6.0	2.3
1	3/0 AWG	0.211	0.266	0.41	0.31	0.12	4.3	0.78	0.45	1.9	7.6	2.5
1	4/0 AWG	0.167	0.210	0.45	0.30	0.11	5.4	0.85	0.37	1.9	9.6	2.6
1	250 MCM	0.141	0.177	0.49	0.30	0.11	6.4	0.92	0.31	1.8	11.3	2.8
1	350 MCM	0.101	0.128	0.56	0.28	0.11	8.9	1.05	0.24	1.7	15.9	3.1
1	500 MCM	0.071	0.092	0.64	0.27	0.10	12.8	1.21	0.18	1.7	22.6	3.5
1	600 MCM	0.059	0.076	0.72	0.27	0.10	15.3	1.35	0.16	1.5	27.2	3.8
1	750 MCM	0.047	0.066	0.79	0.26	0.10	19.2	1.48	0.14	1.5	34.0	4.1
1	1000 MCM	0.035	0.052	0.89	0.25	0.10	25.5	1.67	0.12	1.5	45.3	4.5

100% insulation:

No. of Cores	Core Cross sectional Area	Nom. DC Resistance at 25°C	Nom. AC Resistance at 90°C	Approx. Capacitance	Approx. Inductance	Approx. Reactance	Max. pulling tension on conductor	Charging Current per phase	Positive sequence impedance	Electric Stress at Conductor Screen	Short circuit rating	
											Phase conductor	Metallic screen
No.	AWG / MCM	Ω/km	Ω/km	μF/km	mH/km	Ω/km	kN	Amps/Km	Ohms/Km	kV/mm	kA/S	
1	2 AWG	0.531	0.666	0.36	0.35	0.13	1.7	0.68	1.11	2.5	3.0	1.8
1	1 AWG	0.423	0.528	0.39	0.34	0.13	2.1	0.73	0.88	2.4	3.8	1.9
1	1/0 AWG	0.335	0.420	0.42	0.33	0.12	2.7	0.80	0.71	2.4	4.8	2.0
1	2/0 AWG	0.266	0.331	0.46	0.31	0.12	3.4	0.87	0.56	2.3	6.0	2.2
1	3/0 AWG	0.211	0.266	0.51	0.30	0.11	4.3	0.95	0.45	2.2	7.6	2.3
1	4/0 AWG	0.167	0.210	0.56	0.29	0.11	5.4	1.05	0.36	2.2	9.6	2.5
1	250 MCM	0.141	0.177	0.60	0.29	0.11	6.4	1.14	0.31	2.1	11.3	2.6
1	350 MCM	0.101	0.128	0.69	0.27	0.10	8.9	1.30	0.24	2.0	15.9	2.9
1	500 MCM	0.071	0.092	0.80	0.26	0.10	12.8	1.51	0.18	2.0	22.6	3.3
1	600 MCM	0.059	0.076	0.88	0.26	0.10	15.3	1.65	0.16	1.9	27.2	3.6
1	750 MCM	0.047	0.066	0.96	0.25	0.09	19.2	1.82	0.14	1.9	34.0	3.9
1	1000 MCM	0.035	0.052	1.09	0.24	0.09	25.5	2.06	0.12	1.9	45.3	4.3



POLYCAB MV MC SCR ICEA S-93-639 8KV
MV Cable with Aluminium Conductor, EPR Insulation and Copper Screen

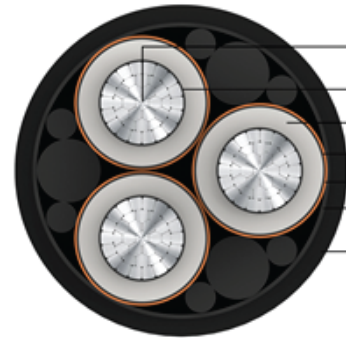

- Stranded Circular Compacted Copper Conductor
- Extruded Semi-Conducting Compound
- Extruded EPR Insulation
- Extruded Semi-Conducting Compound
- Helically applied Copper Tape
- Wrapping Tape
- Extruded Polyvinyl Chloride Outer Sheath

Outstanding Features

- Flame retardant
- High life
- Sunlight resistant
- Oil, Acid and Alkalies resistant
- Corona resistant
- Treeing resistant
- Moisture resistant

Application

POLYCAB MV 8KV EPR insulated with Aluminium conductor Three core cable is suitable to use in conduits, ducts, troughs, trays, direct burial in wet and dry conditions for power supply to wide networks.

Voltage Rating

Nominal Voltage: 8kV AC

Operation Temperature

Operating temperature: -35°C to +105°C
Emergency operating temperature: 140°C
Max. Short Circuit Temperature: 250°C

Construction

- Conductor: Circular Compacted Aluminium conductor as per ASTM B496
- Conductor Screen: Extruded Semi-conductive compound
- Insulation: Extruded EPR (TR-XLPE will be provided on demand)
- Insulation Screen: Extruded Semi-conductive compound
- Metallic Insulation Screen: Helically applied copper tape (Round / Corrugated copper screen will be provided on demand)
- Cores assembled together along with fillers (and ground wire optional)
- Binder: Wrapping tape (Armour will be provided on demand)
- Outer Sheath: Extruded Polyvinyl Chloride, Colour: Black (Alternative Sheath: CPE Outer Sheath or LSZH Outer sheath, and parameters will change accordingly)

Bending Radius: 7D

D is overall diameter of cable

Standard and References:

- ASTM B496
- ICEA S-93-639 (NEMA WC-74)
- UL 1072
- UL 1685 / FT-1
- IEEE 1202
- UL 2556

Voltage Rating (kV AC)	High Voltage Test (kV AC)		Min. Partial discharge test (kV AC)	
	100% level	133% level	100% level	133% level
8	23	28	6	8

Compliance

- Conductor resistance ICEA S-93-639
- Insulation resistance ICEA S-93-639
- Vertical Tray Flame UL 1685
- Smoke Release UL 1685
- Flame Test IEEE 1202



POLYCAB MV MC SCR ICEA S-93-639 8KV
MV Cable with Aluminium Conductor, EPR Insulation and Copper Screen

DIMENSIONS, WEIGHT AND AMPACITY:

133% insulation:

Product Code	No. of Cores	Core Cross sectional Area	Nominal Diameter			Weight (Approx.) Kg/Km	Current rating *	
			Under metallic screen	Over metallic screen	Overall		Directly buried in ground	In air
	No.	AWG / MCM	mm	mm	mm	Amps		
MVIC48ARUAYF003C002AA001P	3	2 AWG	16.4	16.9	40.5	1800	105	120
MVIC48ARUAYF003C001AA001P	3	1 AWG	17.2	17.7	42.5	1950	115	140
MVIC48ARUAYF003C1X0AA001P	3	1/0 AWG	18.1	18.6	46.0	2300	140	165
MVIC48ARUAYF003C2X0AA001P	3	2/0 AWG	19.2	19.7	48.0	2600	155	190
MVIC48ARUAYF003C3X0AA001P	3	3/0 AWG	20.4	20.9	50.5	2850	175	215
MVIC48ARUAYF003C4X0AA001P	3	4/0 AWG	21.7	22.2	53.5	3200	210	250
MVIC48ARUAYF003C250CA001P	3	250 MCM	23.0	23.5	56.5	3500	230	280
MVIC48ARUAYF003C350CA001P	3	350 MCM	25.4	25.9	61.5	4250	265	355
MVIC48ARUAYF003C500CA001P	3	500 MCM	28.4	28.9	68.0	5250	355	430
MVIC48ARUAYF003C600CA001P	3	600 MCM	31.0	31.5	75.0	6300	390	485
MVIC48ARUAYF003C750CA001P	3	750 MCM	33.4	33.9	80.0	7200	440	555
MVIC48ARUAYF003C01KCA001P	3	1000 MCM	36.9	37.4	87.5	8700	505	665

100% insulation:

Product Code	No. of Cores	Core Cross sectional Area	Nominal Diameter			Weight (Approx.) Kg/Km	Current rating *	
			Under metallic screen	Over metallic screen	Overall		Directly buried in ground	In air
	No.	AWG / MCM	mm	mm	mm	Amps		
MVIC48ARUAYF003C002AA002P	3	2 AWG	15.1	15.6	37.5	1600	105	120
MVIC48ARUAYF003C001AA002P	3	1 AWG	15.9	16.4	39.5	1750	115	140
MVIC48ARUAYF003C1X0AA002P	3	1/0 AWG	16.9	17.4	41.5	1950	140	165
MVIC48ARUAYF003C2X0AA002P	3	2/0 AWG	17.9	18.4	44.0	2200	155	190
MVIC48ARUAYF003C3X0AA002P	3	3/0 AWG	19.1	19.6	48.0	2650	175	215
MVIC48ARUAYF003C4X0AA002P	3	4/0 AWG	20.4	20.9	51.0	2950	210	250
MVIC48ARUAYF003C250CA002P	3	250 MCM	21.7	22.2	53.5	3250	230	280
MVIC48ARUAYF003C350CA002P	3	350 MCM	24.1	24.6	59.0	4000	265	355
MVIC48ARUAYF003C500CA002P	3	500 MCM	27.2	27.7	65.5	4950	355	430
MVIC48ARUAYF003C600CA002P	3	600 MCM	29.7	30.2	72.0	6000	390	485
MVIC48ARUAYF003C750CA002P	3	750 MCM	32.1	32.7	77.5	6900	440	555
MVIC48ARUAYF003C01KCA002P	3	1000 MCM	35.7	36.2	85.0	8350	505	665

* Current Rating based on Table 310.16 (20°C Ambient Ground Temperature) and Table 310.17 (30°C Ambient Air Temperature) of National Electric Code



POLYCAB MV MC SCR ICEA S-93-639 8KV
MV Cable with Aluminium Conductor, EPR Insulation and Copper Screen

ELECTRICAL CHARACTERISTICS:

133% insulation:

No. of Cores	Core Cross sectional Area	Nom. DC Resistance at 25°C	Nom. AC Resistance at 90°C	Approx. Capacitance	Approx. Inductance	Approx. Reactance	Max. pulling tension on conductor	Charging Current per phase	Positive sequence impedance	Electric Stress at Conductor Screen	Short circuit rating	
											Phase conductor	Metallic screen
No.	AWG / MCM	Ω/km	Ω/km	μF/km	mH/km	Ω/km	kN	Amps/Km	Ohms/Km	kV/mm	kA/S	
1	2 AWG	0.531	0.666	0.26	0.38	0.15	1.7	0.77	1.11	3.0	3.0	2.1
1	1 AWG	0.423	0.528	0.28	0.37	0.14	2.1	0.83	0.88	2.9	3.8	2.2
1	1/0 AWG	0.335	0.420	0.30	0.36	0.14	2.7	0.90	0.71	2.8	4.8	2.3
1	2/0 AWG	0.266	0.331	0.32	0.34	0.13	3.4	0.98	0.56	2.7	6.0	2.5
1	3/0 AWG	0.211	0.266	0.35	0.33	0.12	4.3	1.06	0.45	2.7	7.6	2.6
1	4/0 AWG	0.167	0.210	0.38	0.32	0.12	5.4	1.16	0.37	2.6	9.6	2.8
1	250 MCM	0.141	0.177	0.41	0.31	0.12	6.4	1.25	0.32	2.5	11.3	3.0
1	350 MCM	0.101	0.128	0.47	0.29	0.11	8.9	1.42	0.24	2.4	15.9	3.3
1	500 MCM	0.071	0.092	0.54	0.28	0.11	12.8	1.64	0.18	2.3	22.6	3.6
1	600 MCM	0.059	0.076	0.60	0.28	0.10	15.3	1.82	0.16	2.1	27.2	4.0
1	750 MCM	0.047	0.066	0.66	0.27	0.10	19.2	1.99	0.14	2.1	34.0	4.3
1	1000 MCM	0.035	0.052	0.74	0.26	0.10	25.5	2.24	0.12	2.1	45.3	4.7

100% insulation:

No. of Cores	Core Cross sectional Area	Nom. DC Resistance at 25°C	Nom. AC Resistance at 90°C	Approx. Capacitance	Approx. Inductance	Approx. Reactance	Max. pulling tension on conductor	Charging Current per phase	Positive sequence impedance	Electric Stress at Conductor Screen	Short circuit rating	
											Phase conductor	Metallic screen
No.	AWG / MCM	Ω/km	Ω/km	μF/km	mH/km	Ω/km	kN	Amps/Km	Ohms/Km	kV/mm	kA/S	
1	2 AWG	0.531	0.666	0.30	0.37	0.14	1.7	0.56	1.11	2.1	3.0	2.0
1	1 AWG	0.423	0.528	0.32	0.36	0.13	2.1	0.60	0.88	2.1	3.8	2.1
1	1/0 AWG	0.335	0.420	0.35	0.34	0.13	2.7	0.66	0.71	2.0	4.8	2.2
1	2/0 AWG	0.266	0.331	0.38	0.32	0.12	3.4	0.71	0.56	1.9	6.0	2.3
1	3/0 AWG	0.211	0.266	0.41	0.31	0.12	4.3	0.78	0.45	1.9	7.6	2.5
1	4/0 AWG	0.167	0.210	0.45	0.30	0.11	5.4	0.85	0.37	1.9	9.6	2.6
1	250 MCM	0.141	0.177	0.49	0.30	0.11	6.4	0.92	0.31	1.8	11.3	2.8
1	350 MCM	0.101	0.128	0.56	0.28	0.11	8.9	1.05	0.24	1.7	15.9	3.1
1	500 MCM	0.071	0.092	0.64	0.27	0.10	12.8	1.21	0.18	1.7	22.6	3.5
1	600 MCM	0.059	0.076	0.72	0.27	0.10	15.3	1.35	0.16	1.5	27.2	3.8
1	750 MCM	0.047	0.066	0.79	0.26	0.10	19.2	1.48	0.14	1.5	34.0	4.1
1	1000 MCM	0.035	0.052	0.89	0.25	0.10	25.5	1.67	0.12	1.5	45.3	4.5



OUR CERTIFICATION
 ISO 9001 | ISO 14001 | ISO 45001



POLYCAB MV MC SCR ICEA S-93-639 15KV
MV Cable with Aluminium Conductor, EPR Insulation and Copper Screen

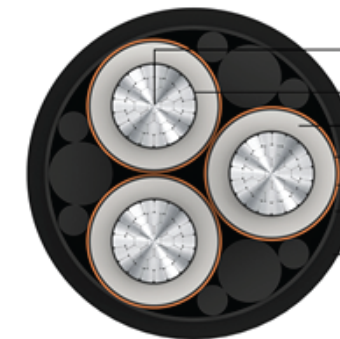

- Stranded Circular Compacted Copper Conductor
- Extruded Semi-Conducting Compound
- Extruded EPR Insulation
- Extruded Semi-Conducting Compound
- Helically applied Copper Tape
- Wrapping Tape
- Extruded Polyvinyl Chloride Outer Sheath

Outstanding Features

- Flame retardant
- High life
- Sunlight resistant
- Oil, Acid and Alkalies resistant
- Corona resistant
- Treeing resistant
- Moisture resistant

Application

POLYCAB MV 15KV EPR insulated with Aluminium conductor Three core cable is suitable to use in conduits, ducts, troughs, trays, direct burial in wet and dry conditions for power supply to wide networks.

Voltage Rating

Nominal Voltage: 15kV AC

Operation Temperature

Operating temperature: -35°C to +105°C
 Emergency operating temperature: 140°C
 Max. Short Circuit Temperature: 250°C

Construction

- Conductor: Circular Compacted Aluminium conductor as per ASTM B496
- Conductor Screen: Extruded Semi-conductive compound
- Insulation: Extruded EPR (TR-XLPE will be provided on demand)
- Insulation Screen: Extruded Semi-conductive compound
- Metallic Insulation Screen: Helically applied copper tape (*Round / Corrugated copper screen will be provided on demand*)
- Cores assembled together along with fillers (and ground wire optional)
- Binder: Wrapping tape (*Armour will be provided on demand*)
- Outer Sheath: Extruded Polyvinyl Chloride, Colour: Black (*Alternative Sheath: CPE Outer Sheath or LSZH Outer sheath, and parameters will change accordingly*)

Bending Radius: 7D

D is overall diameter of cable

Standard and References:

- ASTM B496
- ICEA S-93-639 (NEMA WC-74)
- UL 1072
- UL 1685 / FT-1
- IEEE 1202
- UL 2556

Voltage Rating (kV AC)	High Voltage Test (kV AC)		Min. Partial discharge test (kV AC)	
	100% level	133% level	100% level	133% level
15	35	44	11	15

Compliance

- Conductor resistance ICEA S-93-639
- Insulation resistance ICEA S-93-639
- Vertical Tray Flame UL 1685
- Smoke Release UL 1685
- Flame Test IEEE 1202



OUR CERTIFICATION
 ISO 9001 | ISO 14001 | ISO 45001



POLYCAB MV MC SCR ICEA S-93-639 15KV
MV Cable with Aluminium Conductor, EPR Insulation and Copper Screen

DIMENSIONS, WEIGHT AND AMPACITY:

133% insulation:

Product Code	No. of Cores	Core Cross sectional Area	Nominal Diameter			Weight (Approx.) Kg/Km	Current rating *	
			Under metallic screen	Over metallic screen	Overall		Directly buried in ground	In air
	No.	AWG / MCM	mm	mm	mm	Amps		
MVIC37ARUAYF003C002AA001P	3	2 AWG	20.4	20.9	51.0	2600	105	120
MVIC37ARUAYF003C001AA001P	3	1 AWG	21.3	21.8	52.5	2750	115	140
MVIC37ARUAYF003C1X0AA001P	3	1/0 AWG	22.2	22.7	54.5	3000	140	165
MVIC37ARUAYF003C2X0AA001P	3	2/0 AWG	23.3	23.8	57.0	3300	155	190
MVIC37ARUAYF003C3X0AA001P	3	3/0 AWG	24.4	24.9	59.5	3600	175	215
MVIC37ARUAYF003C4X0AA001P	3	4/0 AWG	25.8	26.3	62.5	3950	210	250
MVIC37ARUAYF003C250CA001P	3	250 MCM	27.0	27.6	65.0	4300	230	280
MVIC37ARUAYF003C350CA001P	3	350 MCM	29.5	30.0	70.5	5100	265	355
MVIC37ARUAYF003C500CA001P	3	500 MCM	32.5	33.0	78.0	6400	355	430
MVIC37ARUAYF003C600CA001P	3	600 MCM	35.1	35.6	83.5	7350	390	485
MVIC37ARUAYF003C750CA001P	3	750 MCM	37.5	38.0	89.0	8300	440	555
MVIC37ARUAYF003C01KCA001P	3	1000 MCM	41.0	41.5	96.5	9850	505	665

100% insulation

Product Code	No. of Cores	Core Cross sectional Area	Nominal Diameter			Weight (Approx.) Kg/Km	Current rating *	
			Under metallic screen	Over metallic screen	Overall		Directly buried in ground	In air
	No.	AWG / MCM	mm	mm	mm	Amps		
MVIC37ARUAYF003C002AA002P	3	2 AWG	18.1	18.7	46.0	2200	105	120
MVIC37ARUAYF003C001AA002P	3	1 AWG	19.0	19.5	47.5	2400	115	140
MVIC37ARUAYF003C1X0AA002P	3	1/0 AWG	19.9	20.4	49.5	2600	140	165
MVIC37ARUAYF003C2X0AA002P	3	2/0 AWG	21.0	21.5	52.0	2900	155	190
MVIC37ARUAYF003C3X0AA002P	3	3/0 AWG	22.2	22.7	54.5	3150	175	215
MVIC37ARUAYF003C4X0AA002P	3	4/0 AWG	23.5	24.0	57.5	3500	210	250
MVIC37ARUAYF003C250CA002P	3	250 MCM	24.8	25.3	60.0	3850	230	280
MVIC37ARUAYF003C350CA002P	3	350 MCM	27.2	27.7	65.5	4600	265	355
MVIC37ARUAYF003C500CA002P	3	500 MCM	30.2	30.7	73.0	5850	355	430
MVIC37ARUAYF003C600CA002P	3	600 MCM	32.2	32.7	77.5	6600	390	485
MVIC37ARUAYF003C750CA002P	3	750 MCM	34.6	35.1	82.5	7550	440	555
MVIC37ARUAYF003C01KCA002P	3	1000 MCM	38.2	38.7	90.5	9050	505	665

* Current Rating based on Table 310.16 (20°C Ambient Ground Temperature) and Table 310.17 (30°C Ambient Air Temperature) of National Electric Code



OUR CERTIFICATION
 ISO 9001 | ISO 14001 | ISO 45001

POLYCAB MV MC SCR ICEA S-93-639 15KV
MV Cable with Aluminium Conductor, EPR Insulation and Copper Screen

ELECTRICAL CHARACTERISTICS:

133% insulation:

No. of Cores	Core Cross sectional Area	Nom. DC Resistance at 25°C	Nom. AC Resistance at 90°C	Approx. Capacitance	Approx. Inductance	Approx. Reactance	Max. pulling tension on conductor	Charging Current per phase	Positive sequence impedance	Electric Stress at Conductor Screen	Short circuit rating	
											Phase conductor	Metallic screen
No.	AWG / MCM	Ω/km	Ω/km	μF/km	mH/km	Ω/km	kN	Amps/Km	Ohms/Km	kV/mm	kA/S	
1	2 AWG	0.531	0.666	0.19	0.43	0.16	1.7	1.05	1.11	4.3	3.0	2.6
1	1 AWG	0.423	0.528	0.20	0.41	0.16	2.1	1.13	0.89	4.1	3.8	2.7
1	1/0 AWG	0.335	0.420	0.21	0.40	0.15	2.7	1.21	0.71	4.0	4.8	2.9
1	2/0 AWG	0.266	0.331	0.23	0.38	0.14	3.4	1.30	0.57	3.8	6.0	3.0
1	3/0 AWG	0.211	0.266	0.25	0.36	0.14	4.3	1.41	0.46	3.7	7.6	3.1
1	4/0 AWG	0.167	0.210	0.27	0.35	0.13	5.4	1.52	0.37	3.6	9.6	3.3
1	250 MCM	0.141	0.177	0.29	0.34	0.13	6.4	1.64	0.32	3.4	11.3	3.5
1	350 MCM	0.101	0.128	0.33	0.32	0.12	8.9	1.84	0.24	3.3	15.9	3.8
1	500 MCM	0.071	0.092	0.37	0.31	0.12	12.8	2.11	0.19	3.2	22.6	4.1
1	600 MCM	0.059	0.076	0.41	0.30	0.11	15.3	2.33	0.17	3.0	27.2	4.5
1	750 MCM	0.047	0.066	0.45	0.29	0.11	19.2	2.53	0.15	2.9	34.0	4.8
1	1000 MCM	0.035	0.052	0.50	0.28	0.11	25.5	2.83	0.13	2.8	45.3	5.2

100% insulation:

No. of Cores	Core Cross sectional Area	Nom. DC Resistance at 25°C	Nom. AC Resistance at 90°C	Approx. Capacitance	Approx. Inductance	Approx. Reactance	Max. pulling tension on conductor	Charging Current per phase	Positive sequence impedance	Electric Stress at Conductor Screen	Short circuit rating	
											Phase conductor	Metallic screen
No.	AWG / MCM	Ω/km	Ω/km	μF/km	mH/km	Ω/km	kN	Amps/Km	Ohms/Km	kV/mm	kA/S	
1	2 AWG	0.531	0.666	0.22	0.40	0.15	1.7	1.23	1.11	4.9	3.0	2.3
1	1 AWG	0.423	0.528	0.23	0.39	0.15	2.1	1.32	0.88	4.8	3.8	2.5
1	1/0 AWG	0.335	0.420	0.25	0.38	0.14	2.7	1.43	0.71	4.6	4.8	2.6
1	2/0 AWG	0.266	0.331	0.27	0.35	0.13	3.4	1.54	0.57	4.4	6.0	2.7
1	3/0 AWG	0.211	0.266	0.30	0.34	0.13	4.3	1.67	0.45	4.3	7.6	2.9
1	4/0 AWG	0.167	0.210	0.32	0.33	0.12	5.4	1.81	0.37	4.2	9.6	3.0
1	250 MCM	0.141	0.177	0.35	0.32	0.12	6.4	1.95	0.32	4.0	11.3	3.2
1	350 MCM	0.101	0.128	0.39	0.31	0.12	8.9	2.22	0.24	3.9	15.9	3.5
1	500 MCM	0.071	0.092	0.45	0.29	0.11	12.8	2.54	0.18	3.7	22.6	3.9
1	600 MCM	0.059	0.076	0.49	0.29	0.11	15.3	2.76	0.17	3.6	27.2	4.1
1	750 MCM	0.047	0.066	0.53	0.28	0.10	19.2	3.01	0.15	3.5	34.0	4.4
1	1000 MCM	0.035	0.052	0.60	0.27	0.10	25.5	3.39	0.13	3.5	45.3	4.9



OUR CERTIFICATION
 ISO 9001 | ISO 14001 | ISO 45001



POLYCAB MV MC SCR ICEA S-93-639 25KV
MV Cable with Aluminium Conductor, EPR Insulation and Copper Screen

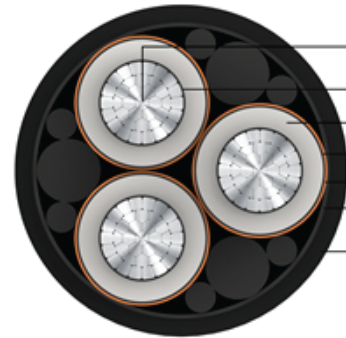

- Stranded Circular Compacted Copper Conductor
- Extruded Semi-Conducting Compound
- Extruded EPR Insulation
- Extruded Semi-Conducting Compound
- Helically applied Copper Tape
- Wrapping Tape
- Extruded Polyvinyl Chloride Outer Sheath

Outstanding Features

- Flame retardant
- High life
- Sunlight resistant
- Oil, Acid and Alkalies resistant
- Corona resistant
- Treeing resistant
- Moisture resistant

Application

POLYCAB MV 25KV EPR insulated with Aluminium conductor Three core cable is suitable to use in conduits, ducts, troughs, trays, direct burial in wet and dry conditions for power supply to wide networks.

Voltage Rating

Nominal Voltage: 25kV AC

Operation Temperature

Operating temperature: -35°C to +105°C
Emergency operating temperature: 140°C
Max. Short Circuit Temperature: 250°C

Construction

- Conductor: Circular Compacted Aluminium conductor as per ASTM B496
- Conductor Screen: Extruded Semi-conductive compound
- Insulation: Extruded EPR (TR-XLPE will be provided on demand)
- Insulation Screen: Extruded Semi-conductive compound
- Metallic Insulation Screen: Helically applied copper tape (Round / Corrugated copper screen will be provided on demand)
- Cores assembled together along with fillers (and ground wire optional)
- Binder: Wrapping tape (Armour will be provided on demand)
- Outer Sheath: Extruded Polyvinyl Chloride, Colour: Black (Alternative Sheath: CPE Outer Sheath or LSZH Outer sheath, and parameters will change accordingly)

Standard and References:

- ASTM B496
- ICEA S-93-639 (NEMA WC-74)
- UL 1072
- UL 1685 / FT-1
- IEEE 1202
- UL 2556

Voltage Rating (kV AC)	High Voltage Test (kV AC)	
	100% level	133% level
25	52	64

Compliance

- Conductor resistance ICEA S-93-639
- Insulation resistance ICEA S-93-639
- Vertical Tray Flame UL 1685
- Smoke Release UL 1685
- Flame Test IEEE 1202



POLYCAB MV MC SCR ICEA S-93-639 25KV
MV Cable with Aluminium Conductor, EPR Insulation and Copper Screen

DIMENSIONS, WEIGHT AND AMPACITY:

133% insulation:

Product Code	No. of Cores	Core Cross sectional Area	Nominal Diameter			Weight (Approx.) Kg/Km	Current rating *	
			Under metallic screen	Over metallic screen	Overall		Directly buried in ground	In air
	No.	AWG / MCM	mm	mm	mm	Amps		
MVIC32ARUAYF001C002AA001P	3	2 AWG	25.5	26.0	62.0	3550	105	120
MVIC32ARUAYF001C001AA001P	3	1 AWG	26.3	26.9	63.5	3750	115	140
MVIC32ARUAYF001C1X0AA001P	3	1/0 AWG	27.3	27.8	65.5	4000	140	165
MVIC32ARUAYF001C2X0AA001P	3	2/0 AWG	28.3	28.8	68.0	4350	155	190
MVIC32ARUAYF001C3X0AA001P	3	3/0 AWG	29.5	30.0	70.5	4650	175	215
MVIC32ARUAYF001C4X0AA001P	3	4/0 AWG	30.8	31.3	74.5	5250	210	250
MVIC32ARUAYF001C250CA001P	3	250 MCM	32.1	32.6	77.5	5650	230	280
MVIC32ARUAYF001C350CA001P	3	350 MCM	34.5	35.1	82.5	6550	265	355
MVIC32ARUAYF001C500CA001P	3	500 MCM	37.6	38.1	89.0	7750	355	430
MVIC32ARUAYF001C600CA001P	3	600 MCM	40.2	40.7	94.5	8750	390	485
MVIC32ARUAYF001C750CA001P	3	750 MCM	42.6	43.1	100.0	9800	440	555
MVIC32ARUAYF001C01KCA001P	3	1000 MCM	46.1	46.6	107.5	11450	505	665

100% insulation:

Product Code	No. of Cores	Core Cross sectional Area	Nominal Diameter			Weight (Approx.) Kg/Km	Current rating *	
			Under metallic screen	Over metallic screen	Overall		Directly buried in ground	In air
	No.	AWG / MCM	mm	mm	mm	Amps		
MVIC32ARUAYF001C002AA002P	3	2 AWG	22.5	23.0	55.0	2950	105	120
MVIC32ARUAYF001C001AA002P	3	1 AWG	23.3	23.8	57.0	3150	115	140
MVIC32ARUAYF001C1X0AA002P	3	1/0 AWG	24.2	24.7	59.0	3350	140	165
MVIC32ARUAYF001C2X0AA002P	3	2/0 AWG	25.3	25.8	61.5	3700	155	190
MVIC32ARUAYF001C3X0AA002P	3	3/0 AWG	26.5	27.0	64.0	4000	175	215
MVIC32ARUAYF001C4X0AA002P	3	4/0 AWG	27.8	28.3	66.5	4400	210	250
MVIC32ARUAYF001C250CA002P	3	250 MCM	29.1	29.6	69.5	4750	230	280
MVIC32ARUAYF001C350CA002P	3	350 MCM	31.5	32.0	76.0	5750	265	355
MVIC32ARUAYF001C500CA002P	3	500 MCM	34.5	35.0	82.5	6900	355	430
MVIC32ARUAYF001C600CA002P	3	600 MCM	36.5	37.1	87.0	7750	390	485
MVIC32ARUAYF001C750CA002P	3	750 MCM	39.0	39.5	92.0	8750	440	555
MVIC32ARUAYF001C01KCA002P	3	1000 MCM	42.5	43.0	99.5	10300	505	665

* Current Rating based on Table 310.16 (20°C Ambient Ground Temperature) and Table 310.17 (30°C Ambient Air Temperature) of National Electric Code



POLYCAB MV MC SCR ICEA S-93-639 25KV
MV Cable with Aluminium Conductor, EPR Insulation and Copper Screen

ELECTRICAL CHARACTERISTICS:

133% insulation:

No. of Cores	Core Cross sectional Area	Nom. DC Resistance at 25°C	Nom. AC Resistance at 90°C	Approx. Capacitance	Approx. Inductance	Approx. Reactance	Max. pulling tension on conductor	Charging Current per phase	Positive sequence impedance	Electric Stress at Conductor Screen	Short circuit rating	
											Phase conductor	Metallic screen
No.	AWG / MCM	Ω/km	Ω/km	μF/km	mH/km	Ω/km	kN	Amps/Km	Ohms/Km	kV/mm	kA/S	
1	2 AWG	0.531	0.666	0.15	0.47	0.18	2.4	1.39	1.11	5.8	3.0	3.3
1	1 AWG	0.423	0.528	0.16	0.45	0.17	3.0	1.48	0.89	5.6	3.8	3.4
1	1/0 AWG	0.335	0.420	0.17	0.44	0.17	3.7	1.57	0.71	5.3	4.8	3.5
1	2/0 AWG	0.266	0.331	0.18	0.41	0.16	4.7	1.68	0.57	5.1	6.0	3.6
1	3/0 AWG	0.211	0.266	0.19	0.40	0.15	6.0	1.81	0.46	4.9	7.6	3.8
1	4/0 AWG	0.167	0.210	0.21	0.38	0.15	7.5	1.94	0.38	4.7	9.6	3.9
1	250 MCM	0.141	0.177	0.22	0.38	0.14	8.9	2.07	0.33	4.5	11.3	4.1
1	350 MCM	0.101	0.128	0.25	0.35	0.13	12.4	2.32	0.25	4.3	15.9	4.4
1	500 MCM	0.071	0.092	0.28	0.33	0.13	17.7	2.62	0.19	4.1	22.6	4.8
1	600 MCM	0.059	0.076	0.31	0.33	0.12	21.3	2.88	0.18	3.8	27.2	5.1
1	750 MCM	0.047	0.066	0.33	0.32	0.12	26.6	3.11	0.16	3.7	34.0	5.4
1	1000 MCM	0.035	0.052	0.37	0.30	0.11	35.4	3.46	0.14	3.6	45.3	5.9

100% insulation:

No. of Cores	Core Cross sectional Area	Nom. DC Resistance at 25°C	Nom. AC Resistance at 90°C	Approx. Capacitance	Approx. Inductance	Approx. Reactance	Max. pulling tension on conductor	Charging Current per phase	Positive sequence impedance	Electric Stress at Conductor Screen	Short circuit rating	
											Phase conductor	Metallic screen
No.	AWG / MCM	Ω/km	Ω/km	μF/km	mH/km	Ω/km	kN	Amps/Km	Ohms/Km	kV/mm	kA/S	
1	2 AWG	0.531	0.666	0.17	0.45	0.17	2.4	1.58	1.11	6.5	3.0	2.9
1	1 AWG	0.423	0.528	0.18	0.43	0.16	3.0	1.68	0.89	6.2	3.8	3.0
1	1/0 AWG	0.335	0.420	0.19	0.42	0.16	3.7	1.80	0.71	6.0	4.8	3.1
1	2/0 AWG	0.266	0.331	0.21	0.39	0.15	4.7	1.94	0.57	5.7	6.0	3.2
1	3/0 AWG	0.211	0.266	0.22	0.38	0.14	6.0	2.08	0.46	5.5	7.6	3.4
1	4/0 AWG	0.167	0.210	0.24	0.36	0.14	7.5	2.25	0.37	5.3	9.6	3.6
1	250 MCM	0.141	0.177	0.26	0.36	0.13	8.9	2.41	0.32	5.1	11.3	3.7
1	350 MCM	0.101	0.128	0.29	0.34	0.13	12.4	2.70	0.25	4.9	15.9	4.0
1	500 MCM	0.071	0.092	0.33	0.32	0.12	17.7	3.07	0.19	4.7	22.6	4.4
1	600 MCM	0.059	0.076	0.35	0.31	0.12	21.3	3.32	0.17	4.5	27.2	4.7
1	750 MCM	0.047	0.066	0.38	0.30	0.11	26.6	3.61	0.15	4.4	34.0	5.0
1	1000 MCM	0.035	0.052	0.43	0.29	0.11	35.4	4.03	0.13	4.3	45.3	5.4



OUR CERTIFICATION
ISO 9001 | ISO 14001 | ISO 45001



POLYCAB MV MC SCR ICEA S-93-639 35KV
MV Cable with Aluminium Conductor, EPR Insulation and Copper Screen

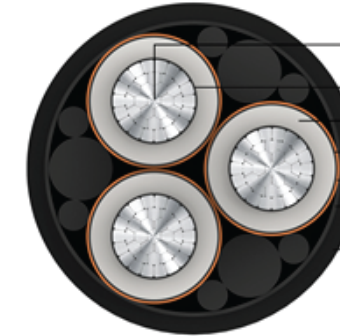

- Stranded Circular Compacted Copper Conductor
- Extruded Semi-Conducting Compound
- Extruded EPR Insulation
- Extruded Semi-Conducting Compound
- Helically applied Copper Tape
- Wrapping Tape
- Extruded Polyvinyl Chloride Outer Sheath

Outstanding Features

- Flame retardant
- High life
- Sunlight resistant
- Oil, Acid and Alkalies resistant
- Corona resistant
- Treeing resistant
- Moisture resistant

Application

POLYCAB MV 35KV EPR insulated with Aluminium conductor Three core cable is suitable to use in conduits, ducts, troughs, trays, direct burial in wet and dry conditions for power supply to wide networks.

Voltage Rating

Nominal Voltage: 35kV AC

Operation Temperature

Operating temperature: -35°C to +105°C
Emergency operating temperature: 140°C
Max. Short Circuit Temperature: 250°C

Construction

- Conductor: Circular Compacted Aluminium conductor as per ASTM B496
- Conductor Screen: Extruded Semi-conductive compound
- Insulation: Extruded EPR (TR-XLPE will be provided on demand)
- Insulation Screen: Extruded Semi-conductive compound
- Metallic Insulation Screen: Helically applied copper tape (*Round / Corrugated copper screen will be provided on demand*)
- Cores assembled together along with fillers (and ground wire optional)
- Binder: Wrapping tape (*Armour will be provided on demand*)
- Outer Sheath: Extruded Polyvinyl Chloride, Colour: Black (*Alternative Sheath: CPE Outer Sheath or LSZH Outer sheath, and parameters will change accordingly*)

Bending Radius: 7D

D is overall diameter of cable

Standard and References:

- ASTM B496
- ICEA S-93-639 (NEMA WC-74)
- UL 1072
- UL 1685 / FT-1
- IEEE 1202
- UL 2556

Voltage Rating (kV AC)	High Voltage Test (kV AC)	
	100% level	133% level
35	69	84

Compliance

- Conductor resistance ICEA S-93-639
- Insulation resistance ICEA S-93-639
- Vertical Tray Flame UL 1685
- Smoke Release UL 1685
- Flame Test IEEE 1202



OUR CERTIFICATION
ISO 9001 | ISO 14001 | ISO 45001



POLYCAB MV MC SCR ICEA S-93-639 35KV
MV Cable with Aluminium Conductor, EPR Insulation and Copper Screen

DIMENSIONS, WEIGHT AND AMPACITY:

133% insulation:

Product Code	No. of Cores	Core Cross sectional Area	Nominal Diameter			Weight (Approx.)	Current rating *	
			Under metallic screen	Over metallic screen	Overall		Directly buried in ground	In air
	No.	AWG / MCM	mm	mm	mm	Kg/Km	Amps	
MVIC46ARUAYF001C002AA001P	3	2 AWG	30.6	31.1	74.0	4850	105	120
MVIC46ARUAYF001C001AA001P	3	1 AWG	31.4	31.9	75.8	5050	115	140
MVIC46ARUAYF001C1X0AA001P	3	1/0 AWG	32.4	32.9	77.8	5350	140	165
MVIC46ARUAYF001C2X0AA001P	3	2/0 AWG	33.4	33.9	80.1	5750	155	190
MVIC46ARUAYF001C3X0AA001P	3	3/0 AWG	34.6	35.1	82.6	6100	175	215
MVIC46ARUAYF001C4X0AA001P	3	4/0 AWG	35.9	36.4	85.5	6550	210	250
MVIC46ARUAYF001C250CA001P	3	250 MCM	37.2	37.7	88.3	7000	230	280
MVIC46ARUAYF001C350CA001P	3	350 MCM	39.6	40.1	93.5	7950	265	355
MVIC46ARUAYF001C500CA001P	3	500 MCM	42.7	43.2	100.0	9200	355	430
MVIC46ARUAYF001C600CA001P	3	600 MCM	45.2	45.7	105.6	10300	390	485
MVIC46ARUAYF001C750CA001P	3	750 MCM	47.6	48.1	110.8	11450	440	555
MVIC46ARUAYF001C01KCA001P	3	1000 MCM	51.2	51.7	118.4	13200	505	665

100% insulation

Product Code	No. of Cores	Core Cross sectional Area	Nominal Diameter			Weight (Approx.)	Current rating *	
			Under metallic screen	Over metallic screen	Overall		Directly buried in ground	In air
	No.	AWG / MCM	mm	mm	mm	Kg/Km	Amps	
MVIC46ARUAYF001C002AA002P	3	2 AWG	26.8	27.3	64.5	3800	105	120
MVIC46ARUAYF001C001AA002P	3	1 AWG	27.6	28.1	66.3	4000	115	140
MVIC46ARUAYF001C1X0AA002P	3	1/0 AWG	28.5	29.1	68.4	4250	140	165
MVIC46ARUAYF001C2X0AA002P	3	2/0 AWG	29.6	30.1	70.6	4600	155	190
MVIC46ARUAYF001C3X0AA002P	3	3/0 AWG	30.8	31.3	74.4	5150	175	215
MVIC46ARUAYF001C4X0AA002P	3	4/0 AWG	32.1	32.6	77.2	5600	210	250
MVIC46ARUAYF001C250CA002P	3	250 MCM	33.4	33.9	80.0	6000	230	280
MVIC46ARUAYF001C350CA002P	3	350 MCM	35.8	36.3	85.3	6850	265	355
MVIC46ARUAYF001C500CA002P	3	500 MCM	38.8	39.4	91.8	8100	355	430
MVIC46ARUAYF001C600CA002P	3	600 MCM	40.9	41.4	96.2	8950	390	485
MVIC46ARUAYF001C750CA002P	3	750 MCM	43.3	43.8	101.4	10000	440	555
MVIC46ARUAYF001C01KCA002P	3	1000 MCM	46.8	47.3	109.0	11700	505	665

* Current Rating based on Table 310.16 (20°C Ambient Ground Temperature) and Table 310.17 (30°C Ambient Air Temperature) of National Electric Code



POLYCAB MV MC SCR ICEA S-93-639 35KV
MV Cable with Aluminium Conductor, EPR Insulation and Copper Screen

ELECTRICAL CHARACTERISTICS:

133% insulation:

No. of Cores	Core Cross sectional Area	Nom. DC Resistance at 25°C	Nom. AC Resistance at 90°C	Approx. Capacitance	Approx. Inductance	Approx. Reactance	Max. pulling tension on conductor	Charging Current per phase	Positive sequence impedance	Electric Stress at Conductor Screen	Short circuit rating	
											Phase conductor	Metallic screen
No.	AWG / MCM	Ω/km	Ω/km	μF/km	mH/km	Ω/km	kN	Amps/Km	Ohms/Km	kV/mm	kA/S	
1	2 AWG	0.531	0.666	0.13	0.51	0.19	1.7	1.66	1.12	7.1	3.0	3.9
1	1 AWG	0.423	0.528	0.13	0.49	0.19	2.1	1.76	0.89	6.7	3.8	4.0
1	1/0 AWG	0.335	0.420	0.14	0.47	0.18	2.7	1.87	0.72	6.4	4.8	4.1
1	2/0 AWG	0.266	0.331	0.15	0.45	0.17	3.4	1.99	0.58	6.1	6.0	4.3
1	3/0 AWG	0.211	0.266	0.16	0.43	0.16	4.3	2.12	0.46	5.8	7.6	4.4
1	4/0 AWG	0.167	0.210	0.17	0.41	0.16	5.4	2.27	0.38	5.5	9.6	4.6
1	250 MCM	0.141	0.177	0.18	0.40	0.15	6.4	2.41	0.33	5.3	11.3	4.7
1	350 MCM	0.101	0.128	0.20	0.38	0.14	8.9	2.68	0.26	5.0	15.9	5.0
1	500 MCM	0.071	0.092	0.23	0.36	0.14	12.8	3.01	0.20	4.7	22.6	5.4
1	600 MCM	0.059	0.076	0.25	0.35	0.13	15.3	3.28	0.18	4.5	27.2	5.7
1	750 MCM	0.047	0.066	0.27	0.34	0.13	19.2	3.54	0.16	4.4	34.0	6.1
1	1000 MCM	0.035	0.052	0.30	0.32	0.12	25.5	3.91	0.14	4.2	45.3	6.5

100% insulation:

No. of Cores	Core Cross sectional Area	Nom. DC Resistance at 25°C	Nom. AC Resistance at 90°C	Approx. Capacitance	Approx. Inductance	Approx. Reactance	Max. pulling tension on conductor	Charging Current per phase	Positive sequence impedance	Electric Stress at Conductor Screen	Short circuit rating	
											Phase conductor	Metallic screen
No.	AWG / MCM	Ω/km	Ω/km	μF/km	mH/km	Ω/km	kN	Amps/Km	Ohms/Km	kV/mm	kA/S	
1	2 AWG	0.531	0.666	0.14	0.48	0.18	1.7	1.86	1.11	7.8	3.0	3.4
1	1 AWG	0.423	0.528	0.15	0.46	0.18	2.1	1.97	0.89	7.5	3.8	3.5
1	1/0 AWG	0.335	0.420	0.16	0.45	0.17	2.7	2.10	0.71	7.1	4.8	3.7
1	2/0 AWG	0.266	0.331	0.17	0.42	0.16	3.4	2.25	0.57	6.8	6.0	3.8
1	3/0 AWG	0.211	0.266	0.18	0.41	0.15	4.3	2.41	0.46	6.5	7.6	3.9
1	4/0 AWG	0.167	0.210	0.20	0.39	0.15	5.4	2.58	0.38	6.2	9.6	4.1
1	250 MCM	0.141	0.177	0.21	0.38	0.14	6.4	2.75	0.33	6.0	11.3	4.3
1	350 MCM	0.101	0.128	0.23	0.36	0.14	8.9	3.07	0.25	5.7	15.9	4.6
1	500 MCM	0.071	0.092	0.26	0.34	0.13	12.8	3.47	0.20	5.4	22.6	4.9
1	600 MCM	0.059	0.076	0.28	0.33	0.13	15.3	3.73	0.18	5.2	27.2	5.2
1	750 MCM	0.047	0.066	0.31	0.32	0.12	19.2	4.04	0.16	5.1	34.0	5.5
1	1000 MCM	0.035	0.052	0.34	0.31	0.12	25.5	4.49	0.14	4.9	45.3	5.9

